

Allied Health Chemistry

Foundations of General, Organic, and Biological Chemistry

Hadeel A. Abozenadah • Adam H. Bishop • Scott D. Bittner • Patricia M. Flatt

Edited By: Stacy Henle

Welcome to the open education resource for Allied Health Chemistry. The focus of this textbook is to introduce students to the foundations of General, Organic and Biological Chemistry and prepare students to be successful in health-related degree programs. The first part of the textbook focuses on the basic fundamentals of measurements in chemistry, the scientific method, an introduction into atoms, elements and trends of the periodic table. The second part of the textbook focuses on chemical bond formation, chemical reactions, and an introduction to organic chemistry. The relationship of concepts to biological systems is carried throughout the text with a focus on medical and health-related aspects. This text was designed for a 10-week course.

This text is published by Western Oregon University under Creative Commons Licensing as: Attribution-Non-Commercial-Share Alike (CC BY-NC-SA 4.0) on Dec 15th, 2018

To share or adapt this content please reference:

Abozenadah, H., Bishop, A., Bittner, S. and Flatt, P.M. (2018) Allied Health Chemistry. CC BY-NC-SA. Available at: <https://www.wou.edu/chemistry/courses/online-chemistry-textbooks/ch103-allied-health-chemistry/>

This text was edited by: Stacy Henle

Contents

Chapter 1: Math for Allied Health Chemistry	6
Section 1.1: Scientific Notation	6
Section 1.2: Units of Measurement	10
Section 1.3: Making Measurements in the Lab	19
Section 1.4: Chapter Summary	31
Section 1.5: Chapter 1 References	32
Chapter 2: Atoms and the Periodic Table	33
Section 2.1: Chemistry and Matter	33
Section 2.2: How Scientists Study Chemistry	43
Section 2.3: Atomic Theory with Historical Perspectives	45
Section 2.4 Introduction to Elements and the Periodic Table	46
Section 2.5 Dmitri Mendeleev and The Periodic Table	50
Section 2.6 Families of the Periodic Table	51
Section 2.7 Defining the Atom	53
Section 2.8 Atomic Number - Protons Determine the Identity of an Element	57
Section 2.9 Atomic Mass, Isotopes, and Molar Mass	58
Section 2.10 Periodic Table Trends	62
Section 2.10 Chapter Summary	68
Section 2.11 References	70
Chapter 3: Radioactivity and Nuclear Chemistry	72
Section 3.1: Major Forms of Radioactivity	73
Section 3.2: Radioactive Half Lives	80
Section 3.3: Biological Effects of Radiation Exposure	81
Section 3.4: Uses of Radioactive Isotopes	83
Section 3.5: Chapter Summary	90

Section 3.6: References	91
Chapter 4: Ions and Ionic Compounds.....	93
Section 4.1: Introduction to the Octet Rule.....	93
Section 4.2: Ions and the Periodic Table	96
Section 4.3: Ionic Bonding.....	103
Section 4.4: Practice Writing Correct Ionic Formulas	105
Section 4.5: Naming Ions and Ionic Compounds.....	108
Section 4.6: Polyatomic Ions	109
Section 4.7: Naming Polyatomic Ions.....	114
Section 4.8: Properties and Types of Ionic Compounds.....	116
Section 4.9 Arrhenius Acids and Bases.....	117
Section 4.10: Ions, Neurons and Actions Potentials.....	119
Section 4.11: Chapter Summary	128
Section 4.12: References.....	130
Chapter 5: Covalent Bonds and Introduction to Organic Molecules.....	132
Section 5.1: Introduction to Covalent Molecules and Compounds.....	132
Section 5.2: Electron Sharing	135
Section 5.3: Electronegativity and Bond Polarity	145
Section 5.4: Properties of Molecular Compounds.....	152
Section 5.5: Naming Binary Molecular Compounds.....	153
Section 5.6: Intermolecular Forces	155
Section 5.7: Recognizing and Drawing Organic Molecules	166
Section 5.8: Stereoisomers, Enantiomers, and Chirality.....	176
Section 5.9: The Importance of Chirality in Protein Interactions	188
Section 5.10: Common Organic Functional Groups.....	191
Section 5.11: Chapter Summary	204
Section 5.12: References.....	205

Chapter 6: Natural Products and Organic Chemistry	208
Section 6.1: Definition and Uses	208
Section 6.2: Primary metabolites	209
Section 6.3: Lipids	210
Section 6.4: Carbohydrates	220
Section 6.5: Proteins	231
Section 6.6: Nucleic Acids	247
Section 6.7: Secondary metabolites	250
Section 6.8: Where Do We Find Secondary Natural Products?	251
Section 6.9: Chapter Summary	274
Section 6.10: References	275
Chapter 7: Chemical Reactions in Biological Systems	277
Section 7.1: What is Metabolism?	277
Section 7.2: Common Types of Biological Reactions	278
Section 7.3: Oxidation and Reduction Reactions and the Production of ATP	292
Section 7.4: Reaction Spontaneity	304
Section 7.5: Enzyme-Mediated Reactions	305
Section 7.6: Introduction to Pharmacology	310
Section 7.7: Chapter Summary	313
Section 7.8: References	315
Chapter 8: Homeostasis and Cellular Function	317
Section 8.1: The Concept of Homeostasis	317
Section 8.2: Disease as a Homeostatic Imbalance	324
Section 8.3: Measuring Homeostasis to Evaluate Health	328
Section 8.4: Solubility	330
Section 8.5: Solution Concentration	333
Section 8.6: Dilutions	346

Section 8.7: Ion Concentrations in Solution	349
Section 8.8: Movement of Molecules Across the Membrane	352
Section 8.9: Summary	363
Section 8.10: Practice Questions	365
Section 8.11: References	370

Chapter 1: Math for Allied Health Chemistry

Section 1.1: Scientific Notation

The study of chemistry can involve numbers that are very large. It can also involve numbers that are very small. Writing out such numbers and using them in their long form is problematic, because we would spend far too much time writing zeroes, and we would probably make a lot of mistakes! There is a solution to this problem. It is called scientific notation.

Scientific notation allows us to express very large and very small numbers using powers of 10.

Recall that:

$$10^0 = 1$$

$$10^1 = 10$$

$$10^2 = 100$$

$$10^3 = 1000$$

$$10^4 = 10000$$

$$10^5 = 100000$$

As you can see, the power to which 10 is raised is equal to the number of zeroes that follow the 1. This will be helpful for determining which exponent to use when we express numbers using scientific notation.

Let us take a very large number:

579, 000, 000, 000

and express it using scientific notation.

First, we find the coefficient, which is a number between 1 and 10 that will be multiplied by 10 raised to some power.

Our coefficient is: 5.79

This number will be multiplied by 10 that is raised to some power. Now let us figure out what power that is.

We can do this by counting the number of positions that stand between the end of the original number and the new position of the decimal point in our coefficient.

5 . 7 9 0 0 0 0 0 0 0 0 0



How many positions are there?

We can see that there are 11 positions between our decimal and the end of the original number. This means that our coefficient, 5.79, will be multiplied by 10 raised to the 11th power.

Our number expressed in scientific notation is:

5.79×10^{11}

But what about very small numbers?

You may recall that:

$10^{-1} = 0.1$

$10^{-2} = 0.01$

$10^{-3} = 0.001$

$10^{-4} = 0.0001$

$10^{-5} = 0.00001$

The number of spaces to the right of the decimal point for our 1 is equal to the number in the exponent that is behind the negative sign. This is useful to keep in mind when we express very small numbers in scientific notation.

Here is a very small number:

0.0000642

Let us express this number using scientific notation.

Our coefficient will be 6.42

This number will be multiplied by 10 raised to some power, which will be negative. Let us figure out the correct power. We can figure this out by counting how many positions

stand between the decimal point in our coefficient and the decimal point in our original number.

0 . 0 0 0 0 6 4 2

↑ ↑

How many positions?

There are 5 positions between our new decimal point and the decimal point in the original number, so our coefficient will be multiplied by 10 raised to the negative 5th power.

Our number written in scientific notation is:

6.42×10^{-5}

You can use these methods to express any large or small number using scientific notation.

Section 1.2: Units of Measurement

Table 1.2: The Seven Base SI Units

Property	Unit	Abbreviation
Length	meter	m
Mass	kilogram	kg
Time	seconds	s
Amount	mole	mol
Temperature	kelvin	K
electric current	ampere	amp
luminous intensity	candella	cd

based on physical standards. The definitions of the SI base units have been and continue to be modified and new base units added as advancements in science are made. Each SI base unit except the kilogram is described by stable properties of the universe.

There are seven base units, which are listed in Table 1.2. Chemistry primarily uses five of the base units: the mole for amount, the kilogram for mass, the meter for length, the second for time, and the kelvin for temperature. The degree Celsius (°C) is also commonly used for temperature. The numerical relationship between kelvins and degrees Celsius is as follows

$$K = ^\circ C + 273$$

The size of each base unit is defined by international convention. For example, the kilogram is defined as the quantity of mass of a special metal cylinder kept in a vault in France (Figure 1.1). The other base units have similar definitions. The sizes of the base units are not always convenient for all measurements. For example, a meter is a rather large unit for describing the width of something

International System of Units and the Metric System

The International System of Units, abbreviated SI from the French *Système International D'unités*, is the main system of measurement units used in science. Since the 1960s, the International System of Units has been internationally agreed upon as the standard metric system. The SI base units are



Figure 1.1 The Kilogram.

The standard for the kilogram is a platinum-iridium cylinder kept in a special vault in France. Source: Wikimedia (https://commons.wikimedia.org/wiki/File:National_prototype_kilogram_K20_replica.jpg)

as narrow as human hair. Instead of reporting the diameter of hair as 0.00012 m or even 1.2×10^{-4} m, SI also provides a series of prefixes that can be attached to the units, creating units that are larger or smaller by powers of 10, known as the metric system.

Common prefixes and their multiplicative factors are listed in Table 1.3 “Prefixes Used with SI Units”. (Perhaps you have already noticed that the base unit kilogram is a combination of a prefix, kilo- meaning 1,000 ×, and a unit of mass, the gram.) Some prefixes create a multiple of the original unit: 1 kilogram equals 1,000 grams (or 1 kg = 1,000 g), and 1 megameter equals 1,000,000 meters (or 1 Mm = 1,000,000 m). Other prefixes create a

Table 1.3: Prefixes used with SI Units

Prefix	Abbreviation	Multiplicative Factor	Multiplicative Factor in Scientific Notation
giga-	G	1,000,000,000 X	10^9X
mega-	M	1,000,000 X	10^6X
kilo-	k	1,000 X	10^3X
deca-	D	10 X	10^1X
X Base (gram, meter, liter, mole, etc)			
deci-	d	1/10 X	$10^{-1}X$
centi-	c	1/100 X	$10^{-2}X$
milli-	m	1/1,000 X	$10^{-3}X$
micro-	μ	1/1,000,000 X	$10^{-6}X$
nano-	n	1/1,000,000,000 X	$10^{-9}X$
pico-	p	1/1,000,000,000,000 X	$10^{-12}X$
femto-	f	1/1,000,000,000,000,000 X	$10^{-15}X$

fraction of the original unit. Thus, 1 centimeter equals 1/100 of a meter, 1 millimeter equals 1/1,000 of a meter, 1 microgram equals 1/1,000,000 of a gram, and so forth.

sometimes this chart can be a little difficult to effectively use when preparing your conversion factors. Thus, Table 1.3a below gives an example of the correct conversions using the gram as the base unit. In addition, the larger unit, tera- is also included.

Table 1.3a Example of Metric Conversions Using the Gram as the Base Unit

Prefix	Abbr.	example using g as base unit	conversion nearest neighbor
tera-	T	1,000,000,000,000 g = 1 Tg	1,000 Gg = 1 Tg
giga-	G	1,000,000,000 g = 1 Gg	1,000 Mg = 1 Gg
mega-	M	1,000,000 g = 1 Mg	1,000 kg = 1 Mg
kilo-	k	1,000 g = 1 kg	100 Dg = 1 kg
deca-	D	10 g = 1 Dg	
		base unit	
deci-	d	10 dg = 1 g	
centi-	c	100 cg = 1 g	10 cg = 1 dg
milli-	m	1,000 mg = 1 g	10 mg = 1 cg
micro-	μ	1,000,000 μg = 1 g	1,000 μg = 1 mg
nano-	n	1,000,000,000 ng = 1 g	1,000 ng = 1 μg
pico-	p	1,000,000,000,000 pg = 1 g	1,000 pg = 1 ng
femto-	f	1,000,000,000,000,000 = 1 g	1,000 fg = 1 pg

Mass

The basic unit of mass in the International System of Units is the kilogram. A kilogram is equal to 1000 grams. A gram is a relatively small amount of mass and so larger masses are often expressed in kilograms. When very tiny amounts of matter are measured, we often use milligrams which are equal to 0.001 gram. There are numerous larger, smaller, and intermediate mass units that may also be appropriate. At the end of the 18th century, a kilogram was the mass of a liter of water. In 1889, a new international prototype of the kilogram was made of a platinum-iridium alloy. The kilogram is equal to the mass of this international prototype, which is held in Paris, France.

Mass and weight are not the same thing. Although we often use the terms mass and weight interchangeably, each one has a specific definition and usage. The mass of an object is a measure of the amount of matter in it. The mass (amount of matter) of an object remains the same regardless of where the object is placed. For example, moving a brick to the moon does not cause any matter in it to disappear or be removed.

The weight of an object is determined by the force that gravitation exerts upon the object. The weight is equal to the mass of the object times the local acceleration of gravity. Thus, on the Earth, weight is determined by the force of attraction between the object and the Earth. Since the force of gravity is not the same at every point on the Earth's surface, the weight of an object is not constant. The gravitational pull on the object varies depending on where the object is with respect to the Earth or other gravity-producing object. For example, a man who weighs 180 pounds on Earth would weigh only 45 pounds if he were in a stationary position, 4,000 miles above the Earth's surface. This same man would weigh only 30 pounds on the moon because the moon's gravity is only one-sixth that of Earth. The mass of this man, however, would be the same in each situation. For scientific experiments, it is important to measure the mass of a substance rather than the weight to retain consistency in the results regardless of where you are performing the experiment.

Length

The SI unit of length is the meter. In 1889, the definition of the meter was a bar of platinum-iridium alloy stored under conditions specified by the International Bureau of Standards. In 1960, this definition of the standard meter was replaced by a definition based on a wavelength of krypton-86 radiation. In 1983, that definition was replaced by

the following: the meter is the length of the path traveled by light in a vacuum during a time interval of a second.

Temperature

When used in a scientific context, the words heat and temperature do NOT mean the same thing. Temperature represents the average kinetic energy of the particles that make up a material. Increasing the temperature of a material increases its thermal energy. Thermal energy is the sum of the kinetic and potential energy in the particles that make up a material. Objects do not “contain” heat; rather they contain thermal energy. Heat is the movement of thermal energy from a warmer object to a cooler object. When thermal energy moves from one object to another, the temperature of both objects change.

A thermometer is a device that measures temperature. The name is made up of “thermo” which means heat and “meter” which means to measure. The temperature of a substance is directly proportional to the average kinetic energy it contains. In order for the average kinetic energy and temperature of a substance to be directly proportional, it is necessary that when the temperature is zero, the average kinetic energy must also be zero. It was necessary for use in calculations in science for a third temperature scale in which zero degrees corresponds with zero kinetic energy, that is, the point where molecules cease to move. This temperature scale was designed by Lord Kelvin. Lord Kelvin stated that there is no upper limit of how hot things can get, but there is a limit as to how cold things can get. In 1848, William Lord Kelvin developed the idea of absolute zero, which is the temperature at which molecules stop moving and therefore, have zero kinetic energy. This is known as the Kelvin temperature scale.

The Celsius scale is based on the freezing point and boiling point of water. Thus, 0°C is the freezing point of water, whereas 100°C is the boiling point of water. Most of us are familiar with temperatures that are below the freezing point of water. It should be apparent that even though the air temperature may be -5°C, the molecules of air are still moving (i.e. 0°C is not absolute zero). Substances like oxygen gas and nitrogen gas have already melted and boiled to vapor at temperatures below -150°C.

The Fahrenheit scale is also defined by the freezing point and boiling points of water. However, the scale is different from that of the Kelvin and Celsius scales. In the Fahrenheit scale, the freezing point of water is 32°F and the boiling point of water is 212°F. To convert between the Fahrenheit scale and the Celsius scale, the following conversions can be used:

$$[^{\circ}\text{C}] = ([^{\circ}\text{F}] - 32) \times 5/9 \quad \text{or} \quad [^{\circ}\text{F}] = [^{\circ}\text{C}] \times 9/5 + 32$$

The Kelvin temperature scale has its zero at absolute zero (determined to be -273.15°C), and uses the same degree scale as the Celsius scale. Therefore, the mathematical relationship between the Celsius scale and the Kelvin scale is

$$\text{K} = ^{\circ}\text{C} + 273.15$$

In the case of the Kelvin scale, the degree sign is not used. Temperatures are expressed simply as 450 K, and are always positive.

Time

The SI unit for time is the second. The second was originally defined as a tiny fraction of the time required for the Earth to orbit the Sun. It has since been redefined several times. The definition of a second (established in 1967 and reaffirmed in 1997) is: the duration of 9,192,631,770 periods of the radiation corresponding to the transition between the two hyperfine levels of the ground state of the cesium-133 atom.

Amount

Chemists use the term mole to represent a large number of atoms or molecules. Just as a dozen implies 12 things, a mole (mol) represents 6.022×10^{23} things. The number 6.022×10^{23} , called Avogadro's number after the 19th-century chemist Amedeo Avogadro, is the number we use in chemistry to represent macroscopic amounts of atoms and molecules. Thus, if we have 6.022×10^{23} Oxygen atoms, we say we have 1 mol of Oxygen atoms. If we have 2 mol of Na atoms, we have $2 \times (6.022 \times 10^{23})$ Na atoms, or 1.2044×10^{24} Na atoms. Similarly, if we have 0.5 mol of benzene (C_6H_6) molecules, we have $0.5 \times (6.022 \times 10^{23})$ C_6H_6 molecules, or 3.011×10^{23} C_6H_6 molecules.

Derived SI Units

Derived units are combinations of SI base units. Units can be multiplied and divided, just as numbers can be multiplied and divided. For example, the area of a square having a side of 2 cm is $2 \text{ cm} \times 2 \text{ cm}$, or 4 cm^2 (read as "four centimeters squared" or "four square

centimeters"). Notice that we have squared a length unit, the centimeter, to get a derived unit for area, the square centimeter.

Table 1.4: Common Conversions Between Metric and English Systems

1 m = 39.36 in = 3.28 ft = 1.09 yd
1 in = 2.54 cm
1 km = 0.62 mi
1 kg = 2.20 lb
1 lb = 454 g
1 L = 1.06 qt
1 L = 0.26 gal

Volume

Volume is an important quantity that uses a derived unit. Volume is the amount of space that a given substance occupies and is defined geometrically as length \times width \times height. Each distance can be expressed using the meter unit, so volume has the derived unit $m \times m \times m$, or m^3 (read as "meters cubed" or "cubic meters"). A cubic meter is a rather large volume, so scientists typically express volumes in terms of 1/1,000 of a cubic meter. This unit has its own name—the liter (L). A liter is a little larger than 1 US quart in volume. (Table 1.4) gives approximate equivalents for some of the units used in chemistry.) As shown in Figure 1.3 "The Liter", a liter is also $1,000 \text{ cm}^3$. By definition, there are 1,000 mL in 1 L, so 1 milliliter and 1 cubic centimeter represent the same volume.

$$\mathbf{1 \text{ mL} = 1 \text{ cm}^3}$$

Energy

Energy, another important quantity in chemistry, is the ability to perform work. Moving a box of books from one side of a room to the other side, for example, requires energy. It has a derived unit of $\text{kg}\cdot\text{m}^2/\text{s}^2$. (The dot between the kg and m^2 units implies the units are multiplied together and then the whole term is divided by s^2 .) Because this

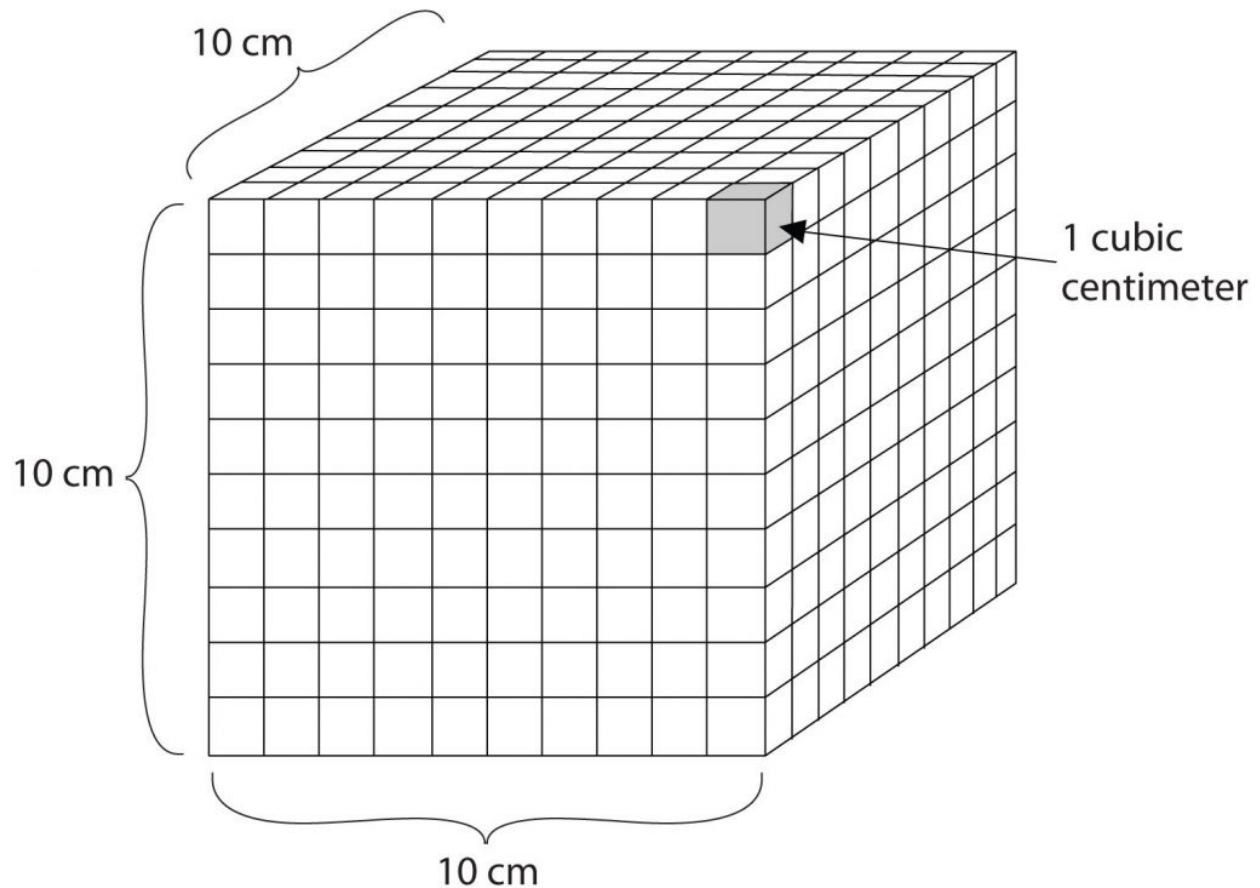

Figure 1.3: Volume and the Liter. A liter is defined as a cube that is 10 cm (1/10th of a meter) on a side. A milliliter, 1/1000th of a liter, is equal to 1 cubic centimeter (1 cm³).

combination is cumbersome, this collection of units is redefined as a joule (J), which is the SI unit of energy. An older unit of energy, the calorie (cal), is also widely used. There are:

$$4.184 \text{ J} = 1 \text{ cal}$$

Note that this differs from our common use of the big 'Calorie' or 'Cal' listed on food packages in the United States. The big 'Cal' is actually a kilocalorie or kcal (Fig 1.4) Note that all chemical processes or reactions occur with a simultaneous change in energy and that energy can be stored in chemical bonds. We can think of this in terms of our food molecules. The chemical bonds in proteins, carbohydrates, and fats store a large amount of energy that our bodies can harvest and convert into usable forms of energy to power brain function, muscle contraction, and build new bone, muscle, and other tissues. This energy can be calculated with proteins yielding 4 Cal/g (4 kcal/g), carbohydrates yielding 4 Cal/g (4 kcal/g), and fats yielding 9 Cal/g (9 kcal/g).

In Scientific terms
this refers to
kilocalories

Nutrition Facts	
Serving Size	1 Bar (35g)
Servings Per Container	6
Amount Per Serving	
Calories	140
	Calories from Fat 40
% Daily Value*	
Total Fat	4.5g 7%
Saturated Fat	1g 5%
Trans Fat	0g
Polyunsaturated Fat	1g
Monounsaturated Fat	2g

Figure 1.4: The Difference between kilocalories in Scientific and Common Use. Calories represented on food packaging actually refer to kilocalories in scientific terms.

Thus, we can calculate the amount of energy that we are receiving from each food source. For example, in the food label presented in Figure 1.4, there is 4.5 g of fat present. We can calculate how many Calories are generated from this fat using our conversion factor of 9 Cal/g for fat.

$$4.5 \text{ g fat} \times \frac{9 \text{ Cal}}{1 \text{ g fat}} = 40.5 \text{ Cal}$$

This matches what the manufacturer indicates on the label (40 Cal coming from fat). Note that the manufacturer is rounding down to the evens in this case. This is the scientific way of rounding and is discussed in more detail below in section 1.3.

Density

Density is defined as the mass of an object divided by its volume; it describes the amount of matter contained in a given amount of space.

$$\text{density} = \text{mass/volume}$$

Thus, the units of density are the units of mass divided by the units of volume: g/cm³ or g/mL (for solids and liquids, respectively), g/L (for gases), kg/m³, and so forth. For example, the density of water is about 1.00 g/mL, while the density of mercury is 13.6 g/mL. Mercury is over 13 times as dense as water, meaning that it contains over 13 times the amount of matter in the same amount of space. The density of air at room temperature is about 1.3 g/L.

Drop Units

Within a hospital setting, medications are often delivered by intravenous fluids (IV). This means that dosages are often calculated by using the number of drops delivered per mL of solution over time. The abbreviation **gtt** is used to denote drop and comes from the Latin word for drop which is gutta. The drop factor (gtt/mL) can be used to determine drip rates when a prescribed volume of medicine is required over a given time period. Note that drop factors will vary depending on the diameter of the IV tubing that is being used.

$$\frac{\text{Volume (mL)}}{\text{Time (min)}} \times \text{Drop Factor (gtt/mL)} = \text{Flow Rate (gtts/min)}$$

Section 1.3: Making Measurements in the Lab

Precision vs. Accuracy

It is important to note the different terminology we use when talking in science. One such set of terminology is precision and accuracy. Although precision and accuracy are often used interchangeably in the non-scientific community, the difference between the terms is extremely important to realize. Precision tells you how close two measurements are to one another, while accuracy tells you how close a measurement is to the known value. A measurement can be precise while not being accurate, or accurate but not precise; the two terms are NOT related. A good analogy can be found in a game of darts (Fig. 1.5). A player who always hits the same spot just to the left of the dart board would be precise but not very accurate. However, a dart player who is all over the board but hits the center

of the board on average would be accurate but not precise. A good darts player, just like a good scientist, wants to be both precise and accurate.

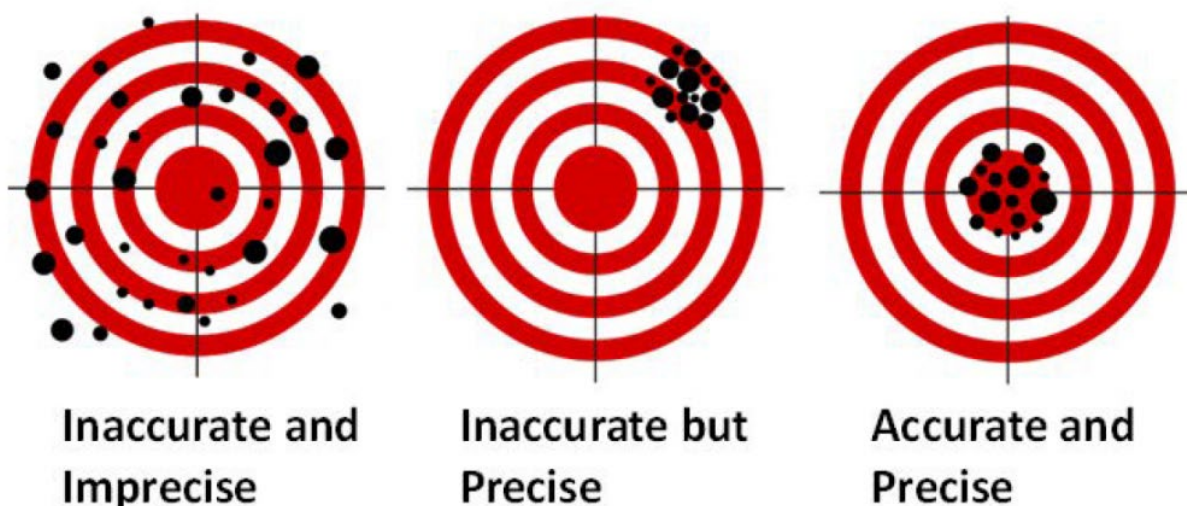

Figure 1.5: Difference Between Accuracy and Precision. A game of darts can be used to show the difference between accuracy and precision.

Adapted from:

https://upload.wikimedia.org/wikipedia/commons/thumb/5/5d/Reliability_and_validity.svg/717px-Reliability_and_validity.svg.png

Typically within the laboratory, accuracy is a measure of how well your equipment is calibrated. For example, if your balance is not calibrated correctly, you can make very precise, repeated measurements, but the measurements will not represent the true value. Precision, on the other hand, is usually determined by how careful the scientist is in making measurements. If you are careless and spill part of your sample on the way, your measurements in repeated experiments will not be precise even if your balance is accurate.

Significant Figures

It is important to realize that values in scientific measurements are never 100% accurate. Our instruments only measure to a certain level of accuracy. Thus, we can pick different instruments to make a measurement based upon the level of accuracy we need for the experiment. Due to the inherent inaccuracy in any measured number we must keep track

of the different levels of accuracy each number has with significant figures. Significant figures of a measured quantity are defined as all the digits known with certainty and the first uncertain, or estimated, digit. It makes no sense to report any digits after the first uncertain one, so it is the last digit reported in a measurement. Zeros are used when needed to place the significant figures in their correct positions. Thus, zeros may or may not be significant figures. Significant figures apply in the real world, as they allow us to quantify the accuracy of any type of measurement. To identify how many numbers in a measurement have significance, you can follow a discreet set of rules, shown below and to the right.

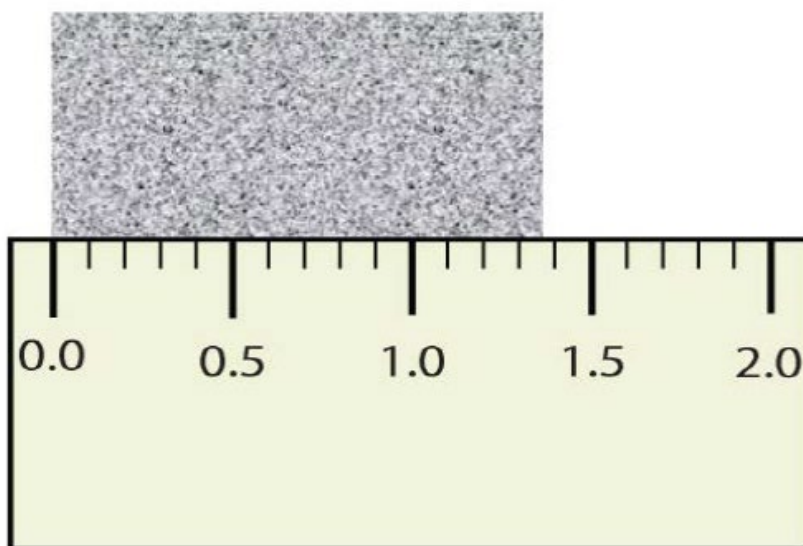

Figure 1.6: Measuring an Object to the Correct Number of Significant Figures.

How many digits should be shown in this measurement?

The correct answer is 3! The two that you know for sure + the estimated position...for this reading it would be close to 1.37

Exact Numbers

Exact numbers are numbers that are not measured by a scientific instrument. They are either used as definitions to define a concept or terminology, or they are made by counting the total of something present. An example of an exact number, would be the number of eggs in a carton or a defined unit such as there are 100 cm in 1 m. Exact numbers, such as the number of people in a room, DO NOT affect the number of significant figures in calculations made with measured values

Think About This!

1. An oceanographer needs to go out in a boat to collect an important temperature and salinity data logger that is attached to an underwater buoy. How does each of the following situations illustrate the differences between precision and accuracy?

a. The oceanographer checks the weather forecast the night before her trip so she knows what to wear on the boat. The TV forecaster says it will be between 26 and 31 degrees (°) Celsius (C) at noon the next day. The actual temperature reading the next day on the boat at noon is 28°C.

b. When the oceanographer uses her Global Positioning System (GPS) indicates that she is at the location of the underwater buoy, she anchors the boat and jumps in the water to collect the data logger. However, she can't see the buoy. The other GPS units belonging to her colleagues on the boat also indicate that they are at the correct location. After an extensive search, the oceanographer finds the buoy 50 meters (m) from the boat.

c. While on the way back to shore, the oceanographer throws in a fishing line to see if she can catch anything for dinner. She is lucky enough to catch a mahi-mahi. When she pulls it out of the water, her colleagues estimate the weight of the fish. Their estimates are 16.1 kilograms (kg), 16.8 kg, and 15.9 kg. When they weigh the fish upon returning to shore, the actual weight is 18.2 kg.

2. Write your own scenario illustrating the difference between accuracy and precision. Swap your scenario with a classmate. Identify your classmate's scenario measurements as accurate or inaccurate and precise or imprecise.

a. A dart player can see how accurate his or her dart throws are by comparing the location of the thrown darts to the target, the bulls-eye of the dartboard.

b. How is this model different from scientists who are measuring a natural phenomenon?

c. Is there a way for scientists to determine how accurate their measurements are? Explain your answer

Rules for Significant Figures

1. Trailing zeros at the end of a number, but to the left of the decimal place can act as the placeholders and may or may not be significant.

Example: 39,800

May have 3, 4, or 5 significant figures!

The researcher that made the measurement must tell you!

2. All non-zero digits are significant

Example: 171

has 3 significant figures

3. Trapped zeroes between non-zero digits are significant

Example: 1,007

has 4 significant digits

4. Leading zeros are not significant

Example: 0.0017

has only 2 significant figures, the zeros to the left of numbers are considered placeholders

5. Trailing zeroes are significant after a decimal

Example: 17.00

has 4 significant figures

6. When numbers are in scientific notation all the numbers are shown are significant

Example: 1.70×10^3

has 3 significant figures.

7. A decimal point at the end of a whole number indicates all values to the left of the decimal are significant.

Example: 100.

has 3 significant figures

Example: 100.0

has 4 significant figures

Rules of Rounding

In scientific operations, the rules of rounding may be a little bit different than the ones you are used to using. Normal rounding rules suggest that if a number is below 5, it should be rounded down to the lower number, whereas if it is 5 or higher, it should be rounded up. However, note that 5 is right in the middle and causes a problem when using these conventional rounding rules. If you have a large dataset of numbers that you need to round, using this rounding rule will lead to bias in your dataset (i.e. 4/9th of the time you will be rounding down, and 5/9th of the time you will be rounding up). In a large dataset, this bias is unacceptable.

Rules of Rounding

The rules used in this course for rounding numbers are known as “rounding to the evens”, and are implemented as follows:

1. Increase the final digit by one unit if the digit dropped is 6 or greater.
2. Leave the final digit unchanged if the digit dropped is 4 or lower.
3. If the number to be dropped is exactly 5 (with no other numbers following it), then the preceding number, if it is odd, is increased by one. If the preceding number is even, it remains the same.

In Scientific Rounding, we typically use a rule called ‘Rounding to the Even.’ In this rounding system the rules are the same for a number below 5, you round down to the lower number, and for numbers above 5 you round up to the higher number. That means if the number you are rounding is 5 and it has any following numbers, all of the excess

digits are dropped and the last retained digit is increased by one. However, if the number you are rounding is exactly 5 or 5 with only zeros following it, then you round to the even number. This helps to alleviate the sample bias that can occur when rounding large datasets.

Example 1:

Round 26.65 to three significant figures.

Solution:

When you look at the 4th digit, it is a 5 with no numbers following it. So now you must look at the 3rd digit. In this case it is even, so you would round to the even and the final answer would be 26.6

Example 2:

Round 26.652 to three significant figures.

Solution:

When you look at the 4th digit, it is a 5 with a number following it. In this case both the 5 and the 2 will be dropped and the remaining digit must be increased by one, so you would round the 6 up and the final answer would be 26.7

Example 3:

Round 26.7500 to three significant figures.

Solution:

When you look at the 4th digit, it is a 5 with only zeros following it. So now you must look at the 3rd digit. In this case it is odd, so you would round up to the even and the final answer would be 26.8

Calculations with Significant Figures

The first thing to realize before performing any calculations in science is that all measured numbers are only as good as the instrument used to measure them. Even with the best instrument available the measured number will never be 100% exact. Scientists use the

"good enough" rule of precision, meaning that we accept an inherent amount of imprecision from every measurement we take as long as the final result is close enough to where we want it to be. This concept becomes dangerous when we begin to use these "good enough" numbers for any calculations, if we aren't careful to keep track of our significant figures our numbers can quickly lose their "good enough" status. To protect their "good enough" numbers, the scientific community has set forth certain rules for performing any calculations; in this section we need only concern ourselves with two very important rules: the Addition/Subtraction rule, and the Multiplication/Division rule.

Addition/Subtraction Rule Example

If you had a beaker weighing 50.27 grams and added 2.5 grams of calcium carbonate what would be the total mass of the filled beaker using the correct number of significant figures?

Answer: 52.8 grams

1. Identify the number with the fewest decimal places:

2.5

2. Perform the addition:

$$\begin{array}{r} 50.27 \\ + 2.5 \\ \hline 52.77 \end{array}$$

3. Round your answer to the fewest decimal places (Identified in step 1):

52.77

Rounding Rule: 6 and up rounds up...

Final Answer: 52.8 grams

Don't forget your units!

Addition/Subtraction Rule:

Find the number with the least number of decimals and keep track of the number of decimal places

Perform the addition/subtraction

Round the final answer to the least number of decimals found in Step 1

Multiplication/Division Rule Examples

Suppose you were working with 13.76 milliliters of water mixed with 2.53 milliliters of cooking oil in a graduated cylinder and your lab instructor asked you to find the ratio of water to oil. What would the final answer be with the correct number of significant figures?

First, Recall that Ratios represent division

$$\frac{\text{water}}{\text{oil}}$$

1. Identify the number of significant figures in each measured value

13.76 ml of water = 4 sig figs

2.53 ml of oil = 3 sig figs

***Final Answer needs 3 sig figs!**

2. Perform the math operation:

$$\frac{13.76 \text{ ml water}}{2.53 \text{ ml oil}} = 5.4387$$

3. Round the final answer to the correct number of significant figures found in step 1.

5.4387 is rounded to 5.44 (three significant figures)

The ratio of water:oil = 5.44

Multiplication/Division Rule:

Count the number of significant figures in each number (keep track of the number of significant figures)

Perform the multiplication/division

Round your final answer to the lowest number of significant figures found in step 1

Calculating Complicated Problems:

Using the order of operations, break the problem up into multiple steps

Perform any addition/subtraction steps following the Addition/Subtraction rule (Do not round yet, just keep track of the correct number of decimals when finding the number of significant figures)

Perform multiplication/division using the Multiplication/Division rule

Round the final answer to the correct number of significant figures

Conversions and the Importance of Units

The ability to convert from one unit to another is an important skill. For example, a nurse with 50 mg aspirin tablets who must administer 0.2 g of aspirin to a patient, needs to know that 0.2 g equals 200 mg, so that 4 tablets are needed. Fortunately, there is a simple way to convert from one unit to another.

Conversion Factors

If you learned the SI units and prefixes described in Section 1.4 Units of Measurement", then you know that 1 cm is 1/100th of a meter or:

$$\mathbf{100\text{ cm} = 1\text{ m}}$$

Suppose we divide both sides of the equation by 1 m (both the number and the unit; Note that it is critically important to always write out your units! This avoids confusion and mistakes when making conversions.):

$$\frac{100 \text{ cm}}{1 \text{ m}} = \frac{1 \text{ m}}{1 \text{ m}}$$

As long as we perform the same operation on both sides of the equals sign, the expression remains an equality. Look at the right side of the equation; it now has the same quantity in the numerator (the top) as it has in the denominator (the bottom). Any fraction that has the same quantity in the numerator and the denominator has a value of 1:

$$\frac{100 \text{ cm}}{1 \text{ m}} = \frac{1 \text{ m}}{1 \text{ m}}$$

We know that 100 cm is 1 m, so we have the same quantity on the top and the bottom of our fraction, although it is expressed in different units. A fraction that has equivalent quantities in the numerator and the denominator but expressed in different units is called a conversion factor

$$\frac{100 \text{ cm}}{1 \text{ m}} = 1$$

Note that conversion factors can be written with either term in the numerator or denominator, and used as appropriate for the problem that you want to solve. This is because, both terms are equal to 1

$$\frac{100 \text{ cm}}{1 \text{ m}} = 1 = \frac{1 \text{ m}}{100 \text{ cm}}$$

Here is a simple example. How many centimeters are there in 3.55 m? Perhaps you can determine the answer in your head. If there are 100 cm in every meter, then 3.55 m equals 355 cm. To solve the problem more formally with a conversion factor, we first write the quantity we are given, 3.55 m. Then we multiply this quantity by a conversion factor, which is the same as multiplying it by 1. We can write 1 as 100cm/1m and multiply:

$$3.55 \cancel{\text{ m}} \times \frac{100 \cancel{\text{ cm}}}{1 \cancel{\text{ m}}} = 355 \text{ cm}$$

Because m, the abbreviation for meters, occurs in both the numerator and the denominator of our expression, they cancel out. The final step is to perform the calculation that remains once the units have been canceled. Note that it is CRITICAL to retain the right units in the final answer or it will not make sense. A generalized description of this process is as follows:

$$\text{quantity (old units)} \times \text{conversion factor} = \text{quantity (new units)}$$

You may be wondering why we use a seemingly complicated procedure for a straightforward conversion. In later studies, the conversion problems you will encounter will not always be so simple. If you can master the technique of applying conversion factors, you will be able to solve a large variety of problems.

In the previous example, we used the fraction 100 cm/1 m as a conversion factor. Does the conversion factor 1 m/100 cm also equal 1? Yes, it does; it has the same quantity in the numerator as in the denominator (except that they are flip-flopped). Why did we not use that conversion factor? If we had used the second conversion factor, the original unit would not have canceled, and the result would have been meaningless. Here is what we would have gotten:

$$3.55 \text{ m} \times \frac{1 \text{ m}}{100 \text{ cm}} = 0.0355 \text{ m}^2/\text{cm}$$

INCORRECT USE OF CONVERSION FACTOR!!

You can see that none of the units cancelled out. For the answer to be meaningful, we have to construct the conversion factor in a form that causes the original unit to cancel out. Figure 1.13 "A Concept Map for Conversions" shows a concept map for constructing a proper conversion.

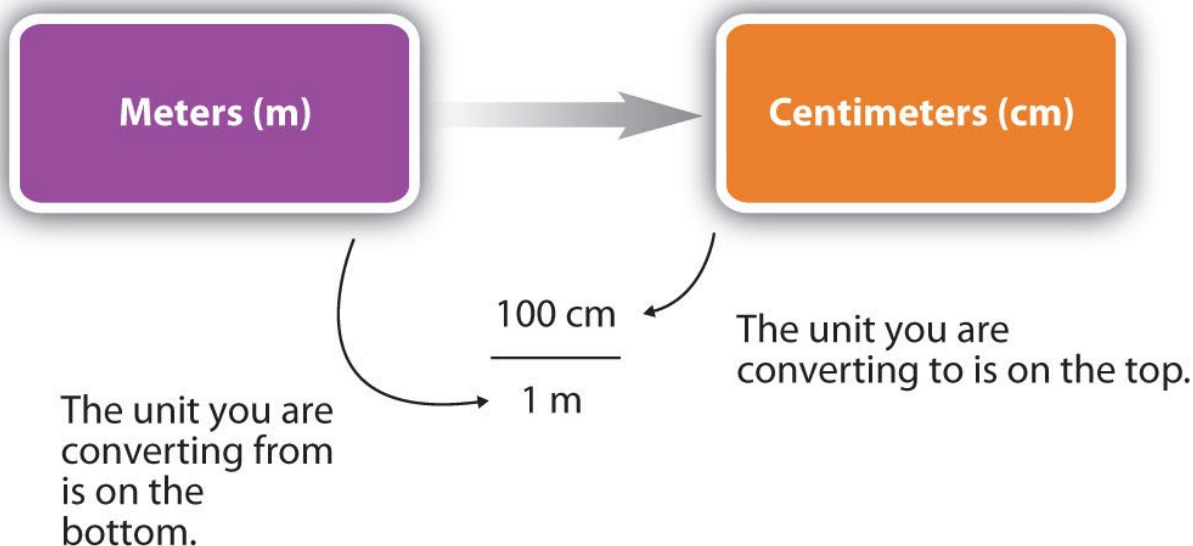

Figure 1.13 A Concept Map for Conversions. This is how you construct a conversion factor to convert from one unit to another.

Section 1.4: Chapter Summary

- **Scientific notation** is a useful way to represent very large and very small numbers. Note that when using scientific notation, that all numbers shown are significant figures.
- **The International System of Units (SI)** and the **Metric System** are the standard units of measurement used when making scientific measurements. These include direct measurements for mass (grams), length (meter), temperature (Celsius), time (second), and amount (mole) and the derived units for volume (liter), energy (joule), and density (mass/volume or g/mL).
- The validity of scientific experiments depend on both **precision** and **accuracy**. **Precision** is a measure of the repeatability of the measurements and is usually dependent on how carefully a researcher performs the experiment. **Accuracy** is a measure of the correctness of the collected or analyzed data and is usually dependent on how well the equipment is calibrated and working at the time of the measurements.
- **Significant figures** are used to indicate the accuracy of scientific measurements and are dependent on the equipment used to make the measurement. **Significant figures** in scientific measurements include the first estimated position of a measurement. No additional estimated positions are included.

- When representing a scientific value using significant figures, it may be necessary to round the number to the correct number of digits. For **scientific rounding**, we use the concept of **rounding to the evens**. For numbers below 5 always round down and for numbers larger than 5 always round up. However, if the number you are rounding is exactly 5 or 5 with only zeros following it, round the previous number to the even number. (i.e. 6.5 would be rounded down to 6, whereas 7.5 would be rounded up to 8)
 - When making calculations, it is necessary to maintain the correct number of **significant figures** within your answer. The least number of decimal places is critical for finding significant figures after addition and subtraction functions, whereas the least number of significant figures within the starting numbers is important for multiplication and division functions. Recall that only measured numbers are used in the determination of significant figures. Exact numbers such as defined units and conversion factors are not used to determine significant figures. It is also important to only round a calculated number at the final step in the calculation.
 - When making calculations, always include the appropriate units within your calculations and utilize appropriate conversion factors when required.
-

Section 1.5: Chapter 1 References

Chapter 1 materials have been adapted and modified from the following creative commons resources unless otherwise noted:

1. Anonymous. (2012) Introduction to Chemistry: General, Organic, and Biological (V1.0). Published under Creative Commons by-nc-sa 3.0. Available at: <http://2012books.lardbucket.org/books/introduction-to-chemistry-general-organic-and-biological/index.html>
2. Poulsen, T. (2010) Introduction to Chemistry. Published under Creative Commons by-nc-sa 3.0. Available at: <http://openedgroup.org/books/Chemistry.pdf>
3. OpenStax (2015) Atoms, Isotopes, Ions, and Molecules: The Building Blocks. OpenStax CNX. Available at: <http://cnx.org/contents/be8818d0-2dba-4bf3-8>

Chapter 2: Atoms and the Periodic Table

Section 2.1: Chemistry and Matter

What is Chemistry?

Everything around us is made up of chemicals. From the color that makes a rose so red to the gasoline that fills our cars and the silicon chips that power our computers and cell phones...Chemistry is everywhere! Understanding how chemical molecules form and interact to create complex structures enables us to harness the power of chemistry and use it, just like a toolbox, to create many of the modern advances that we see today. This includes advances in medicine, communication, transportation, building infrastructure, food science and agriculture, and nearly every other technical field that you can imagine.

Chemistry is one branch of science. **Science** is the process by which we learn about the natural universe by observing, testing, and then generating models that explain our observations. is the process by which we learn about the natural universe by observing, testing, and then generating models that explain our observations. Because the physical universe is so vast, there are many different branches of science (Figure 2.1). Thus, **chemistry** is the study of matter, **biology** is the study of living things, and **geology** is the study of rocks and the earth. **Mathematics and Physics** are the languages of science, and we will use them to communicate some of the ideas of chemistry.

Although we divide science into different fields, there is much overlap among them. For example, some biologists and chemists work in both fields so much that their work is called **biochemistry**. Similarly, geology and chemistry overlap in the field called **geochemistry**. Figure 2.1 shows how many of the individual fields of science are related.

Physical vs. Chemical Properties

Part of understanding matter is being able to describe it. One way chemists describe matter is to assign different kinds of properties to different categories. The properties that chemists use to describe matter fall into two general categories. **Physical properties** are characteristics that describes matter, such as boiling point, melting point and color. Physical Changes, such as melting a solid into a liquid, do not alter the chemical structure of that matter. **Chemical properties** are characteristics that describe how the chemical structure of matter changes during a chemical reaction. An example of a

chemical property is flammability—a materials ability to burn—because burning (also known as combustion) changes the chemical composition of a material.

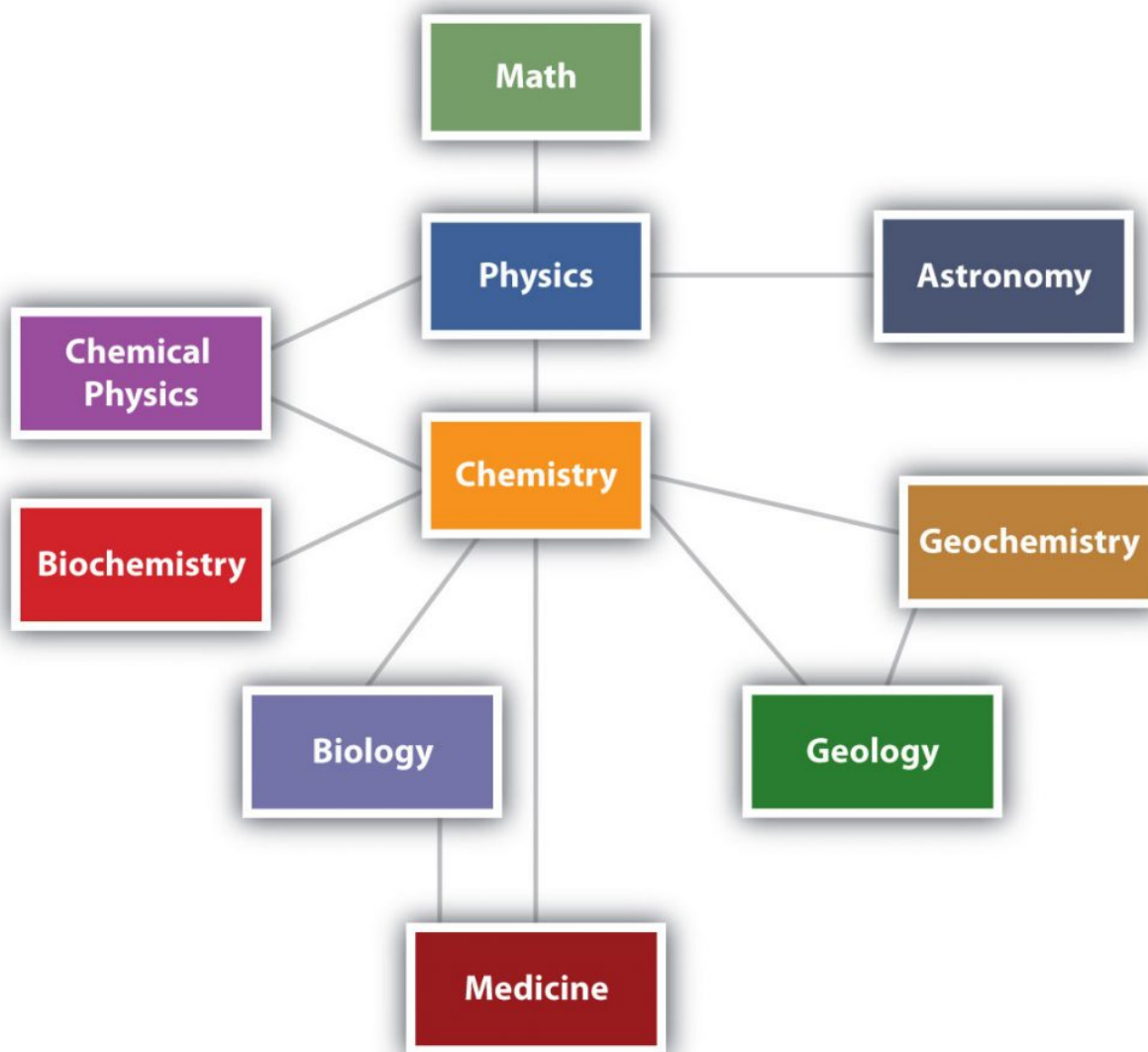

Figure 2.1: The Relationships Between Some of the Major Branches of Science. Chemistry lies more or less in the middle, which emphasizes its importance to many branches of science.

Elements and Compounds

Any sample of matter that has the same physical and chemical properties throughout the sample is called a **substance**. There are two types of substances. A substance that cannot be broken down into chemically simpler components is an **element**. Aluminum, which is used in soda cans, is an element. A substance that can be broken down into chemically simpler components (because it has more than one element) is a **compound**. Water is a compound composed of the elements hydrogen and oxygen. Today, there are about 118 elements in the known universe which are organized on a fundamental chart called the Periodic Table of Elements (Fig. 2.2a). In contrast, scientists have identified tens of millions of different compounds to date.

Periodic Table of the Elements

Group	1	2											13	14	15	16	17	18
1	1 H 1.01 Hydrogen																	2 He 4.00 Helium
2	3 Li 6.94 Lithium	4 Be 9.01 Beryllium											5 B 10.81 Boron	6 C 12.11 Carbon	7 N 14.01 Nitrogen	8 O 15.99 Oxygen	9 F 18.99 Fluorine	10 Ne 20.18 Neon
3	11 Na 22.99 Sodium	12 Mg 24.31 Magnesium											13 Al 26.98 Aluminum	14 Si 28.09 Silicon	15 P 30.97 Phosphorus	16 S 32.07 Sulfur	17 Cl 35.45 Chlorine	18 Ar 39.95 Argon
4	19 K 39.09 Potassium	20 Ca 40.08 Calcium	21 Sc 44.96 Scandium	22 Ti 47.87 Titanium	23 V 50.94 Vanadium	24 Cr 51.99 Chromium	25 Mn 54.94 Manganese	26 Fe 55.85 Iron	27 Co 58.93 Cobalt	28 Ni 58.69 Nickel	29 Cu 63.55 Copper	30 Zn 65.41 Zinc	31 Ga 69.72 Gallium	32 Ge 72.64 Germanium	33 As 74.92 Arsenic	34 Se 78.96 Selenium	35 Br 79.90 Bromine	36 Kr 83.79 Krypton
5	37 Rb 85.47 Rubidium	38 Sr 87.62 Strontium	39 Y 88.91 Yttrium	40 Zr 91.22 Zirconium	41 Nb 92.91 Niobium	42 Mo 95.94 Molybdenum	43 Tc [98] Technetium	44 Ru 101.1 Ruthenium	45 Rh 102.9 Rhodium	46 Pd 106.4 Palladium	47 Ag 107.9 Silver	48 Cd 112.4 Cadmium	49 In 114.8 Indium	50 Sn 118.7 Tin	51 Sb 121.8 Antimony	52 Te 127.6 Tellurium	53 I 126.9 Iodine	54 Xe 131.3 Xenon
6	55 Cs 132.9 Cesium	56 Ba 137.3 Barium	57-71 La-Lu Lanthanides	72 Hf 178.5 Hafnium	73 Ta 180.9 Tantalum	74 W 183.8 Tungsten	75 Re 186.2 Rhenium	76 Os 190.2 Osmium	77 Ir 192.2 Iridium	78 Pt 195.1 Platinum	79 Au 196.9 Gold	80 Hg 200.6 Mercury	81 Tl 204.4 Thallium	82 Pb 207.2 Lead	83 Bi 208.9 Bismuth	84 Po [209] Polonium	85 At [210] Astatine	86 Rn [222] Radon
7	87 Fr [223] Francium	88 Ra [226] Radium	89-103 Ac-Lr Actinides	104 Rf [261] Rutherfordium	105 Db [262] Dubnium	106 Sg [266] Seaborgium	107 Bh [264] Bohrium	108 Hs [277] Hassium	109 Mt [268] Meitnerium	110 Ds [269] Darmstadtium	111 Rg [272] Roentgenium	112 Cn [285] Copernicium	113 Uut [284] Ununtrium	114 Fl [289] Flerovium	115 Uup [288] Ununpentium	116 Lv [293] Livermorium	117 Uus [294] Ununseptium	118 Uuo [294] Ununoctium
			57 La 138.9 Lanthanum	58 Ce 140.1 Cerium	59 Pr 140.9 Praseodymium	60 Nd 144.2 Neodymium	61 Pm [145] Promethium	62 Sm 150.4 Samarium	63 Eu 151.9 Europium	64 Gd 157.3 Gadolinium	65 Tb 158.9 Terbium	66 Dy 162.5 Dysprosium	67 Ho 164.9 Holmium	68 Er 167.3 Erbium	69 Tm 168.9 Thulium	70 Yb 173.1 Ytterbium	71 Lu 174.9 Lutetium	
			89 Ac [227] Actinium	90 Th 232.0 Thorium	91 Pa 231.0 Protactinium	92 U 238.0 Uranium	93 Np [237] Neptunium	94 Pu [244] Plutonium	95 Am [243] Americium	96 Cm [247] Curium	97 Bk [247] Berkelium	98 Cf [251] Californium	99 Es [252] Einsteinium	100 Fm [257] Fermium	101 Md [258] Mendelevium	102 No [259] Nobelium	103 Lr [262] Lawrencium	

Color Code

- Other non-metals
- Noble gases
- Alkali metals
- Lanthanides
- Transition metals
- Actinides
- Other metals
- Unknown chemical properties
- Alkaline earth metals
- Halogens

Atomic Number → 1

Symbol → H

Relative Atomic Mass → 1.01

Name → Hydrogen

Figure 2.2a: The Periodic Table of the Elements is an organized chart that contains all of the known chemical elements.

The smallest part of an element that maintains the identity of that element is called an **atom**. Atoms are extremely tiny; to make a line 1 inch long, you would need 217 million iron atoms! Similarly, the smallest part of a compound that maintains the identity of that compound is called a **molecule**. Molecules are composed of atoms that are attached together and behave as a unit (Fig. 2.2b). Scientists usually work with millions of atoms and molecules at a time. When a scientist is working with large numbers of atoms or molecules at a time, the scientist is studying the macroscopic view of the universe. However, scientists can also describe chemical events on the level of individual atoms or molecules, which is referred to as the microscopic viewpoint. We will see examples of both macroscopic and microscopic viewpoints throughout this book (Figure 2.3).

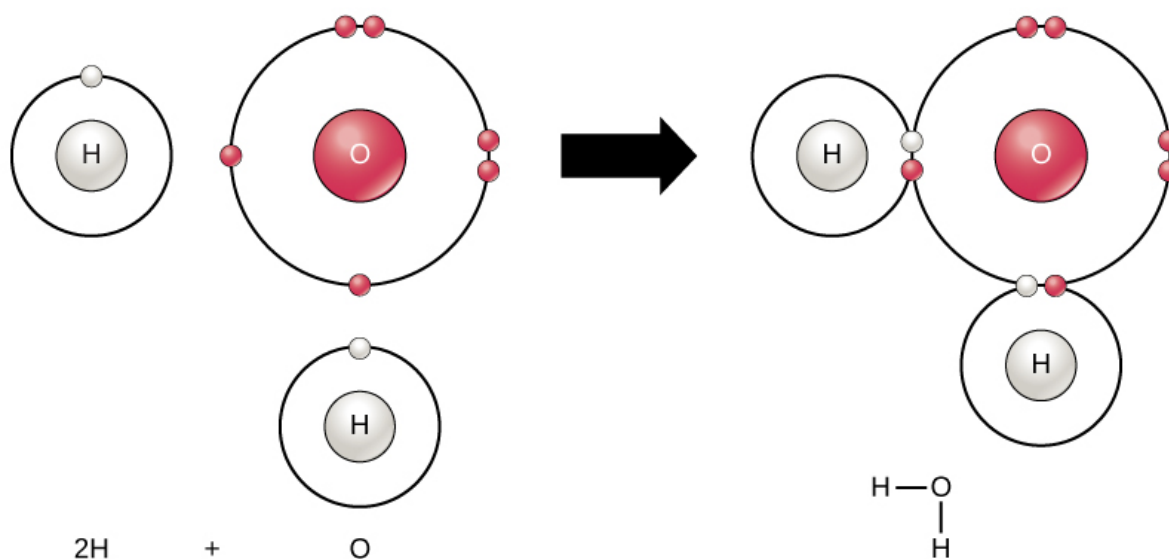

Figure 2.2b: Elements and Molecules. To the left of the arrow is shown one atom of oxygen and two atoms of hydrogen. Each of these represent single elements. When they are combined on the righthand side, they form a single molecule of water (H₂O). Note that water is defined as a compound, because each single molecule is made up of more than one type of element, in this case, one atom of oxygen with two atoms of hydrogen.

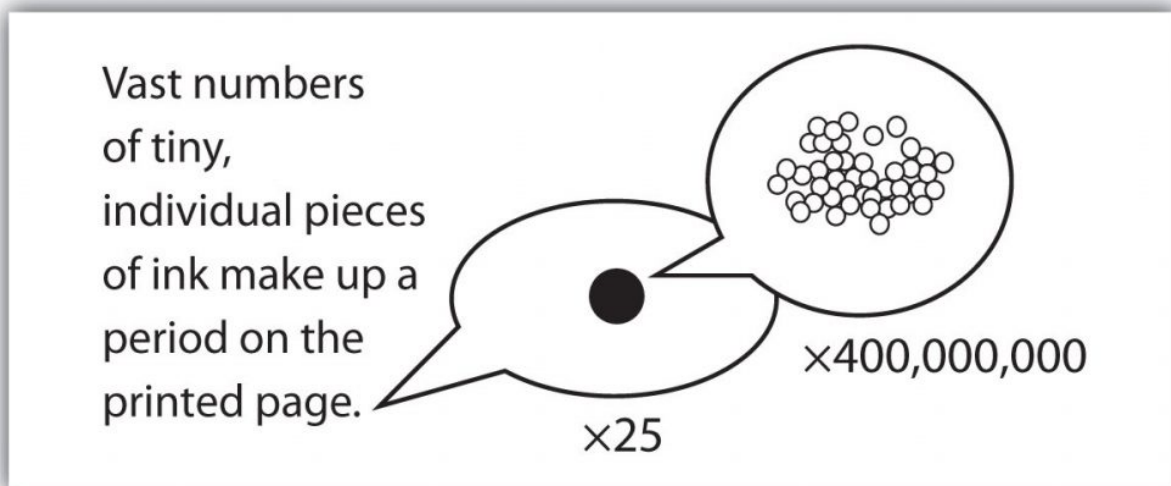
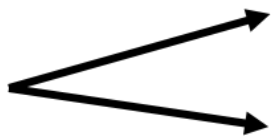

Figure 2.3: How many molecules are needed for a period in a sentence? Although we do not notice it from a macroscopic perspective, matter is composed of microscopic particles so tiny that billions of them are needed to make a speck that we can see with the naked eye. The X25 and X400,000,000 indicate the number of times the image is magnified.

Mixtures

A material composed of two or more substances is a **mixture**. In a mixture, the individual substances maintain their chemical identities. Many mixtures are obvious combinations of two or more substances, such as a mixture of sand and water. Such mixtures are called **heterogeneous mixtures**. In some mixtures, the components are so intimately combined that they act like a single substance even though they are not. Mixtures with a consistent composition throughout are called **homogeneous mixtures**. Homogeneous mixtures that are mixed so thoroughly that neither component can be observed independently of the other are called **solutions**. Sugar dissolved in water is an example of a solution. A metal alloy, such as steel, is an example of a solid solution. Air, a mixture of mainly nitrogen and oxygen, is a gaseous solution.

**Heterogeneous
Mixture**



**Homogeneous
Mixture**



Figure 2.4: Heterogeneous vs. Homogeneous Mixtures. A mixture contains more than one substance. In the upper panel you see an example of a heterogeneous mixture of oil and water. The mixture is heterogeneous because you can visibly see two different components in the mixture. In the lower panel, you see an example of a homogeneous mixture, coffee. It is homogeneous because you cannot distinguish the many different components that make up a cup of coffee (water; caffeine; coffee alkaloids and tannins). It looks the same throughout. If the mixture is homogeneous and is also see through or clear, it is called a solution. In our example, the coffee is a solution; however, a concentrated espresso may be very opaque and would only be homogeneous mixture, not a solution.

States of Matter

Another way to classify matter is to describe it as a **solid**, a **liquid**, or a **gas**, which was done in the examples of solutions, above. These three descriptions, each implying that the matter has certain physical properties, represent the three phases of matter. A **solid** has a definite shape and a definite volume. Liquids have a definite volume but not a definite shape; they take the shape of their containers. **Gases** have neither a definite shape nor a definite volume, and they expand to fill their containers. We encounter matter in

each phase every day. In fact, we regularly encounter water in all three phases: ice (solid), water (liquid), and steam (gas).

We know from our experience with water that substances can change from one phase to another if the conditions are right. Typically, varying the temperature of a substance (and, less commonly, the pressure exerted on it) can cause a phase change or a physical process in which a substance goes from one phase to another (Figure 2.5). Phase changes have particular names depending on what phases are involved, as summarized in Table 1.1.

Table 1.1: Phase Changes

Change	Name
solid to liquid	melting, fusion
solid to gas	sublimation
liquid to gas	boiling, evaporation
liquid to solid	solidification, freezing
gas to liquid	condensation
gas to solid	deposition

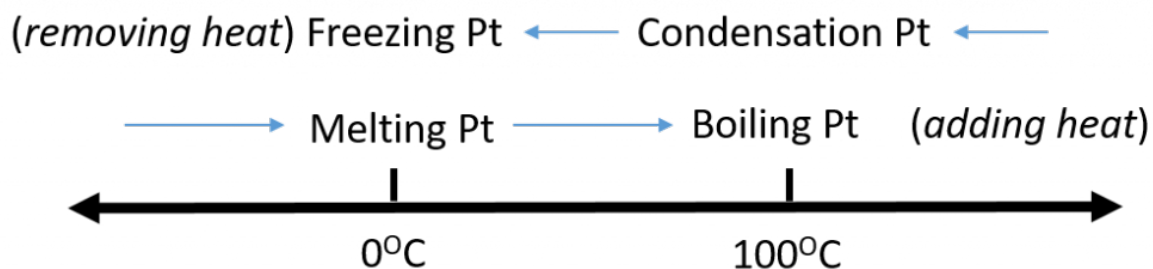

Figure 2.5. Analyzing Phase Changes. (**Upper panel**) A photo of boiling water demonstrates the phase change of water from the liquid to the gaseous phase. Note that phase changes are a physical property of a molecule. The water is still chemically the same (H_2O) in the solid, liquid, or gaseous state. (**Lower panel**) Change in temperature can cause phase changes. Above is the temperature scale for the phase changes of water. If you add heat to solid ice, water will melt at $0^\circ C$ and boil at $100^\circ C$. If you remove heat from gaseous water, it will condense into the liquid state at $100^\circ C$ and freeze at $0^\circ C$.

In summary, Figure 2.6 “The Classification of Matter” illustrates the relationships between the different ways matter can be classified.

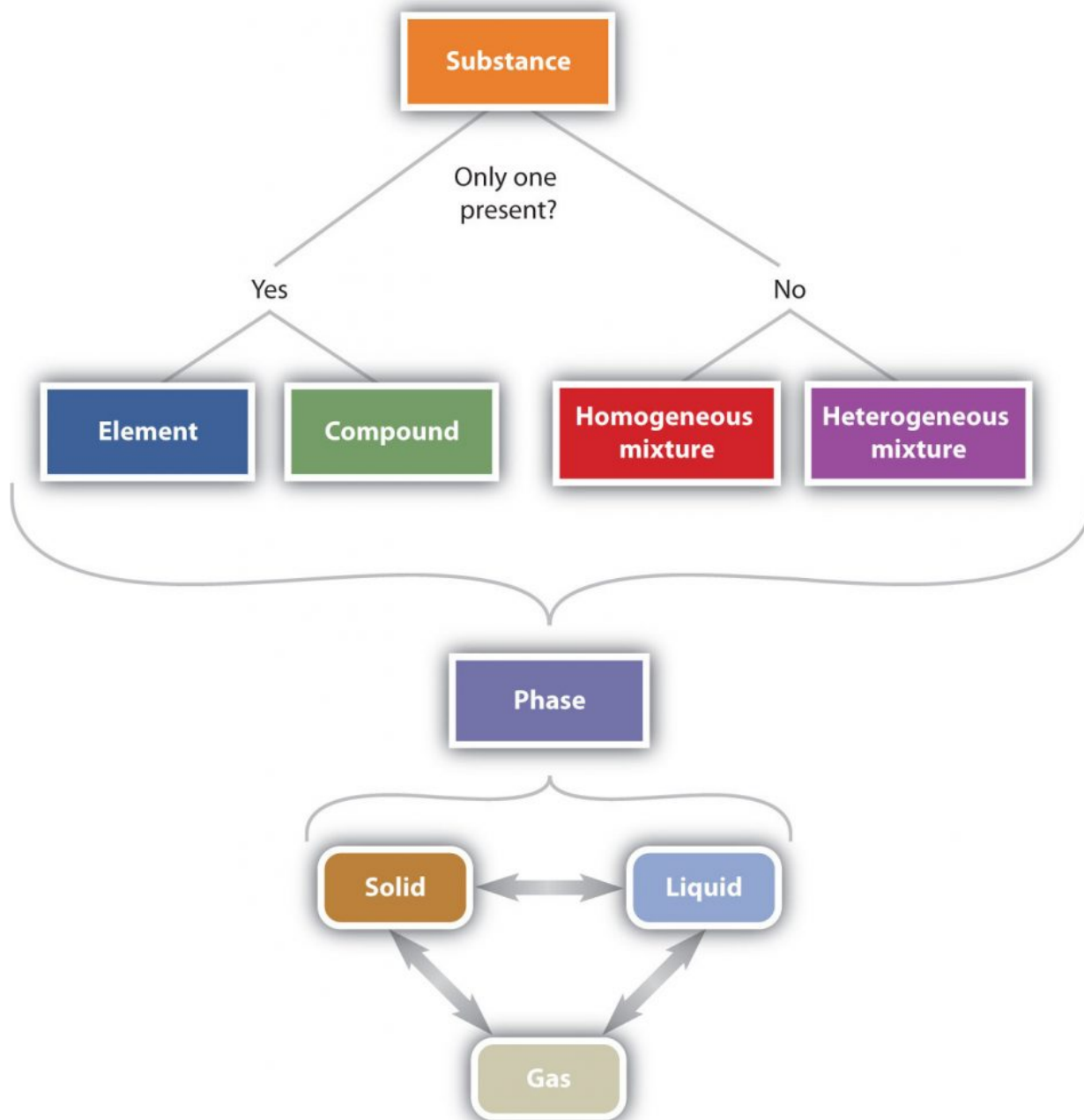

Figure 2.6 The Classification of Matter. Matter can be classified in a variety of ways depending on its properties

Reactions in Chemistry

Atoms can react chemically with one another to form new compounds and arrangements. When chemical reactions are written, they share some conventional features: (1) The reactants are written on the left hand side of the equation, (2) The products are written on the right hand side of the equation, (3) The reactants and products are separated by an arrow that shows the direction of the reaction, note that some reactions are reversible and are denoted by a double-headed arrow, (4) Conditions that are required for the reaction, such as heat or a catalyst (an agent that speeds up the chemical reaction without being used up in the process) are typically indicated above the arrow of the reaction, and (5) the reactants and products can be fully written out, or they can be represented by their chemical structures or by their chemical abbreviations (which you will learn how to formulate in the following chapters).

Reactions are written out with the quantities of the reactants and products in mind as well. During a chemical reaction, matter can never be destroyed. Thus, the atoms that are present on the left hand side of the equation must also be on the right hand side of the equation. They can be rearranged or in different forms, but they must be present. This is known as the **law of conservation of matter**. To conform to this law, reactions are always written with the minimal amount of reactants required to make the minimal amount of products. An example of a chemical reaction is given below in Figure 2.7

To represent the amounts of atoms present within a chemical reactions, numbers are present as either coefficients or subscripts within the equation. When the number is represented as a subscript, this indicates how many atoms of that element are required to make up a single molecule of the compound. In Figure 2.7, the chemical formula for carbon dioxide is given as CO_2 . The number 2 subscript next to the oxygen atom indicates that there are two atoms of oxygen within a single molecule of carbon dioxide. When there is no subscript present, this means that there is only one atom present. Thus, for one molecule of carbon dioxide, CO_2 , there is one atom of carbon and two atoms of oxygen. The coefficients in front of each substance, indicates how many molecules are required for a single reaction. In Figure 2.7, one molecule of methane reacts with 2 molecules of oxygen to yield one molecule of carbon dioxide and two molecules of water.

Since molecules are so small, it is impossible to ever measure out a single molecule when conducting an experiment in a laboratory. Thus, chemists will work with mole quantities of chemicals. The coefficients within chemical equations are also equivalent to mole quantities of each substance. Thus, the equation in Figure 2.7 can also be read as, one

mole of methane reacts with 2 moles of oxygen to yield one mole of carbon dioxide and two moles of water.

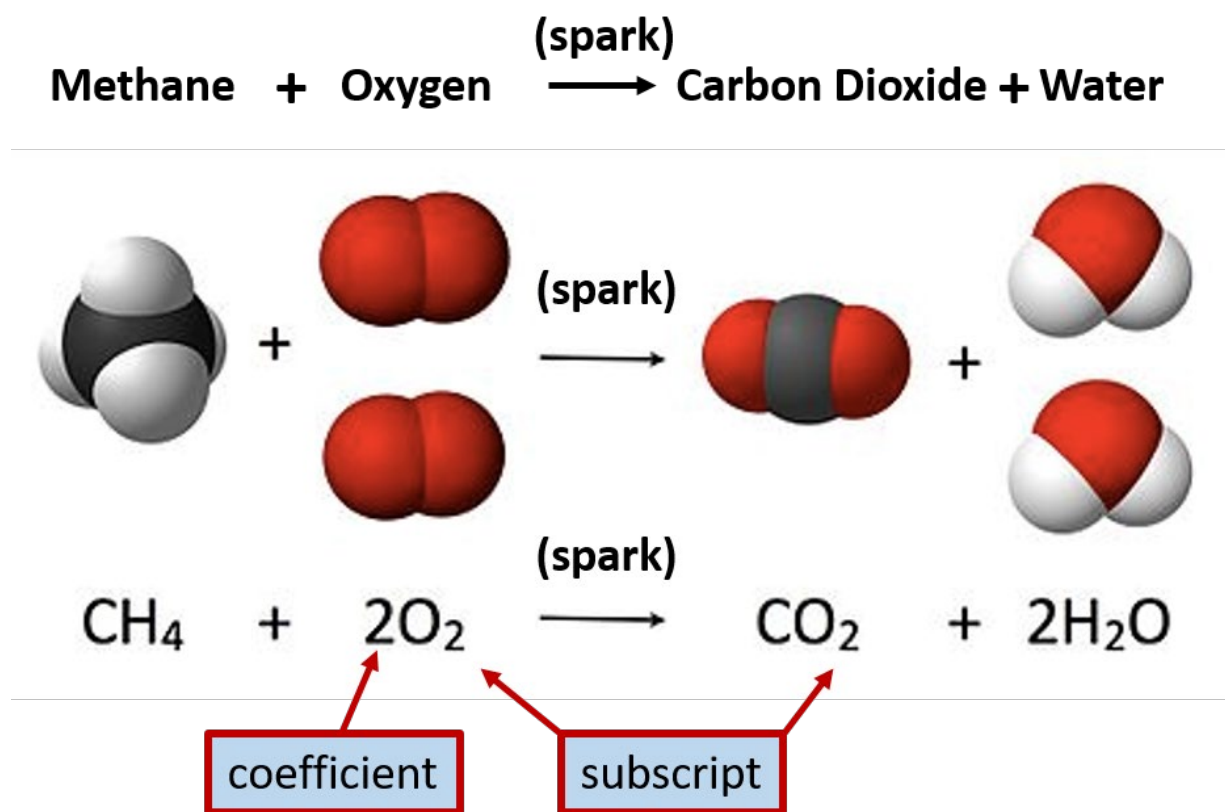

Figure 2.7 Representations of Chemical Reactions. In the example above the compound methane reacts with oxygen to form the products, carbon dioxide and water. Methane is also known as natural gas and is commonly burned to release usable energy. Subscripts present in the equation represent how many atoms of that element are involved with a chemical bond. If there is no number listed, the number one is implied. (ie in the carbon dioxide (CO₂) molecule denoted above, there is one atom of carbon (C) bonded with two atoms of oxygen (O) to form one molecule of carbon dioxide.) Note that to begin the burning process, a spark is needed to get the reaction started. This spark is noted over the arrow, as it is not a reactant or a product of the reaction.

This figure is adapted from [Jynto and Jynto \(2013\)](#).

Section 2.2: How Scientists Study Chemistry

The Scientific Method

How do scientists work? Generally, they follow a process called the **scientific method**. The scientific method is an organized procedure for learning answers to questions. To find the answer to a question (for example, “Why do birds fly toward Earth’s equator during the cold months?”), a scientist goes through the following steps, which are also illustrated in Figure 2.8.

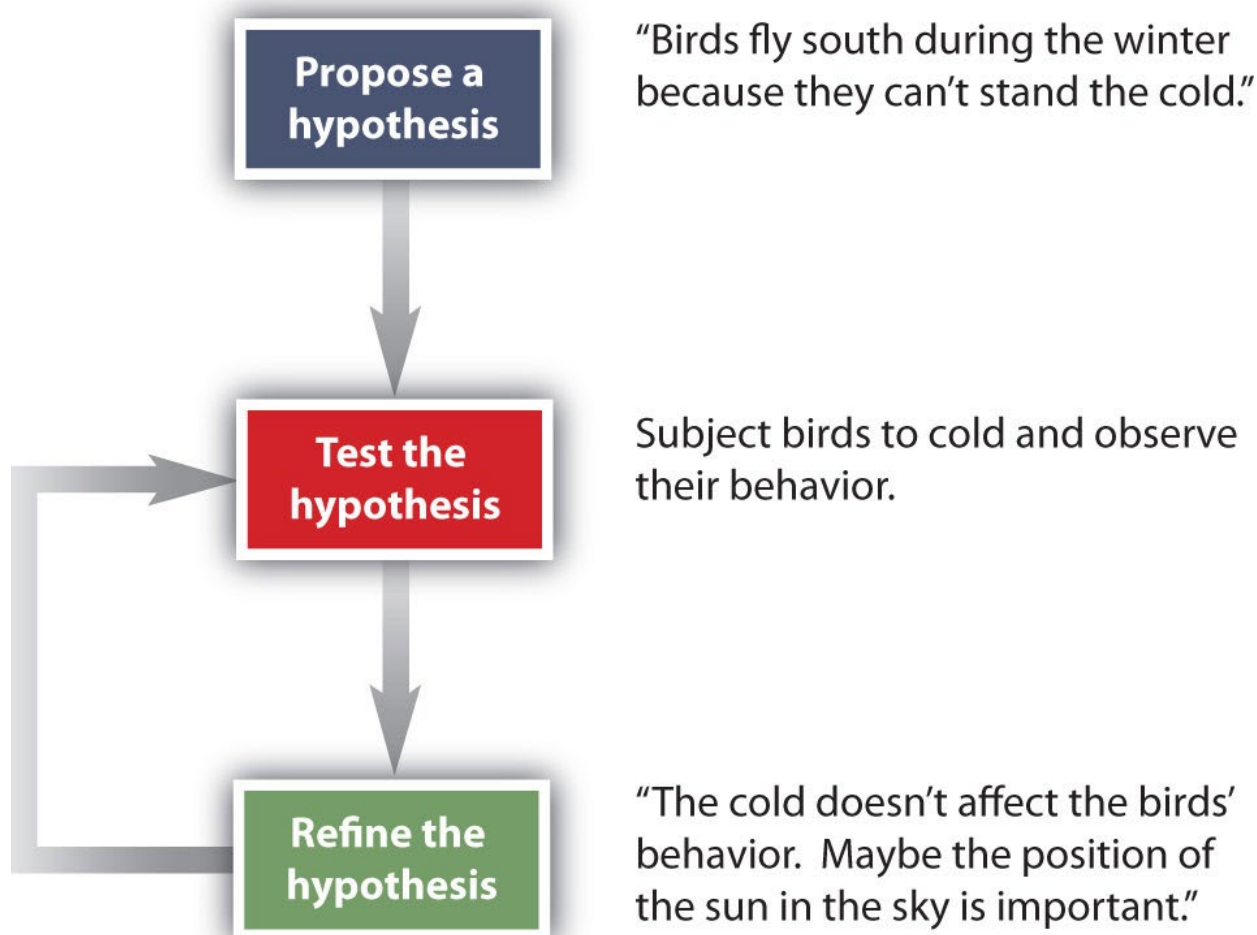

Figure 2.8 The General Steps of the Scientific Method. The steps may not be as clear-cut in real life as described here, but most scientific work follows this general outline.

Propose a hypothesis. A scientist generates a testable idea, or hypothesis, to try to answer a question or explain how the natural universe works. Some people use the word theory in place of hypothesis, but the word hypothesis is the proper word in science. For scientific applications, the word theory is a general statement that describes a large set of observations and data. A theory represents the highest level of scientific understanding, and is built from a wide array of factual knowledge or data.

Test the hypothesis. A scientist evaluates the hypothesis by devising and carrying out experiments to test it. If the hypothesis passes the test, it may be a proper answer to the question. If the hypothesis does not pass the test, it may not be a good answer.

Refine the hypothesis if necessary. Depending on the results of experiments, a scientist may want to modify the hypothesis and then test it again. Sometimes the results show the original hypothesis to be completely wrong, in which case a scientist will have to devise a new hypothesis.

Not all scientific investigations are simple enough to be separated into these three discrete steps. But these steps represent the general method by which scientists learn about our natural universe.

Concept Review Exercises

1. Define science and chemistry.
2. Define the scientific method.

Answers

1. Science is a process by which we learn about the natural universe by observing, testing and then generating models that explain our observations. Chemistry is the study of matter and how it behaves
2. The scientific method is the general process by which we learn about the natural universe.

Section 2.3: Atomic Theory with Historical Perspectives

What are the smallest building blocks of everyday objects? This is a question that has interested man since the age of the Greek philosophers. Like the ancient Greeks we can perform a simple thought experiment that raises a very important question for modern chemistry: suppose you were given a piece of aluminum foil and asked to cut the foil in half over and over. How long could you continue cutting, assuming that you had no limitations based on your own abilities? Is there a limit on how small matter can be broken up into, or could you infinitely divide matter into smaller and smaller pieces? This argument dates as far back as the Greek philosophers. Most, like Aristotle, argued that matter could be divided infinitely. However, one brilliant philosopher, Democritus, argued that there is a limit. He proposed that the smallest piece that any element (like aluminum) can be divided into and still be recognized as that element is an **Atom**, a word derived from the Greek word **atomos**, meaning “indivisible”.

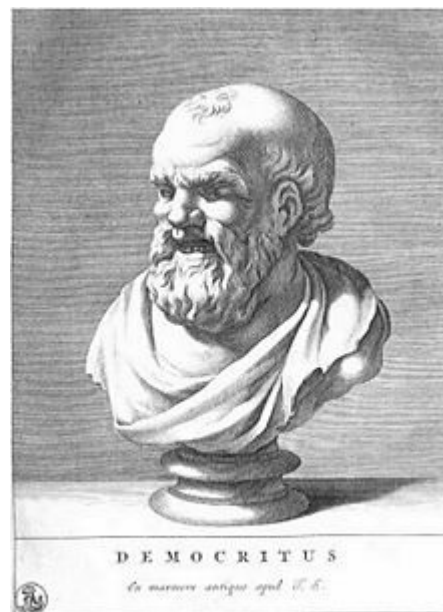

Figure 2.9: Democritus

Photo taken from: [Public Domain](#)

Philosophers, like Democritus (Figure 2.9), based most of their ideas off of thought experiments like the one above instead of actual observations and experimentation. It is for this reason that Democritus' ideas on atoms were dismissed until 1808, when John Dalton, an English scientist, proposed four fundamental assumptions based upon observations that we call **Dalton's Atomic Theory**.

Dalton proposed that:

- Matter is made up of tiny particles called atoms
 - Atoms cannot be broken into smaller pieces. During a chemical reaction, atoms are rearranged, but they do not break apart, nor are they created or destroyed
 - All atoms of the same element are identical in mass and other properties
 - Atoms of different elements differ in mass and other properties
-

Section 2.4 Introduction to Elements and the Periodic Table

An **element** is a substance that cannot be broken down into simpler chemical substances. There are about 90 naturally occurring elements known on Earth. Using technology, scientists have been able to create nearly 30 additional elements that are not readily found in nature. Today, chemistry recognizes a total of 118 elements which are all represented on a standard chart of the elements, called the Periodic Table of Elements (Figure 2.9). Each element is represented by a one or two letter code, where the first letter is always capitalized and, if a second letter is present, it is written in lowercase. For example, the symbol for Hydrogen is H, and the symbol for carbon is C. Some of the elements have seemingly strange letter codes, such as sodium which is Na. These letter codes are derived from latin terminology. For example, the symbol for sodium (Na) is derived from the latin word, natrium, which means sodium carbonate. Elements in the periodic table can be broken up into different general classes based upon similarities in their properties. Going from left to right across the periodic table, the elements can be broken up into metals, metalloids, and nonmetals.

Metals are typically shiny, very dense, and have high melting points. Most metals are ductile (can be drawn out into thin wires), malleable (can be hammered into thin sheets), and good conductors of both heat as well as electricity. All metals are solids at room temperature except for mercury. In chemical reactions, metals easily lose electrons to form positive ions. Examples of metals are silver, gold, and zinc.

Nonmetals are generally brittle, dull, have low melting points, and they are generally poor conductors of heat as well as electricity. In chemical reactions, they tend to gain electrons to form negative ions. Examples of nonmetals are hydrogen, carbon, and nitrogen.

Metalloids have properties of both metals and nonmetals. Metalloids can be shiny or dull. Electricity and heat can travel through metalloids, although not as easily as they can through metals. They are also called semimetals. They are typically semi-conductors, which means that they are elements that conduct electricity better than insulators, but not as well as conductors. They are valuable in the computer chip industry. Examples of metalloids are silicon and boron.

A.

Periodic Table of the Elements

Standard State at 25°C; 1 atm
 Ar - gas
 Br - Liquid
 Na - Solid

Relative Atomic Mass (A)
 Group IUPAC
 Atomic Number (Z)
 Element Symbol
 Element Name

Metals
 Semimetals
 Nonmetals
 Lanthanide/Actinide

Standard State at 25°C; 1 atm Ar - gas Br - Liquid Na - Solid																				
1	2											18								
1	IA	1.0079																2	VIIIA	4.0026
1	H	HYDROGEN																2	He	HELIUM
2	3	4											10							
2	Li	Be																10	Ne	
3	11	12											18							
3	Na	Mg																18	Ar	
4	19	20	21	22	23	24	25	26	27	28	29	30	31	32	33	34	35	36		
4	K	Ca	Sc	Ti	V	Cr	Mn	Fe	Co	Ni	Cu	Zn	Ga	Ge	As	Se	Br	Kr		
5	37	38	39	40	41	42	43	44	45	46	47	48	49	50	51	52	53	54		
5	Rb	Sr	Y	Zr	Nb	Mo	Tc	Ru	Rh	Pd	Ag	Cd	In	Sn	Sb	Te	I	Xe		
6	55	56	57-71	72	73	74	75	76	77	78	79	80	81	82	83	84	85	86		
6	Cs	Ba	La-Lu	Hf	Ta	W	Re	Os	Ir	Pt	Au	Hg	Tl	Pb	Bi	Po	At	Rn		
7	87	88	89-103	104	105	106	107	108	109	110	111	112	114							
7	Fr	Ra	Ac-Lr	Rf	Db	Sg	Bh	Hs	Mt	Ds	Rg	Cn	Fl							

Lanthanide Series	57	58	59	60	61	62	63	64	65	66	67	68	69	70	71
	La	Ce	Pr	Nd	Pm	Sm	Eu	Gd	Tb	Dy	Ho	Er	Tm	Yb	Lu
	LANTHANUM	CERIUM	PRASEODYMIUM	NEODYMIUM	PROMETHIUM	SAMARIUM	EUROPIUM	GADOLINIUM	TERBIUM	DYSPROSIUM	HOLMIUM	ERBIUM	THULIUM	Ytterbium	LUTETIUM

Actinide Series	89	90	91	92	93	94	95	96	97	98	99	100	101	102	103
	Ac	Th	Pa	U	Np	Pu	Am	Cm	Bk	Cf	Es	Fm	Md	No	Lr
	ACTINIUM	THORIUM	PROTACTINIUM	URANIUM	NEPTUNIUM	PLUTONIUM	AMERICIUM	CURIUM	BERKELIUM	CALIFORNIUM	EINSTEINIUM	FERMIUM	MENDELEVIUM	NOBELIUM	LAWRENCIUM

[Periodic Table Downloadable PDF Version](#)

Figure 2.10A: Periodic Table of the Elements. All of the known chemical elements are arranged in the format of a table. The table has been set up in such a way that the characteristics of each different element can be predicted by their position on the table. (A) On this rendition of the periodic table, you can see that the pink elements on the left-hand side of the table are the metals, while the blue elements on the right are the nonmetals (Hydrogen is the only exception to this rule and will be explained in the subsequent sections). The metalloids (also termed semi-metals) occur in a staircase pattern between the metals and nonmetals and are represented in this diagram by the green elements.

B.

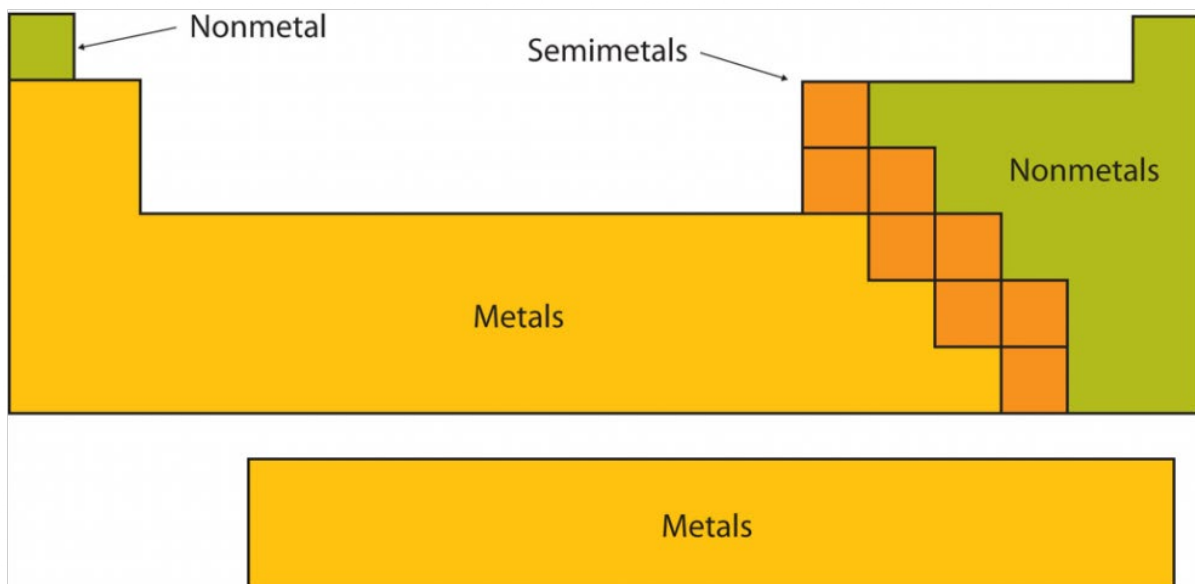

Figure 2.10B: Periodic Table of the Elements. (B) Shows the positions of the metals, nonmetals and metalloids on the periodic table. During this chapter, you will learn more about these unique characteristics, called periodic trends.

The elements vary widely in abundance. In the universe as a whole, the most common element is hydrogen (about 90%), followed by helium (most of the remaining 10%). All other elements are present in relatively minuscule amounts, as far as we can detect. On the planet Earth, however, the situation is rather different. Oxygen makes up 46.1% of the mass of Earth's crust (the relatively thin layer of rock forming Earth's surface), mostly in combination with other elements, while silicon makes up 28.5%. Hydrogen, the most abundant element in the universe, makes up only 0.14% of Earth's crust. Table 1.2 lists the relative abundances of elements on Earth as a whole and in Earth's crust. Table 1.3 lists the relative abundances of elements in the human body. If you compare Table 1.2 and 1.3, you will find disparities between the percentage of each element in the human body and on Earth. Oxygen has the highest percentage in both cases, but carbon, the element with the second highest percentage in the body, is relatively rare on Earth and does not even appear as a separate entry in Table 2.2; carbon is part of the 0.174% representing "other" elements. How does the human body concentrate so many apparently rare elements?

The relative amounts of elements in the body have less to do with their abundances on Earth than with their availability in a form we can assimilate. We obtain oxygen from the air we breathe and the water we drink. We also obtain hydrogen from water. On the other hand, although carbon is present in the atmosphere as carbon dioxide, and about 80% of the atmosphere is nitrogen, we obtain those two elements from the food we eat, not the air we breathe.

Table 2.2 Elemental Composition of the Earth

Earth's Crust		Earth (Overall)	
Element	Percentage	Element	Percentage
Oxygen	46.1	Iron	34.6
Silicon	28.2	Oxygen	29.5
Aluminium	8.23	Silicon	15.2
Iron	5.53	Magnesium	12.7
Calcium	4.15	Nickel	2.4
Sodium	2.36	Sulfur	1.9
Magnesium	2.33	all others	3.7
Potassium	2.09		
Titanium	0.565		
Hydrogen	0.14		
Phosphorous	0.105		
All others	0.174		

Table 2.3 Elemental Composition of the Human Body

Human Body		Human Body Cont.	
Element	Percent By Mass	Element	Percent By Mass
Oxygen	61	Sodium	0.14
Carbon	23	Chlorine	0.12
Hydrogen	10	Magnesium	0.027
Nitrogen	2.6	Silicon	0.026
Calcium	1.4	Iron	0.006
Phosphorous	1.1	Flourine	0.0037
Sulfur	0.20	Zinc	0.003
Potassium	0.20	All Others	0.174

Source of Tables 1.2 and 1.3: D.R. Lide, ed. CRC Handbook of Chemistry and Physics 89th ed. (Boca Raton, FL: CRC Press, 2008-9), 7-24.

[\(Back to the Top\)](#)

Section 2.5 Dmitri Mendeleev and The Periodic Table

In the 19th century, many previously unknown elements were discovered, and scientists noted that certain sets of elements had similar chemical properties. For example, chlorine, bromine, and iodine react with other elements (such as sodium) to make similar compounds. Likewise, lithium, sodium, and potassium react with other elements (such as oxygen) to make similar compounds. Why is this so?

In 1864, Julius Lothar Meyer, a German chemist, organized the elements by atomic mass and grouped them according to their chemical properties. Later that decade, Dmitri Mendeleev, a Russian chemist, organized all the known elements according to similar properties. He left gaps in his table for what he thought were undiscovered elements, and he made some bold predictions regarding the properties of those undiscovered elements. Later, when elements were discovered whose properties closely matched Mendeleev's

predictions, his version of the table gained favor in the scientific community. Because certain properties of the elements repeat on a regular basis throughout the table (that is, they are periodic), it became known as the **periodic table (Figure 2.11)**.

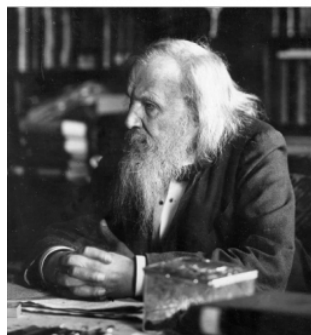

Dmitri Mendeleev

Reihen	Gruppe I. — R ⁰	Gruppe II. — R ⁰	Gruppe III. — R ⁰	Gruppe IV. RH ⁴ R ⁰	Gruppe V. RH ³ R ⁰	Gruppe VI. RH ² R ⁰	Gruppe VII. RH R ⁰	Gruppe VIII. — R ⁰
1	H=1							
2	Li=7	Be=9,4	B=11	C=12	N=14	O=16	F=19	
3	Na=23	Mg=24	Al=27,3	Si=28	P=31	S=32	Cl=35,5	
4	K=39	Ca=40	—=44	Ti=48	V=51	Cr=52	Mn=55	Fe=56, Co=59, Ni=59, Cu=63.
5	(Ca=63)	Zn=65	—=68	—=72	As=75	So=78	Br=80	
6	Rb=86	Sr=87	?Yt=88	Zr=90	Nb=94	Mo=96	—=100	Ru=104, Rh=104, Pd=106, Ag=108.
7	(Ag=108)	Cd=112	In=113	Sa=118	Sb=122	Te=125	J=127	
8	Cs=133	Ba=137	?Di=138	?Co=140	—	—	—	— — — —
9	(—)	—	—	—	—	—	—	
10	—	—	?Er=178	?La=180	Ta=182	W=184	—	Os=195, Ir=197, Pt=198, Au=199.
11	(Au=199)	Hg=200	Tl=204	Pb=207	Bi=208	—	—	
12	—	—	—	Th=231	—	U=240	—	— — — —

Figure 2.11: Dmitri Medeleev's 1871 Early Version of the Periodic Table

Photo of Dmitri Medeleev provided by: [кабинет академика Михаила Михайловича Шульца - фото любезно передано мне в собственность вдовой М.М.Шульца Ниной Дмитриевной Шульц](#)

Periodic Table provided by: [Den fjättrade ankan](#)

Section 2.6 Families of the Periodic Table

Remember that Mendeleev arranged the periodic table so that elements with the most similar properties were placed in the same group. A group, or **family of elements**, is a vertical column of the periodic table. Elements are placed into families due to their similar properties, characteristics, and reactivity. For example, all of the elements in group 1 (except for hydrogen, which has unique properties) are very reactive and form compounds in the same ratios and with similar properties as other 1 elements. Due to the similarities in their chemical properties, Mendeleev put these elements into the same group and they came to be known as the **alkali metals**. The alkali metals include: lithium, sodium, potassium, rubidium, cesium, and francium. Alkali metals are among the most reactive metals. This is due in part to their larger atomic radii and low ionization energies, that will be discussed in more details in section 2.8 below. They get their name from ancient Arabic (al qali) because "scientists" of the time found that the ashes of the vegetation they were burning contained a large amount of sodium and potassium. In Arabic, *al qali* means *ashes*. Although most metals tend to be very hard, alkali metals have a soft texture, are

silvery in color and can be easily cut. They also have low boiling and melting points and are less dense than most elements. Figure 2.12 shows some of the most common families on the periodic table.

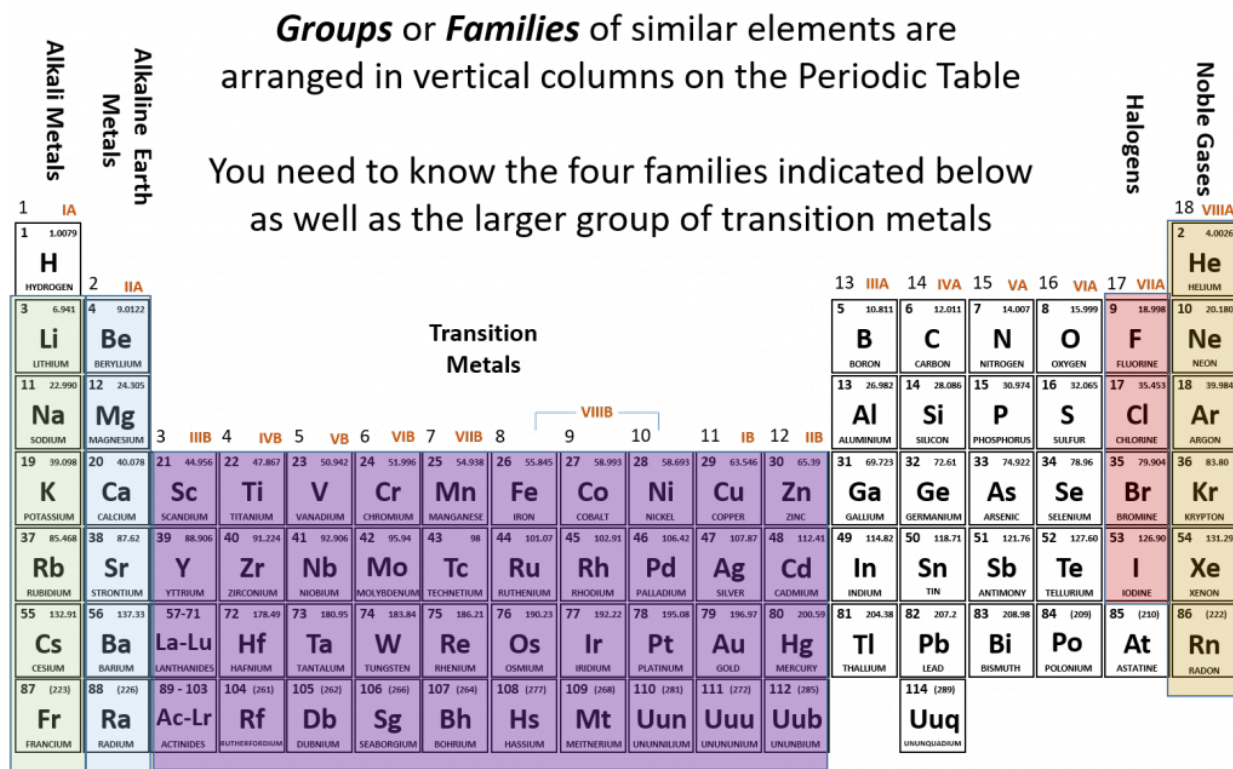

Figure 2.12 Common Families and Groups of the Periodic Table.

The same pattern is true of other vertical groups on the periodic table. Group 2 is called the **alkaline earth metals**. Once again these elements have similar properties to each other. Alkaline earth metals include Beryllium, Magnesium, Calcium, Barium, Strontium and Radium and are soft, silver metals that are less metallic in character than the Group 1 alkali metals. Although many characteristics are common throughout the group, the heavier metals such as Ca, Sr, Ba, and Ra are almost as reactive as the Group 1 alkali metals. They get their name because early "scientists" found that all of the alkaline earth metals were found in the earth's crust.

The transition metals are the larger block of elements shown in purple on Figure 2.12 extending from Groups 3-12 (also known as the group B elements). Transition elements differ from the main group elements (group A elements) in that they tend to be hard and have high densities. They have high melting points and boiling points and can show

various oxidation states when forming chemical bonds (this will be discussed further in chapter 3). They often form colored compounds that are highly stable and they can serve as good catalysts. A catalyst is an agent that helps to speed up a chemical reaction without itself being changed in the process.

Group 17 elements are also called **halogens**. This group contains very reactive nonmetals. The halogens are an interesting group. Halogens are members of Group 17, which is also referred to as 7A. It is the only group in the Periodic Table that contains all of the states of matter at room temperature. Fluorine, F_2 and chlorine, Cl_2 are gases, while Bromine, Br_2 , is a liquid and iodine, I_2 , and astatine, At_2 , are both solids. Another interesting feature about Group 17 is that it houses four (4) of the seven (7) diatomic elements. Diatomic elements only exist in nature as a pair of atoms of the same element that are bonded together. The seven diatomic elements are H_2 , N_2 , O_2 , F_2 , Cl_2 , Br_2 , and I_2 . Notice that the latter four are Group 17 elements. The word halogen comes from the Greek meaning *salt forming*. French chemists discovered that the majority of halogen ions will form salts when combined with metals.

The **noble gases** are in group 18. The two most significant properties of noble gases is that they are extremely unreactive, rarely forming compounds, and that they all exist as gases at room temperature. We will learn the reason for their unreactivity when we discuss how compounds form in chapters 3 and 4. The first person to isolate a noble gas was Henry Cavendish, who isolated argon in the late 1700s. The noble gases were actually considered inert gases until the 1960s when a compound was formed between xenon and fluorine which changed the way chemists viewed the "inert" gases. In the English language, inert means to be lifeless or motionless; in the chemical world, inert means *does not react*. Later, the name "**noble gas**" replaced "inert gas" for the name of Group 18. The elements in this group are also gases at room temperature.

Section 2.7 Defining the Atom

Basic Atomic Structure – electrons, neutrons, and protons

The modern atomic theory, proposed about 1803 by the English chemist John Dalton, is a fundamental concept that states that all elements are composed of atoms. An atom is the smallest part of an element that maintains the identity of that element. Individual atoms are extremely small; even the largest atom has an approximate diameter of only

5.4×10^{-10} m. With that size, it takes over 18 million of these atoms, lined up side by side, to equal the width of your little finger (about 1 cm).

Most elements in their pure form exist as individual atoms. For example, a macroscopic chunk of iron metal is composed, microscopically, of individual iron atoms. Some elements, however, exist as groups of atoms called molecules. Several important elements exist as two-atom combinations and are called diatomic molecules. In representing a diatomic molecule, we use the symbol of the element and include the subscript 2 to indicate that two atoms of that element are joined together. The elements that exist as diatomic molecules are hydrogen (H_2), oxygen (O_2), nitrogen (N_2), fluorine (F_2), chlorine (Cl_2), bromine (Br_2), and iodine (I_2).

Atoms are made up of extremely small subatomic particles called protons, neutrons, and electrons. **Protons** are positively charged particles with a relative mass of 1.672622×10^{-24} g, which form part of the core **nucleus** of an atom. The other part of the atomic nucleus is made up of neutrons, electrically neutral particles with a relative mass almost identical to a proton (1.674927×10^{-24} g). **Electrons** are extremely small (9.109328×10^{-28} g) negatively charged particles that form an electron cloud, which orbits the nucleus. Table 2.4 summarizes some of the general properties of subatomic particles.

Table 2.4 Properties of Subatomic Particles

Particle	Symbol	Mass (kg)	Relative Mass (proton =1)	Relative Charge
Proton	p^+	1.673×10^{-27}	1	+1
Neutron	n^0	1.675×10^{-27}	1	0
Electron	e^-	9.109×10^{-31}	0.00055	-1

Experiment have shown that protons and neutrons are concentrated in a central region of each atom called the nucleus (plural, nuclei). Electrons are outside the nucleus and orbit about it because they are attracted to the positive charge in the nucleus. Figures 2.13 and 2.14 depict the structure of an atom.

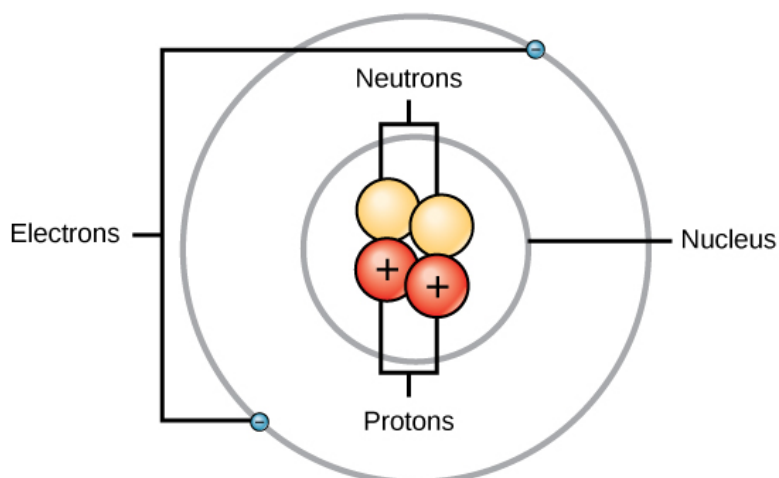

Figure 2.13 The Anatomy of an Atom. The protons and neutrons of an atom are found clustered at the center of the atom in a structure called the nucleus. The electrons orbit the nucleus of the atom within an electron cloud, or the empty space that surrounds the atom's nucleus. Note that most of the area of an atom is taken up by the empty space of the electron cloud. Diagram provided by: [CNX OpenStax](#)

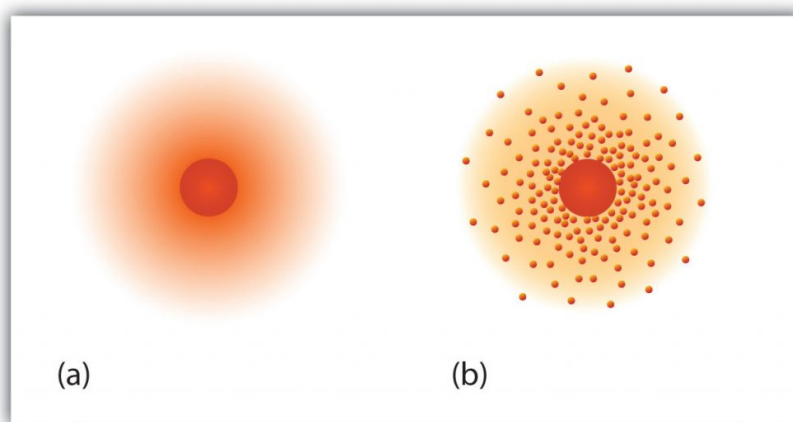

Fig 2.14 The path of the electron in a hydrogen atom. Electrons are not in discrete orbits like planets around the sun. Instead there is a probability that an electron may occupy a certain space within the electron cloud (a) The darker the color, the higher the probability that the hydrogen's one electron will be at that point at any given time. (b) Similarly, the more crowded the dots, the higher the probability that hydrogen's one electron will be at that point. In both diagrams, the nucleus is in the center of the diagram.

The electrons within an atom are arranged within specific energy shells. These shells can also be thought of as electron clouds, as the electrons are in constant motion around the nucleus of the atom. Notably each period on the periodic table (ie rows n1-n7) represents the number of electron shells present in the elements within that period. For example, Aluminum is in the 3rd row of the periodic table and, thus, contains a total of 3 electron shells. Shells that are positioned more closely to the nucleus are of lower energy than shells that are farther away (ie shell n1 is the closest to the nuclei and will have the lowest energy levels). Within each shell the electrons are further divided into subshells and then orbitals within each subshell. With regards to chemical bonding, the most important electrons within the atom are known as the **valence electrons**. The **valence electrons** are the electrons that are located at the outermost edge of the atom. For almost all of the elements on the periodic table, the maximum number of valence electrons within an atom is eight. This is known as **the octet rule**. In Chapter 4, we will begin to see how valence electrons within atoms are involved in chemical bonding.

Interestingly, most of the mass of an atom is housed in the nucleus of the atom, held in the protons and the neutrons. However, the size of the nucleus is very, very tiny in relation to the entire atom. Most of the space within an atom is made up of the electron cloud. For example, if an atom was the size of a soccer stadium, the nucleus would be about the size of a small marble at the center of the stadium. The rest of the stadium would represent the empty space of the electron cloud. As a result, an atom consists largely of empty space.

Atomic particles are so small that it is impractical to measure them in grams, instead we use a relative mass scale which makes the numbers much more manageable. We use **Atomic Mass Units (AMU or u)** to measure the mass of atomic particles, one AMU is equal to 1/12th the mass of an atom of carbon-12. You may also see Atomic Mass Units referred to as **Daltons (Da)** after John Dalton, the English Chemist that first proposed the atomic theory. Carbon-12 has 6 protons and 6 neutrons in its nucleus, meaning that one amu is equal to the average of the masses of a proton and a neutron. The mass of an atom in AMUs is equal to the number of protons and neutrons making up the atom. For example the atomic mass of bromine is roughly 80 amu and its proton number is 35, meaning that bromine has 35 protons and 45 neutrons in its nucleus.

Section 2.8 Atomic Number - Protons Determine the Identity of an Element

When looking at the periodic table you might notice that for each element there are two sets of numbers around the symbol. These symbols correspond to important values that give you important information about each element (Figure 2.15). The most important value corresponding to characteristics of an element is the proton number, which is also called **atomic number** (represented by the mathematical term, **Z**). As it turns out, the number of protons that an atom holds in its nucleus is the key determining feature for its chemical properties. In short, an element is defined by the number of protons found in its nucleus. If you refer back to the Periodic Table of Elements shown in figure 2.10, you will see that the periodic table is organized by the number of protons that an element contains. Thus, as you read across each row of the Periodic Table (left to right), each element increases by one proton (or one Atomic Number, **Z**).

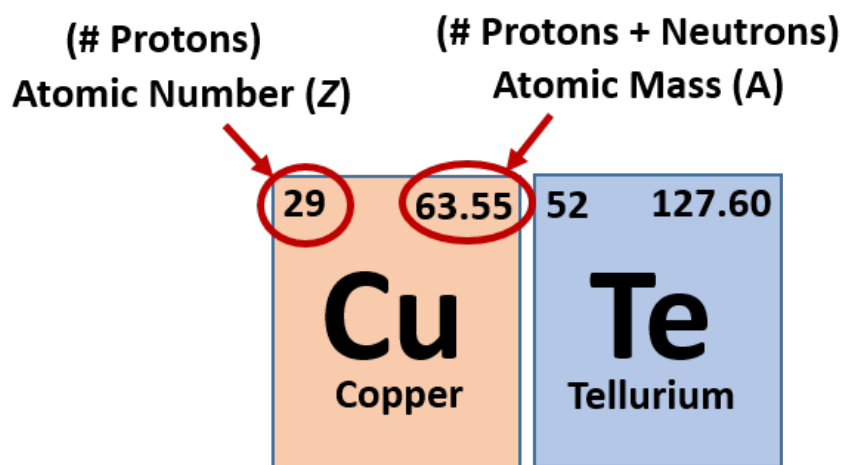

Fig 2.15 Structure of the Periodic Table. Each element on the periodic table is represented by the atomic symbol (Cu for Copper, and Te for Tellurium). Sometimes the Atomic Number is written in the upper lefthand corner, and the Atomic Mass in the righthand corner, as shown in this figure. Sometimes, periodic tables will show the atomic number above the element symbol and the atomic mass below the element symbol, as shown in the periodic table in Figure 2.10.

When atoms are in their elemental states, their overall charge is zero and the atoms are neutral. Since protons are positively charged and electrons are negatively charged, this means that when atoms are in their elemental form, the number of protons equals the

number of electrons. Therefore, if you know the atomic number of an atom, you also know how many electrons are present in that atom when it is in its elemental form. When atoms combine with one another to form compounds, like water (H₂O), they will either share or donate/accept electrons from their bonding partners. It is this movement of electrons that facilitates chemical bond formation. Thus, during bond formation the number of electrons around an atom may change, but the atomic number (or number of protons) remains constant and does not change.

Section 2.9 Atomic Mass, Isotopes, and Molar Mass

Atomic Mass

Atomic mass (A) is the total mass of an atom of a specific element and can be calculated by adding up the number of protons and neutrons present within an atom. The electrons are ignored in the mass calculation because they are so small that they barely add any mass to the atom.

$$\# \text{ Protons} + \# \text{ Neutrons} = \text{Atomic Mass}$$

Thus, if you know any two of the the three values (atomic mass, atomic number, or number of neutrons), you can calculate the third value. For example, nitrogen has an atomic mass of 14.007 and an atomic number of 7. Thus, it contains 7 protons, and 7 neutrons ($14.007 - 7 = 7.007$, which is then rounded to 7). Note that the number of neutrons in an atom does not have to equal the number of protons in the atom. For example, lead (Pb), contains 82 protons and has an atomic mass of 207.2. Thus it contains 125 neutrons ($207.2 - 82 = 125$). Thus, if you know the atomic mass and the atomic number of an element, you can calculate the number of neutrons present, or if you know the atomic mass and the number of neutrons, you can calculate the atomic number.

Isotopes

So...how many neutrons are in atoms of a particular element? At first it was thought that the number of neutrons in a nucleus was also defining characteristic of an element. However, it was found that atoms of the same element can have different numbers of neutrons. Atoms of the same element that have different numbers of neutrons are called **isotopes**. An example of the three common isotopes of hydrogen are shown in Figure 2.16. Note that each of the hydrogen isotopes is known by a unique name, hydrogen, deuterium, and tritium. Not all elemental isotopes have such unique names. Many of the

isotopes are distinguished from one another by including the atomic mass in the definition. For example, 99% of the carbon atoms on Earth have 6 neutrons and 6 protons in their nuclei, this is known as carbon-12; just under 1% of the carbon atoms have 7 neutrons and 6 protons in their nuclei, which is known as carbon-13, and an even smaller percent is carbon with 8 neutrons and 6 protons, or carbon-14. Carbon-14 is unstable and will decay over time making it a **radioactive form** of carbon. The characterization of radioactive materials will be covered in more detail in Chapter 3. Overall, there are 15 known isotopes of carbon! Thus, naturally occurring carbon on Earth, therefore, is actually a mixture of isotopes, albeit a mixture that is 99% carbon-12. Isotope composition has proven to be a useful method for dating many rock layers and fossils.

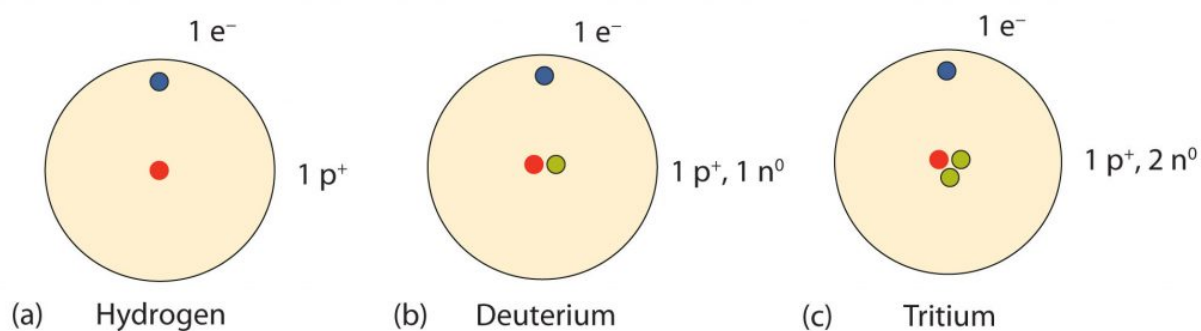
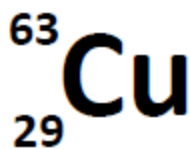

Fig 2.16 Isotopes of Hydrogen. All hydrogen atoms have one proton and one electron. However, they can differ in the number of neutrons. (a) Most hydrogen atoms only contain one proton and one electron and no neutrons (b) A small amount of hydrogen exists as the isotope deuterium, which has one proton and one neutron in its nucleus, and (c) an even smaller amount contains one proton and two neutrons in its nucleus and is termed Tritium. Note that Tritium is unstable isotope and will breakdown over time. Thus, Tritium is a radioactive element.

Most elements exist as mixtures of isotopes. In fact, there are currently over 3,500 isotopes known for all the elements. When scientists discuss individual isotopes, they need an efficient way to specify the number of neutrons in any particular nucleus. A simple way of indicating the mass number of a particular isotope is to list it as a superscript on the left side of an element's symbol. Atomic numbers are often listed as a subscript on the left side of an element's symbol. Thus, we might see



which indicates a particular isotope of copper. The 29 is the atomic number, **Z**, (which is the same for all copper atoms), while the 63 is the atomic mass (A) of the isotope. To determine the number of neutrons in this isotope, we subtract 29 from 63: $63 - 29 = 34$, so there are 34 neutrons in this atom.

The atomic masses indicated on the periodic table represents an average mass for each element based on the proportion of each isotope present on the Earth. This is why most of the atomic masses on the periodic table are not exact numbers. For example, the atomic mass of copper is 63.546 amu. This mass is an average of an element's atomic masses, weighted by the natural abundance of each isotope. So how could we calculate atomic mass based on the natural abundance of different isotopes of an element?

Example: Calculating Atomic Mass Using Isotope Abundance

Copper has two stable isotopes: ${}^{63}\text{Cu}$ (A = 62.93 Da) and ${}^{65}\text{Cu}$ (A = 64.93 Da). On Earth, the abundance of ${}^{63}\text{Cu}$ is 69.15%, whereas the abundance of ${}^{65}\text{Cu}$ is 30.85%. From this data, we can calculate the average atomic mass for Cu. Note that the Atomic Mass values on the periodic table, represent the average relative abundance of the isotopes found on the Earth.

$$(62.93 \text{ Da}) \left[\frac{69.15}{100} \right] + (64.93 \text{ Da}) \left[\frac{30.85}{100} \right] = 63.55 \text{ Da}$$

Extra Practice:

Try to work out the atomic mass for boron. Boron exists as a mixture that is 19.9% ${}^{10}\text{B}$ and 80.1% ${}^{11}\text{B}$. Calculate the atomic mass. Check the periodic table for the correct answer!

Molar Mass

In Chapter 1, you learned that 1 mole of any substance is equivalent to 6.02×10^{23} molecules of that substance. But why this number? It seems like a strange number for chemists to work with! However, it turns out that this number of items of any atom or any substance is proportional to the atomic mass of that substance in grams, and this is very useful indeed! Atoms and molecules are way too small to count on an individual scale. However, when you are setting up a chemical reaction in the laboratory, reactions are written such that you know how many of each reactant will react with the other reactant to give you a known number of product molecules. It would be very expensive and wasteful indeed, if we did not have some way to determine how many molecules that we are adding of each substance when we are conducting a chemical reaction. Thus, the relationship of Avogadro's Number to the Molar Mass of a substance provides us with a mechanism to convert the number of molecules present into their gram mass. It is easily possible for us to measure out gram quantities of substances in the laboratory using a simple balance. Thus, by using the relationship of Avogadro's Number with the Molar Mass, we are able to conduct very precise measurements of the substances used in chemical reactions, saving both time and money!

So how does it work? We just learned in the section above that the atomic mass of each element is given on the periodic table, and is determined by the number of protons and neutrons present in the atom. For example the atomic mass of Sodium (Na) is 22.990 Daltons or Atomic Mass Units. If we were to relate this mass to the mass of 1 mole of Na atoms, the mass would be 22.990 grams. This would mean that 6.02×10^{23} atoms of Sodium has a mass of 22.990 g! Similarly, for any substance, such as water (H_2O), we need only to add the atomic masses of each element in the substance together to obtain the molar mass of that substance. For water, there are 2 Hydrogens and 1 Oxygen atom. Adding the atomic masses of these elements together, we would get $2(1.0079) + 15.999 = 18.0148$ atomic mass units. This is then equivalent to the molar mass of water which is 18.0148 g of water = 1 mole of water = 6.02×10^{23} molecules of water. Thus, the overall definition of molar mass is that the molar mass of a substance is equal to the atomic mass of that substance in grams and is equivalent to 6.02×10^{23} molecules of that substance.

A little practice:

What is the molar mass of glucose ($C_6H_{12}O_6$)?

What is the molar mass of Sodium Hydrogen Carbonate ($NaHCO_3$)?

How many moles is 42.3 grams of Magnesium (Mg)?

How many atoms are in 63 grams of Mercury (Hg)?

Section 2.10 Periodic Table Trends

Now that you have learned some basic concepts about atomic structure and the organization of elements on the periodic table, we can use that knowledge to discuss some common periodic trends.

Atomic Size

One important trend to be aware of is the way that **atomic size** changes as you move across a period or down a group in the periodic table. **Atomic size** is typically measured by the radius of the atom starting at the core of the nucleus, and reaching all the way out to the last valence electron. As you may predict, atomic size will increase as you move down a family group, due to the increased number of electron shells. This substantially increases the size of the electron cloud. What you may not so easily predict is that atomic size decreases as you go across a period. Although this may seem counter-intuitive, the decrease in size can be explained by thinking about the valence electron shell as you go across a period; we see that each element across a period has the same valence electron shell that it is filling with valence electrons. While the valence shell stays the same as you go across a period, the number of protons and electrons is increasing. Protons, being positively charged, have a pull on the negatively charged electrons out in the electron cloud. As the number of protons and electrons increases across a period, they have an attractive pull on one another. This results in a tightening of the electron cloud and a reduction in the atomic nuclei. In other words, because the outermost electron shell remains the same across a period, that shell gets pulled progressively closer and closer to the nucleus of the atom as you go across a period. So the overall periodic trend for atomic radius (size) is that atoms get smaller as you go across a period, and they get larger as you go down a family group (Figure 2.16).

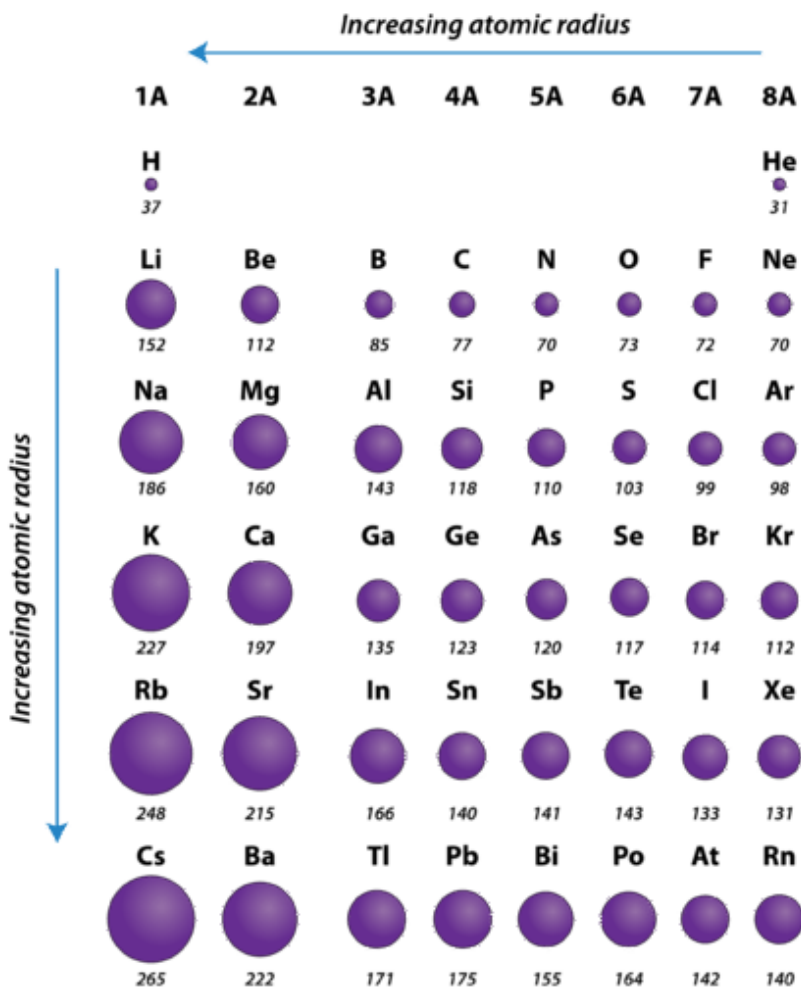

Figure 2.17 Atomic Radii of Select Elements Across the Periodic Table

Overall:

Atomic radius is determined as half the distance between the nuclei of two identical atoms bonded together.

The atomic radius of atoms generally decreases from left to right across a period.

The atomic radius of atoms generally increases from top to bottom within a group.

Electronegativity

Another important periodic trend to be aware of is how **electronegativity** differences can be identified. **Electronegativity** is the measure of an atom's tendency to attract a bonding

pair of electrons. There are various numerical scales for rating electronegativity. Figure 2.18 shows one of the most popular—the **Pauling scale**. The Pauling scale assigns fluorine, the most electronegative atom, a 4.0 while less electronegative atoms have smaller grades. We will see in chapters 3 and 4 that electronegativity plays an important role in chemical bonding. The trends for electronegativity in the periodic table are that electronegativity increases as you go across a period, and increases as you go up a group, with fluorine being the most electronegative atom. Noble gases are given an electronegativity rating of 0 due to their inherent stability, which keeps them from forming bonds with other atoms.

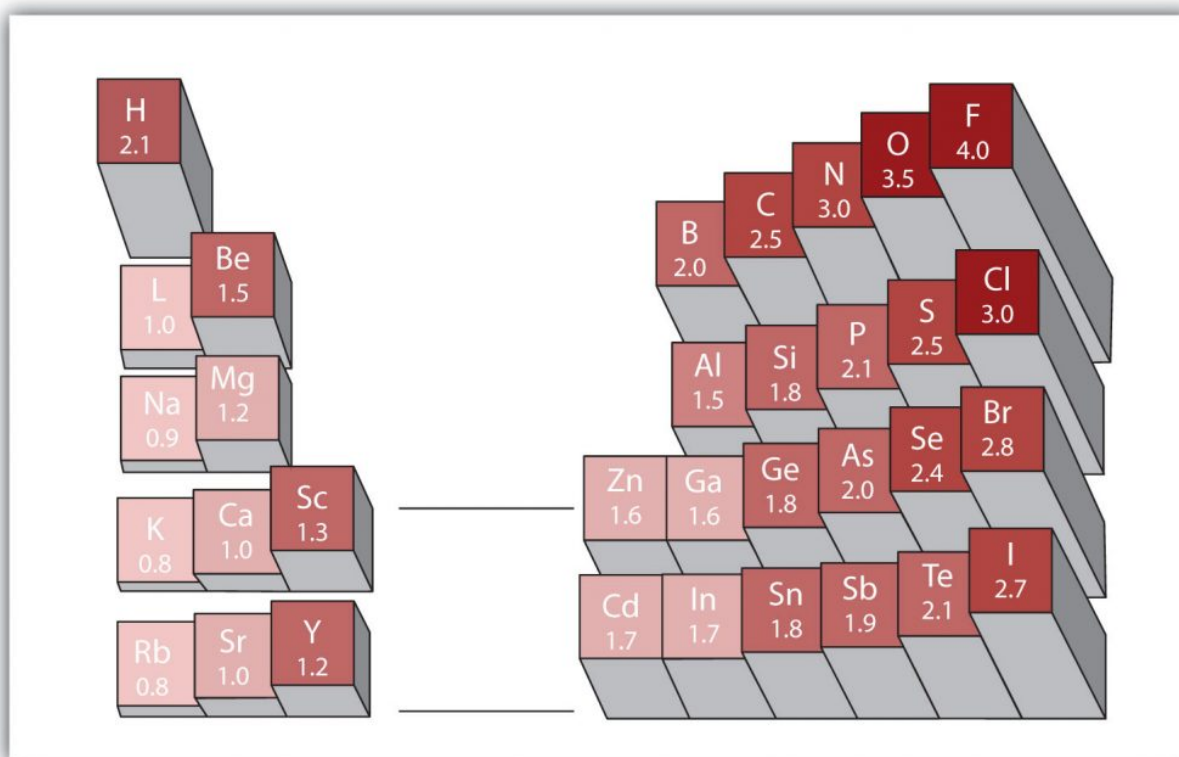

Figure 2.18 Electronegativities of Various Elements. The Pauling Scale for electronegativities has the value for fluorine atoms set at 4.0, the highest value.

Linus Pauling – A Closer Look

Arguably the most influential chemist of the 20th century, Linus Pauling (1901–94) is the only person to have won two individual (that is, unshared) Nobel Prizes. In the 1930s, Pauling used new mathematical theories to enunciate some fundamental principles of the chemical bond. His 1939 book *The Nature of the Chemical Bond* is one of the most significant books ever published in chemistry.

By 1935, Pauling's interest turned to biological molecules, and he was awarded the 1954 Nobel Prize in Chemistry for his work on protein structure. (He was very close to discovering the double helix structure of DNA when James Watson and James Crick announced their own discovery of its structure in 1953.) He was later awarded the 1962 Nobel Peace Prize for his efforts to ban the testing of nuclear weapons.

In his later years, Pauling became convinced that large doses of vitamin C would prevent disease, including the common cold. Most clinical research failed to show a connection, but Pauling continued to take large doses daily. He died in 1994, having spent a lifetime establishing a scientific legacy that few will ever equal.

Linus Pauling was one of the most influential chemists of the 20th century.

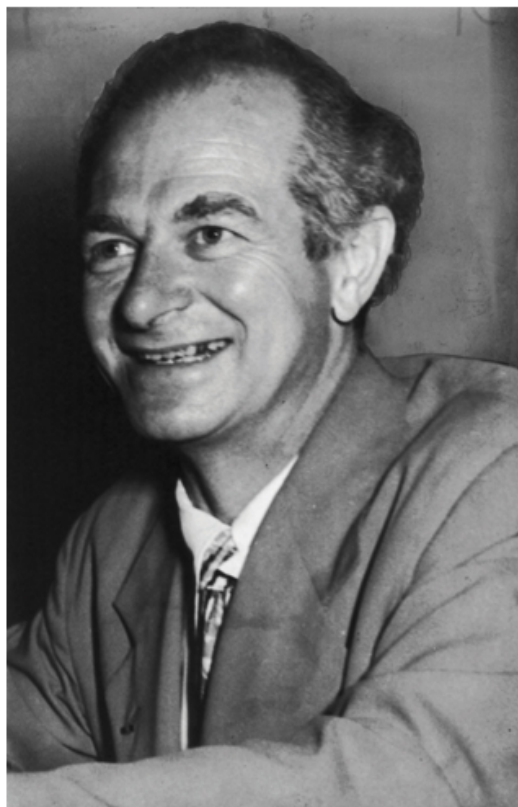

Ionization Energy

Another periodic trend that you will be expected to know is the trend for ionization energy. **Ionization energy** is defined as the amount of energy required to remove the most loosely bound electron of an atom. How tightly bound the electrons of an atom are will affect the amount of energy required to remove one of the valence electrons. Electrons that are closer to the nucleus are going to be more tightly held than those that are further away and will require more energy to pull them off of the atom. For this reason, we see that ionization energy decreases as you go down a family group and the atoms get larger. This same concept can be applied to atoms across a period.

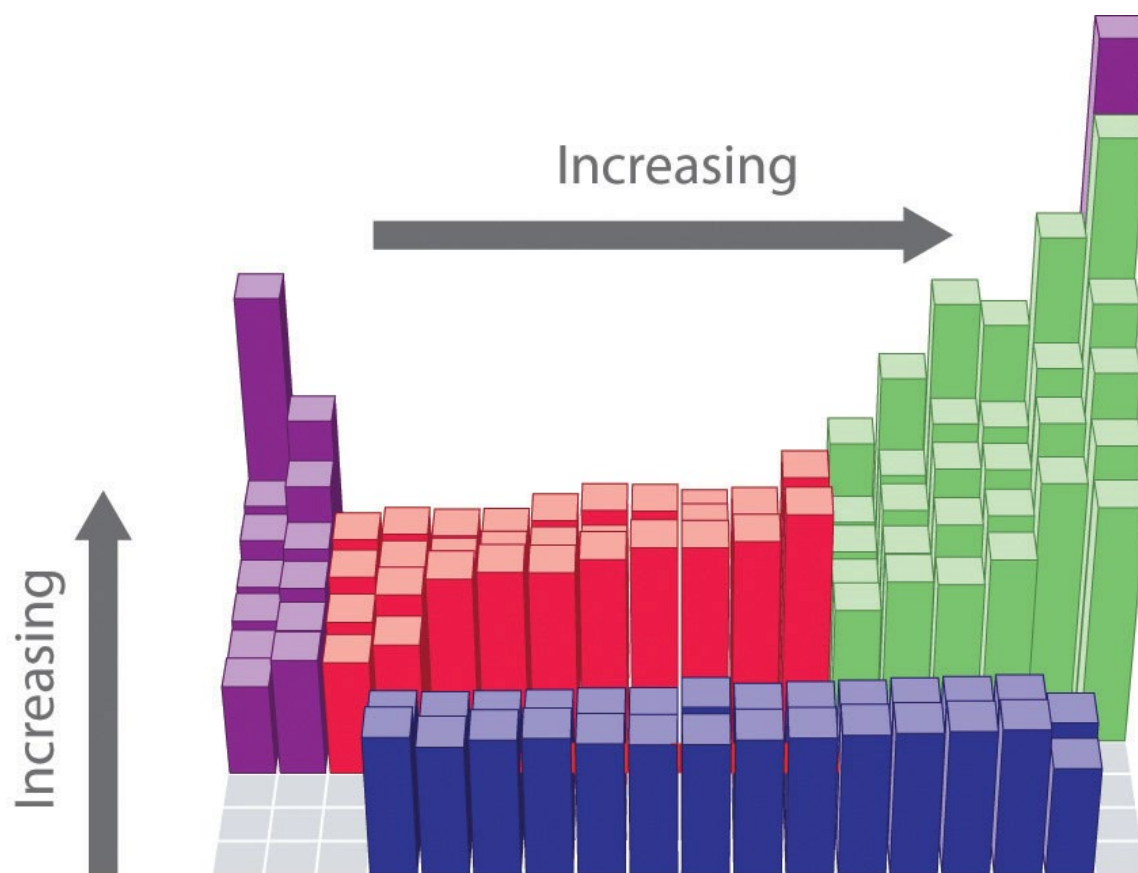

First ionization energy (kJ/mol)

■ s block ■ p block ■ d block ■ f block

Figure 2.19 First Ionization Energies for the Elements of the Periodic Table.

We will see that the highest ionization energy will be found on the right side of the period where the atoms are the smallest, and the lowest ionization energy on the left where the atoms have a larger radii. In general, ionization energy decreases as you go down a family group, and increases as you go across a period from left to right (Figure 2.19).

Metallic and Nonmetallic Character

Metallic character refers to the level of reactivity of a metal. Metals tend to lose electrons in chemical reactions, as indicated by their low ionization energies. Within a compound, metal atoms have relatively low attraction for electrons, as indicated by their low electronegativities. By following the trend summary in the figure below, you can see that the most reactive metals would reside in the lower left portion of the periodic table. The most reactive metal is cesium, which is not found in nature as a free element. It reacts explosively with water and will ignite spontaneously in air. Francium is below cesium in the alkali metal group, but is so rare that most of its properties have never been observed.

The metallic character increases as you go down a group. Since the ionization energy decreases going down a group (or increases going up a group), the increased ability for metals lower in a group to lose electrons makes them more reactive. In addition, the atomic radius increases going down a group, placing the outer electrons further away from the nucleus and making that electron less attracted by the nucleus.

Nonmetals tend to gain electrons in chemical reactions and have a high attraction for electrons within a compound. These tendencies are known as nonmetallic character. The most reactive nonmetals reside in the upper right portion of the periodic table. Since the noble gases are a special group because of their lack of reactivity, the element fluorine is the most reactive nonmetal. It is not found in nature as a free element. Fluorine gas reacts explosively with many other elements and compounds and is considered to be one of the most dangerous known substances.

Note that there is no clear division between metallic and ***nonmetallic*** character. As we move across the periodic table, there is an increasing tendency to accept electrons (nonmetallic) and a decrease in the possibility that an atom would give up one or more electrons.

Overall

- **Metallic character** refers to the level of reactivity of a metal to donate electrons during a chemical reaction.
- **Nonmetallic character** relates to the tendency of an element to accept electrons during chemical reactions.
- **Metallic character increases** going down a family group and **decreases** going across a period.
- **Nonmetallic character increases** going from left to right across the periodic table and **decreases** going down a family group.

The following figure summarizes all of the major periodic trends within the periodic table

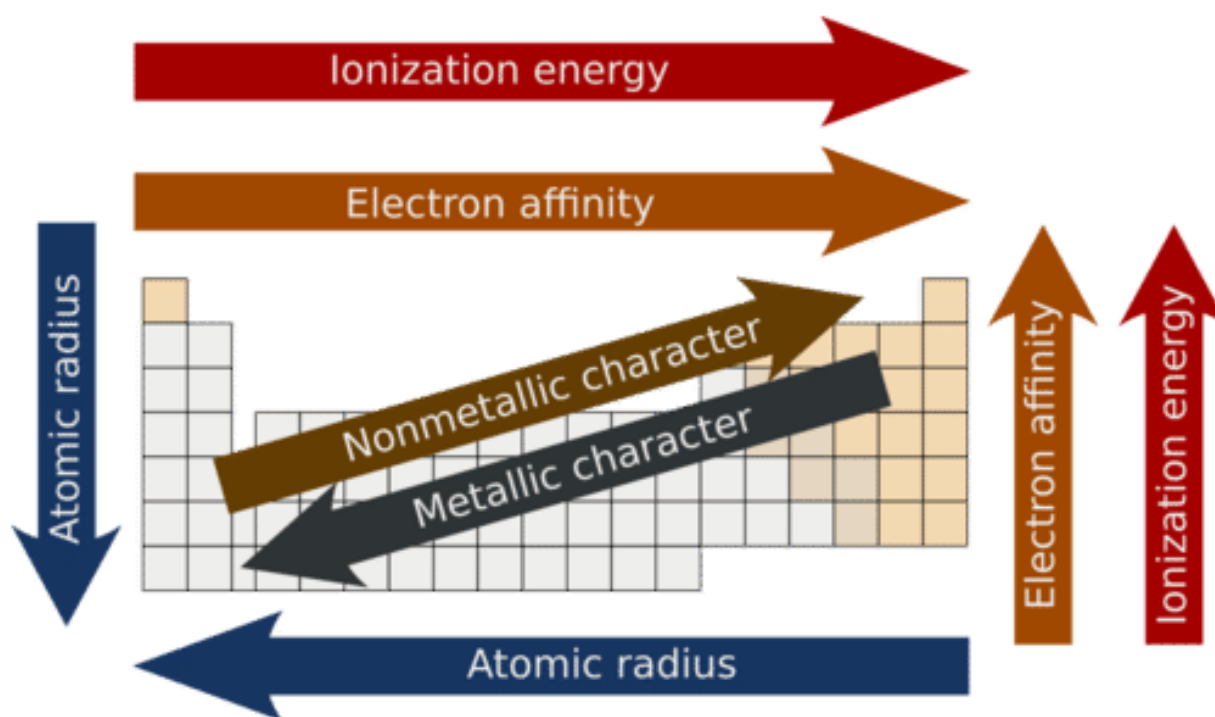

Figure 2.20 Summary of Major Periodic Trends

Section 2.10 Chapter Summary

Dalton's Atomic Theory proposed that matter is made up of tiny particles called atoms that cannot be broken into smaller pieces. During a chemical reaction, atoms are rearranged, but they do not break apart, nor are they created or destroyed. An **element**

is a substance that cannot be broken down into simpler chemical substances. There are about 90 naturally occurring elements known on Earth. The smallest unit of an element is the atom. All atoms of the same element are identical in mass and other properties, whereas atoms of different elements differ in mass and other properties.

The elements can be divided into three major classes: The metals, metalloids, and nonmetals. **Metals** are typically shiny, very dense, have high melting points, and are good conductors. **Nonmetals** are generally brittle, dull, have low melting points, and they are generally poor conductors. Metalloids have properties of both metals and nonmetals.

Dmitri Mendeleev organized the elements into a chart based on their similar characteristics and properties. Today this chart is known as the periodic table of the elements. Within the periodic table group, or **family of elements**, is a vertical column of the periodic table. Elements are placed into families due to their similar properties, characteristics, and reactivities. Group 1 elements are known as the alkali metals and are the most reactive elements of the metal class. Alkaline earth metals are found in group 2 and are almost as reactive as the group 1 metals. The transition metals are the larger block of elements extending from Groups 3-12 (also known as the group B elements). Transition metals have high melting points and boiling points, often form colored compounds that are highly stable, and they can serve as good catalysts. A catalyst is an agent that helps to speed up a chemical reaction without itself being changed in the process. Group 17 elements, known as **halogens**, contains very reactive nonmetals that often exist as diatomic elements (F_2 , Cl_2 , Br_2 , I_2). Group 18 elements, the **noble gases** are extremely stable, unreactive, and rarely form compounds.

Atoms are made up of extremely small subatomic particles called protons, neutrons, and electrons. **Protons** (positively charged particles), and neutrons (electrically neutral particles) form the core or **nucleus** of an atom. **Electrons** are extremely small, negatively charged particles that form an electron cloud, which orbits the nucleus. The **atomic number (Z)** refers to the number of protons present in an element and is the defining feature of an element. The atomic mass (A) of an element is the sum of the protons and neutrons within that element.

Atoms of the same element (have the same atomic number) that have different numbers of neutrons are called **isotopes**. Most elements exist as isotopes. In fact, over 3,500 isotopes are known for the different elements. The atomic mass reported on the periodic table is the relative mass of the different isotopes of an element based on their abundance on the Earth.

The valence shell of an element is the outermost electron shell. The electrons housed within the valence shell are the most reactive electrons in an atom and are essential for forming chemical bonds with other elements. There are a total of eight electrons that can be housed in the valence shell of any atom.

Due to the organization of the periodic table according to proton and electron configurations, a number of interesting elemental trends can be observed. Atomic size, as measured by the atomic radius of an atom, increases and you move down a family group, and decreases as you move from left to right down a period or a row on the periodic table. The **Electronegativity** of an atom is the measure of an atom's tendency to attract a bonding pair of electrons, and can be thought of as electron affinity. Electronegativity increases as you go from left to right across the periods of the periodic table and it tends to decrease as you move down family groups. **Ionization energy** is defined as the amount of energy required to remove the most loosely bound electron of an atom. Ionization energy tends to increase as you move across the periods of the periodic table from left to right, and decreases as you move down a family group. Metallic character refers to the level of reactivity of a metal, whereas nonmetallic character refers to the level of reactivity of nonmetals. The metallic character of the elements tends to go up as you move down a family group of elements and goes down as you move from left to right across a row of the periodic table. Concomitantly, nonmetallic character tends to go down as you move down a family group of elements and goes up as you move from the left to the right across the periodic table.

Homework Chapter 2

[Part 1: Atomic Structure](#)

Section 2.11 References

Chapter 2 materials have been adapted and modified from the following creative commons resources unless otherwise noted:

1. Anonymous. (2012) Introduction to Chemistry: General, Organic, and Biological (V1.0). Published under Creative Commons by-nc-sa 3.0. Available at: <http://2012books.lardbucket.org/books/introduction-to-chemistry-general-organic-and-biological/index.html>

2. Poulsen, T. (2010) Introduction to Chemistry. Published under Creative Commons by-nc-sa 3.0. Available at: <http://openedgroup.org/books/Chemistry.pdf>
 3. OpenStax (2015) Atoms, Isotopes, Ions, and Molecules: The Building Blocks. OpenStax CNX. Available at: <http://cnx.org/contents/be8818d0-2dba-4bf3-859a-737c25fb2c99@12>.
 4. LibreTexts (2017) Chem 121: Chapter 2 Atomic Structure. https://chem.libretexts.org/LibreTexts/Valley_City_State_University/Chem_121/Chapter_2%3A_Atomic_Structure/2.03%3A_Families_and_Periods_of_the_Periodic_Table
 5. Robson, G.(2006) Wikipedia. https://en.wikipedia.org/wiki/Electron_shell
 6. LibreTexts (2016) Physical and Theoretical Chemistry. https://chem.libretexts.org/Core/Physical_and_Theoretical_Chemistry/Quantum_Mechanics/09._The_Hydrogen_Atom/Atomic_Theory/Electrons_in_Atoms/Electronic_Orbitals
 7. High School Chemistry/Families on the Periodic Table. (2016) Wikibooks. https://en.wikibooks.org/wiki/High_School_Chemistry/Families_on_the_Periodic_Table#Alkali_Metals_Have_One_Electron_in_Their_Outer_Energy_Level
 8. 1. Anonymous. (2012) Principles of General Chemistry (V1.0). Published under Creative Commons by-nc-sa 3.0. Available at: <http://webmis.highland.cc.il.us/~jsullivan/principles-of-general-chemistry-v1.0/index.html>
 9. Key, J. (2018) Radioactivity. Published under Creative Commons by-nc-sa 4.0. Available at: <https://opentextbc.ca/introductorychemistry/chapter/radioactivity-2/>
 10. Rice University () Biological Effects of Radiation. Published under Creative Commons by-nc-sa 4.0. Available at: <https://opentextbc.ca/chemistry/chapter/21-6-biological-effects-of-radiation/>
-

Chapter 3: Radioactivity and Nuclear Chemistry

INTRODUCTION

Atomic theory in the nineteenth century presumed that nuclei had fixed compositions. But in 1896, the French scientist Henri Becquerel found that a uranium compound placed near a photographic plate made an image on the plate, even if the compound was wrapped in black cloth. He reasoned that the uranium compound was emitting some kind of radiation that passed through the cloth to expose the photographic plate. Further investigations showed that the radiation was a combination of particles and electromagnetic rays, with its ultimate source being the atomic nucleus. These emanations were ultimately called, collectively, **radioactivity**.

Following the somewhat serendipitous discovery of radioactivity by Becquerel, many prominent scientists began to investigate this new, intriguing phenomenon. Among them were Marie Curie (the first woman to win a Nobel Prize, and the only person to win two Nobel Prizes in different sciences—chemistry and physics), who was the first to coin the term “radioactivity,” and Ernest Rutherford (of gold foil experiment fame), who investigated and named three of the most common types of radiation. During the beginning of the twentieth century, many radioactive substances were discovered, the properties of radiation were investigated and quantified, and a solid understanding of radiation and nuclear decay was developed.

The spontaneous change of an unstable nuclide into another is **radioactive decay**. The unstable nuclide is called the **parent nuclide**; the nuclide that results from the decay is known as the **daughter nuclide**. The daughter nuclide may be stable, or it may decay itself. The radiation produced during radioactive decay is such that the daughter nuclide lies closer to the band of stability than the parent nuclide, so the location of a nuclide relative to the band of stability can serve as a guide to the kind of decay it will undergo (Figure 3.1).

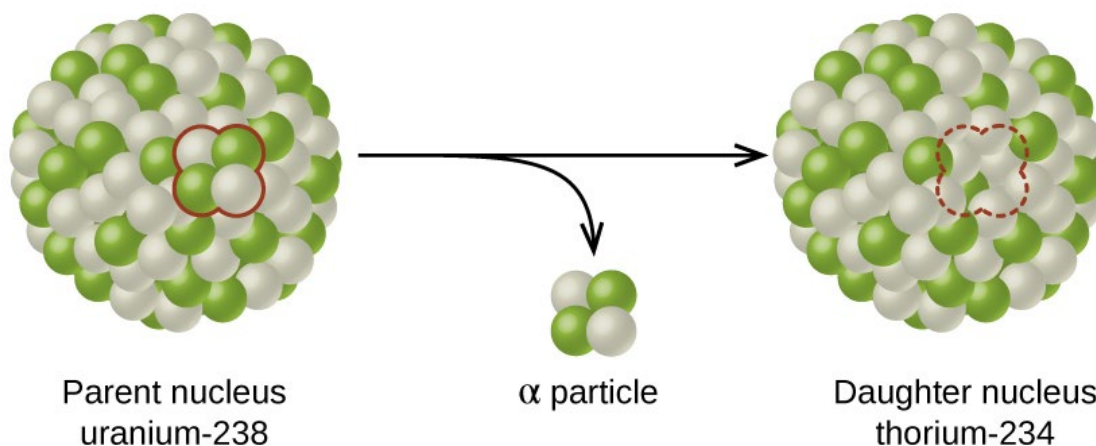
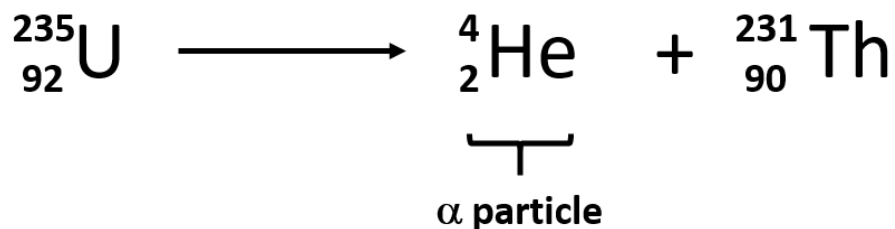

Figure 3.1 A nucleus of uranium-238 (the parent nuclide) undergoes α decay to form thorium-234 (the daughter nuclide). The alpha particle removes two protons (green) and two neutrons (gray) from the uranium-238 nucleus.

Section 3.1: Major Forms of Radioactivity

Alpha Particle (α)

Rutherford's experiments demonstrated that there are three main forms of radioactive emissions. The first is called an **alpha particle**, which is symbolized by the Greek letter α . An alpha particle is composed of two protons and two neutrons and is the same as a helium nucleus. (We often use ${}^4_2\text{He}$ to represent an alpha particle.) It has a 2+ charge. When a radioactive atom emits an alpha particle, the original atom's atomic number decreases by two (because of the loss of two protons), and its mass number decreases by four (because of the loss of four nuclear particles). We can represent the emission of an alpha particle with a chemical equation—for example, the alpha-particle emission of uranium-235 is as follows:



Rather than calling this equation a chemical equation, we call it a **nuclear equation** to emphasize that the change occurs in an atomic nucleus. How do we know that a product of this reaction is ${}_{90}^{231}\text{Th}$? We use the law of conservation of matter, which says that matter cannot be created or destroyed. This means we must have the same number of protons and neutrons on both sides of the nuclear equation. If our uranium nucleus loses 2 protons, there are 90 protons remaining, identifying the element as thorium. Moreover, if we lose four nuclear particles of the original 235, there are 231 remaining. Thus we use subtraction to identify the isotope of the Th atom—in this case, ${}_{90}^{231}\text{Th}$.

Beta Particle (β)

The second type of radioactive emission is called a beta particle, which is symbolized by the Greek letter β . A beta particle is an electron ejected from the nucleus (not from the shells of electrons about the nucleus) and has a -1 charge. We can also represent a beta particle as ${}_{-1}^0\text{e}$. The net effect of beta particle emission on a nucleus is that a neutron is converted to a proton. The overall mass number stays the same, but because the number of protons increases by one, the atomic number goes up by one. Carbon-14 decays by emitting a beta particle:

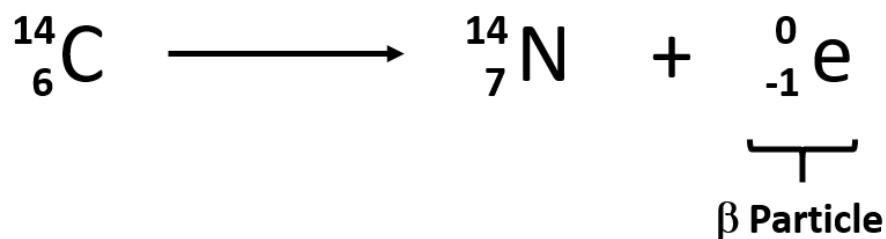

Again, the sum of the atomic numbers is the same on both sides of the equation, as is the sum of the mass numbers. (Note that the electron is assigned an “atomic number” of -1 , equal to its charge.)

Gamma Radiation (γ)

The third major type of radioactive emission is not a particle but rather a very energetic form of electromagnetic radiation called **gamma rays**, symbolized by the Greek letter γ . Electromagnetic radiation can be characterized into different categories based on the

wavelength and photon energies. The electromagnetic spectrum shown in figure 3.2 shows the major categories of electromagnetic radiation. Note that the human sensory adaptations of sight and hearing have evolved to detect electromagnetic radiation, with radio waves having wavelengths between 1 mm and 100 km and visible light having wavelengths between 380 - 700 nm. Technological advances have helped humankind utilize other forms of electromagnetic radiation including X-rays and microwaves.

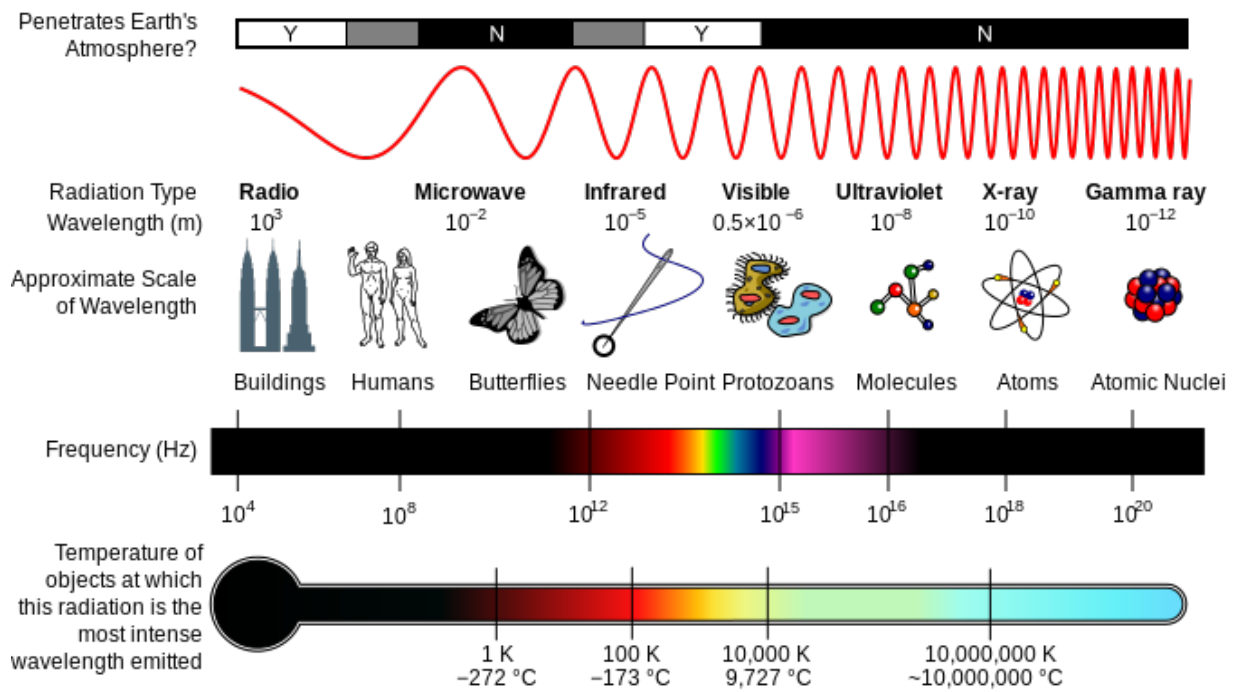

Figure 3.2 The Electromagnetic Spectrum. A diagram of the electromagnetic spectrum, showing various properties across the range of frequencies and wavelengths. Image Available from [Wikipedia](https://en.wikipedia.org/wiki/Electromagnetic_spectrum)

Some electromagnetic radiation with very short wavelengths are active enough that they may knock out electrons out of atoms in a sample of matter and make it electrically charged. The types of radiation that can do this are termed ionizing radiation. X-rays and Gamma rays are examples of ionizing radiation. Some radioactive materials, emit gamma radiation during their decay. For example, in the decay of radioactive technetium-99, a gamma ray is emitted. Note that in radioactive decay where the emission of gamma radiation occurs, that the identity of the parent material does not change, as no particles are physically emitted.



Sometimes the radioactive decay of a sample can result in the release of multiple forms of radioactivity. For example, in the radioactive decay of radon-222, both alpha and gamma radiation are emitted, with the latter having an energy of 8.2×10^{-14} J per nucleus decayed:



This may not seem like much energy, but if 1 mol of Rn atoms were to decay, the gamma ray energy would be 4.9×10^7 kJ!

Alpha, beta, and gamma emissions have different abilities to penetrate matter. The relatively large alpha particle is easily stopped by matter (although it may impart a significant amount of energy to the matter it contacts). Beta particles penetrate slightly into matter, perhaps a few centimeters at most. Gamma rays can penetrate deeply into matter and can impart a large amount of energy into the surrounding matter. Table 3.1 summarizes the properties of the three main types of radioactive emissions and Figure 3.3 summarizes the ability of each radioactive type to penetrate matter.

Table 3.1 The Three Main Forms of Radioactive Emissions

Characteristic	Alpha Particles	Beta Particles	Gamma Rays
Symbols	α , ${}^4_2\text{He}$	β , ${}^0_{-1}\text{e}$	γ
Identity	Helium nucleus	electron	Electromagnetic radiation
Charge	2+	1-	None
Mass Number	4	0	0
Penetrating Power	Minimal (will not penetrate skin)	Short (will penetrate skin and some tissues slightly)	Deep (will penetrate tissues deeply)

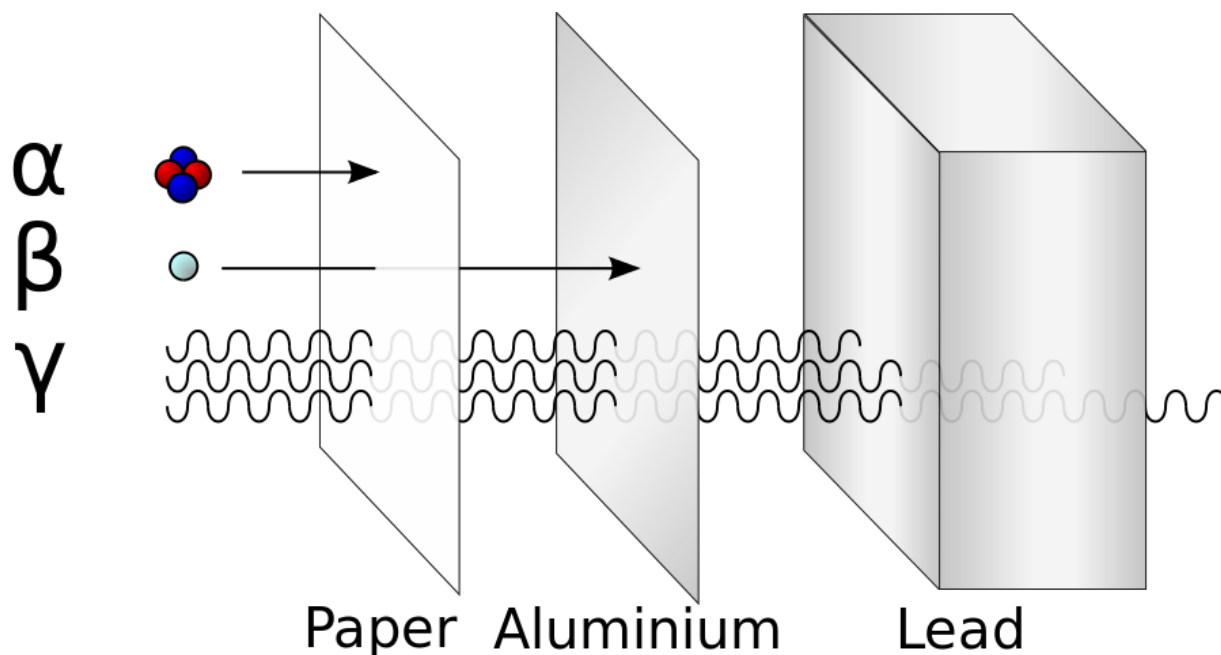
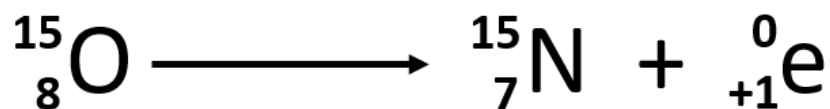

Figure 3.3 Illustration of the relative abilities of three different types of ionizing radiation to penetrate solid matter. Typical alpha particles (α) are stopped by a sheet of paper, while beta particles (β) are stopped by an aluminum plate. Gamma radiation (γ) is damped when it penetrates lead. Figure provided by [Stannered](#)

Positron Emission (β^+ decay) and Electron Capture

In addition to the three major types of radioactive particles listed above, two additional less common types of emissions have been discovered. These include **positron emission** and **electron capture**.

Positron emission (β^+ decay) is the emission of a positron from the nucleus. Oxygen-15 is an example of a nuclide that undergoes positron emission:



Positron emission is observed for nuclides in which the n:p ratio is low. These nuclides lie below the band of stability. Positron decay is the conversion of a proton into a neutron

with the emission of a positron. The n:p ratio increases, and the daughter nuclide lies closer to the band of stability than did the parent nuclide. The positron has the mass of an electron, but a positive charge. Thus, the overall mass of the nuclide doesn't change, but the atomic number is decreased by one, which causes a change in the elemental identity of the daughter isotope.

Electron capture occurs when one of the inner electrons in an atom is captured by the atom's nucleus. For example, potassium-40 undergoes electron capture:

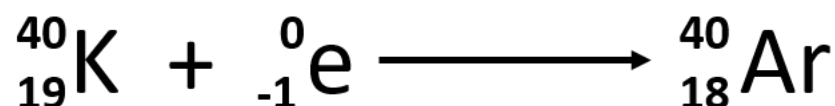

Electron capture occurs when an inner shell electron combines with a proton and is converted into a neutron. The loss of an inner shell electron leaves a vacancy that will be filled by one of the outer electrons. As the outer electron drops into the vacancy, it will emit energy. In most cases, the energy emitted will be in the form of an X-ray. Like positron emission, electron capture occurs for "proton-rich" nuclei that lie below the band of stability. Electron capture has the same effect on the nucleus as does positron emission: The atomic number is decreased by one and the mass number does not change. This increases the n:p ratio, and the daughter nuclide lies closer to the band of stability than did the parent nuclide. Whether electron capture or positron emission occurs is difficult to predict. The choice is primarily due to kinetic factors, with the one requiring the smaller activation energy being the one more likely to occur.

Figure 3.4 summarizes these types of decay, along with their equations and changes in atomic and mass numbers.

Nuclear Fission

Occasionally, an atomic nucleus breaks apart into smaller pieces in a radioactive process called spontaneous fission (or fission). Typically, the daughter isotopes produced by fission are a varied mix of products, rather than a specific isotope as with alpha and beta particle emission. Often, fission produces excess neutrons that will sometimes be captured

Type	Nuclear equation	Representation	Change in mass/atomic numbers
Alpha decay	${}^A_Z X \rightarrow {}^4_2 \text{He} + {}^{A-4}_{Z-2} Y$		A: decrease by 4 Z: decrease by 2
Beta decay	${}^A_Z X \rightarrow {}^0_{-1} e + {}^{A}_{Z+1} Y$		A: unchanged Z: increase by 1
Gamma decay	${}^A_Z X \rightarrow {}^0_0 \gamma + {}^A_Z Y$		A: unchanged Z: unchanged
Positron emission	${}^A_Z X \rightarrow {}^0_{+1} e + {}^{A}_{Z-1} Y$		A: unchanged Z: decrease by 1
Electron capture	${}^A_Z X + {}^0_{-1} e \rightarrow {}^{A}_{Z-1} Y + \gamma$		A: unchanged Z: decrease by 1

Figure 3.4. Summary of the type, nuclear equation, representation, and any changes in the mass or atomic numbers for various types of decay.

by other nuclei, possibly inducing additional radioactive events. Uranium-235 undergoes spontaneous fission to a small extent. One typical reaction is:

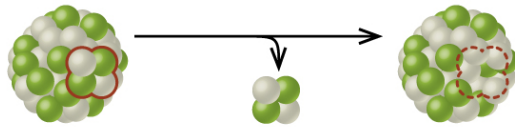
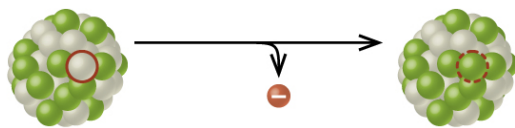
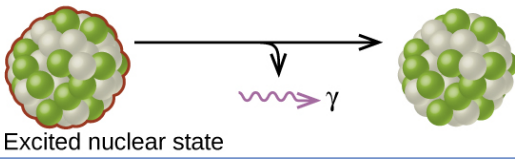
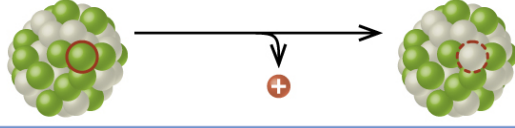
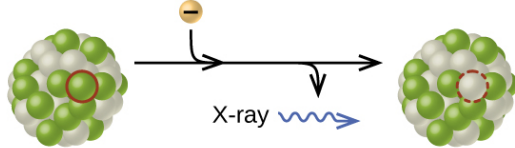

where ${}^1_0 \text{n}$ is a neutron. As with any nuclear process, the sums of the atomic numbers and mass numbers must be the same on both sides of the equation. Spontaneous fission is found only in large nuclei. The smallest nucleus that exhibits spontaneous fission is lead-208. (Fission is the radioactive process used in nuclear power plants and one type of nuclear bomb.)

Section 3.2: Radioactive Half Lives

Each radioactive nuclide has a characteristic, constant **half-life** ($t_{1/2}$), the time required for half of the atoms in a sample to decay. An isotope's half-life allows us to determine how long a sample of a useful isotope will be available, and how long a sample of an undesirable or dangerous isotope must be stored before it decays to a low-enough radiation level that is no longer a problem.

For example, cobalt-60, an isotope that emits gamma rays used to treat cancer, has a half-life of 5.27 years (Figure 3.5). In a given cobalt-60 source, since half of the ${}^{60}_{27}\text{Co}$ nuclei decay every 5.27 years, both the amount of material and the intensity of the radiation emitted is cut in half every 5.27 years. Note that for a given substance, the intensity of radiation that it produces is directly proportional to the rate of decay of the substance and the amount of the substance. Thus, a cobalt-60 source that is used for cancer treatment must be replaced regularly to continue to be effective.

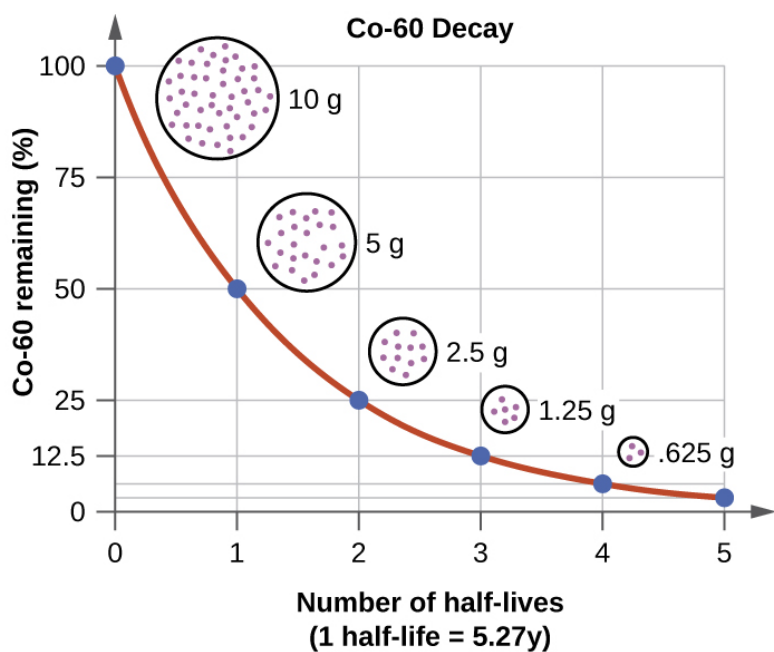

Figure 3.5. The Decay of Cobalt-60. For cobalt-60, which has a half-life of 5.27 years, 50% remains after 5.27 years (one half-life), 25% remains after 10.54 years (two half-lives), 12.5% remains after 15.81 years (three half-lives), and so on. Note that every half-life is the same length of time.

Since every half-life for a radionuclide is the same length of time, we can use the following equation to calculate how much radioactive nuclide is remaining after the passage of any number (n) of half-lives:

$$\text{Isotope Remaining} = \left(\frac{1}{2}\right)^n \times \text{Starting Material}$$

- Where n = the number of half-lives determined

Practice Problem:

Question: The half-life of Zn-71 is 2.4 minutes. If one had 100.0 g at the beginning, how many grams would be left after 7.2 minutes has elapsed?

Solution:

Step 1. Determine the number of half-lives that have passed: number of half-lives = time passed divided by the half-life (Be sure that the time units match!!)

$$\frac{7.2 \text{ min}}{2.4 \text{ min}} = 3 \text{ half-lives}$$

Step 2. Use the Isotope Remaining equation to solve for how much isotope will remain after the number of half-lives determined in step 1 have passed.

$$\begin{aligned} \text{Isotope Remaining} &= \left(\frac{1}{2}\right)^3 \times 100.0 \text{ g} \\ &= \left(\frac{1}{2}\right) \left(\frac{1}{2}\right) \left(\frac{1}{2}\right) \times 100.0 \text{ g} = 12.5 \text{ g} \end{aligned}$$

Section 3.3: Biological Effects of Radiation Exposure

There is a large difference in the magnitude of the biological effects of **nonionizing radiation** (for example, light and microwaves) and **ionizing radiation**, emissions energetic enough to knock electrons out of molecules (for example, α and β particles, γ rays, X-rays, and high-energy ultraviolet radiation) (Figure 3.6).

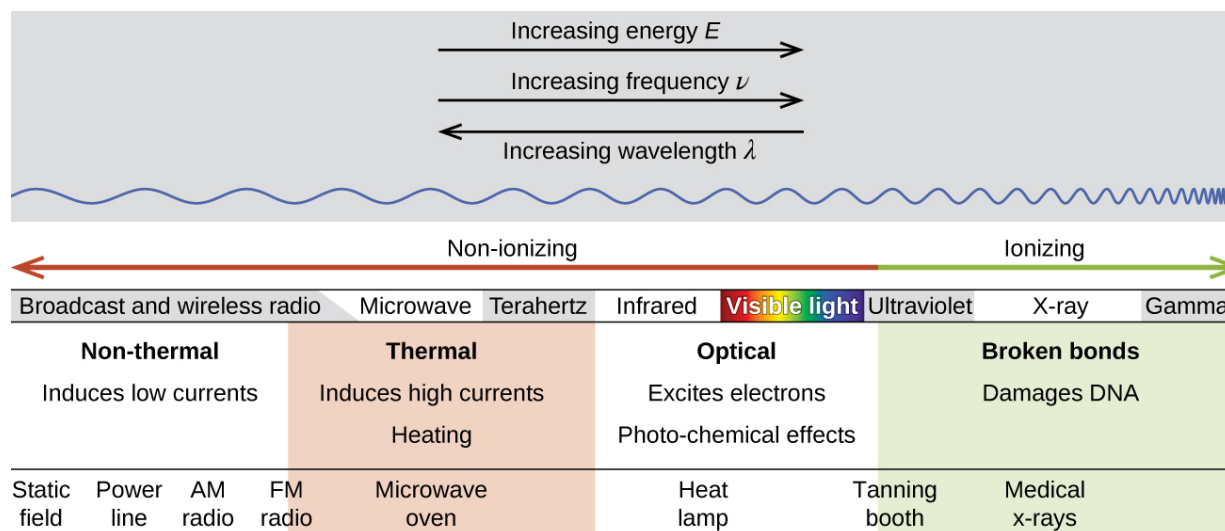

Figure 3.6. Damaging Effects of Ionizing Radiation. Lower frequency, lower-energy electromagnetic radiation is nonionizing, and higher frequency, higher-energy electromagnetic radiation is ionizing.

Energy absorbed from nonionizing radiation speeds up the movement of atoms and molecules, which is equivalent to heating the sample. Although biological systems are sensitive to heat (as we might know from touching a hot stove or spending a day at the beach in the sun), a large amount of nonionizing radiation is necessary before dangerous levels are reached. Ionizing radiation, however, may cause much more severe damage by breaking bonds or removing electrons in biological molecules, disrupting their structure and function (Figure 3.7).

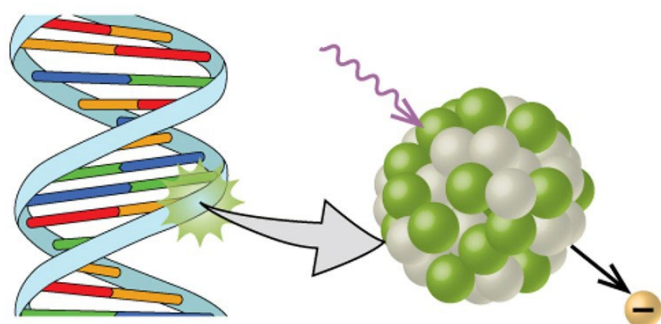

Figure 3.7. Biological Effects of Ionizing Radiation. Ionizing radiation can directly damage a biomolecule by ionizing it or breaking its bonds

Radiation can harm either the whole body (somatic damage) or eggs and sperm (genetic damage). Its effects are more pronounced in cells that reproduce rapidly, such as the stomach lining, hair follicles, bone marrow, and embryos. This is why patients undergoing radiation therapy often feel nauseous or sick to their stomach, lose hair, have bone aches, and so on, and why particular care must be taken when undergoing radiation therapy during pregnancy.

Section 3.4: Uses of Radioactive Isotopes

Radioactive isotopes have the same chemical properties as stable isotopes of the same element, but they emit radiation, which can be detected. If we replace one (or more) atom(s) with radioisotope(s) in a compound, we can track them by monitoring their radioactive emissions. This type of compound is called a **radioactive tracer** (or **radioactive label**). Radioisotopes are used to follow the paths of biochemical reactions or to determine how a substance is distributed within an organism. Radioactive tracers are also used in many medical applications, including both diagnosis and treatment. They are also used in many other industries to measure engine wear, analyze the geological formation around oil wells, and much more.

Radioisotopes have revolutionized medical practice, where they are used extensively. Over 10 million nuclear medicine procedures and more than 100 million nuclear medicine tests are performed annually in the United States. Four typical examples of radioactive tracers used in medicine are technetium-99 ($^{99}_{43}\text{Tc}$), thallium-201 ($^{201}_{81}\text{Tl}$), iodine-131 ($^{131}_{53}\text{I}$), and sodium-24 ($^{24}_{11}\text{Na}$). Damaged tissues in the heart, liver, and lungs absorb certain compounds of technetium-99 preferentially. After it is injected, the location of the technetium compound, and hence the damaged tissue, can be determined by detecting the γ rays emitted by the Tc-99 isotope. Thallium-201 (Figure 3.8) becomes concentrated in healthy heart tissue, so the two isotopes, Tc-99 and Tl-201, are used together to study heart tissue. Iodine-131 concentrates in the thyroid gland, the liver, and some parts of the brain. It can therefore be used to monitor goiter and treat thyroid conditions, such as Grave's disease, as well as liver and brain tumors. Salt solutions containing compounds of sodium-24 are injected into the bloodstream to help locate obstructions to the flow of blood.



Figure 3.8. Administering thallium-201 to a patient and subsequently performing a stress test offer medical professionals an opportunity to visually analyze heart function and blood flow. (credit: modification of work by "BlueOctane"/Wikimedia Commons)

Radioisotopes used in medicine typically have short half-lives—for example, Tc-99 has a half-life of 6.01 hours. This makes Tc-99 essentially impossible to store and prohibitively expensive to transport, so it is made on-site instead. Hospitals and other medical facilities use Mo-99 (which is primarily extracted from U-235 fission products) to generate Tc-99. Mo-99 undergoes β decay with a half-life of 66 hours, and the Tc-99 is then chemically extracted (Figure 3.9). The parent nuclide Mo-99 is part of a molybdate ion, MoO_4^{2-} ; when it decays, it forms the pertechnetate ion, TcO_4^- . These two water-soluble ions are separated by column chromatography, with the higher charge molybdate ion adsorbing onto the alumina in the column, and the lower charge pertechnetate ion passing through the column in the solution. A few micrograms of Mo-99 can produce enough Tc-99 to perform as many as 10,000 tests.

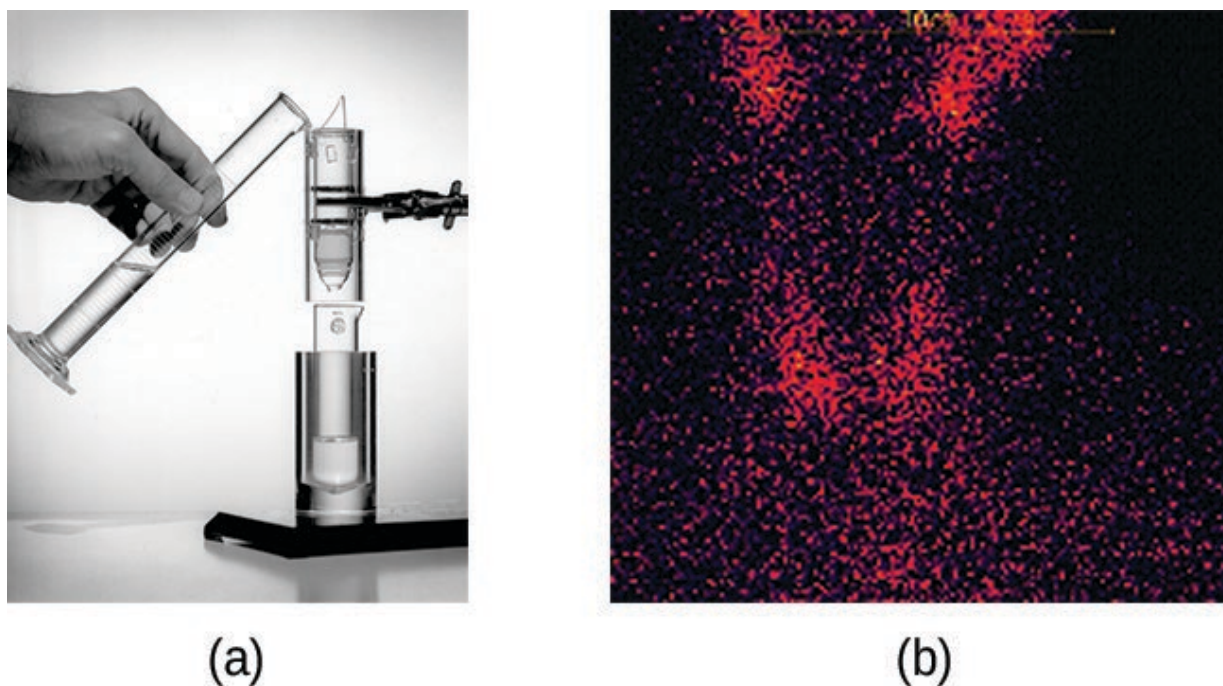

Figure 3.9. (a) The first Tc-99m generator (circa 1958) is used to separate Tc-99 from Mo-99. The MoO_4^{2-} is retained by the matrix in the column, whereas the TcO_4^- passes through and is collected. (b) Tc-99 was used in this scan of the neck of a patient with Grave's disease. The scan shows the location of high concentrations of Tc-99. (credit a: modification of work by the Department of Energy; credit b: modification of work by "MBq"/Wikimedia Commons)

Positron emission tomography (PET) scans use radiation to diagnose and track health conditions and monitor medical treatments by revealing how parts of a patient's body function (Figure 3.10). To perform a PET scan, a positron-emitting radioisotope is produced in a cyclotron and then attached to a substance that is used by the part of the body being investigated. This "tagged" compound, or **radiotracer**, is then administered to the patient (injected via IV or breathed in as a gas), and how it is used by the tissue reveals how that organ or other area of the body functions.

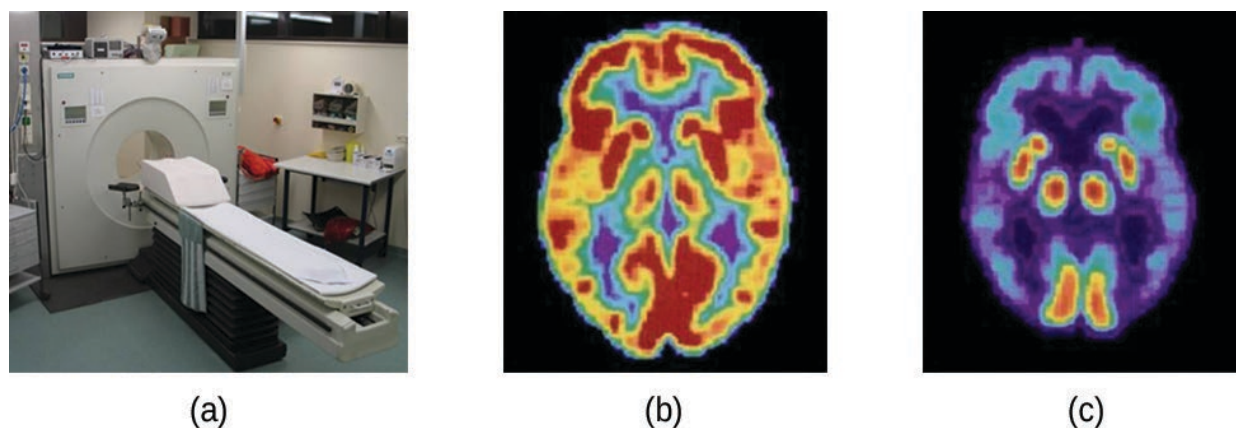

Figure 3.10. A PET scanner (a) uses radiation to provide an image of how part of a patient's body functions. The scans it produces can be used to image a healthy brain (b) or can be used for diagnosing medical conditions such as Alzheimer's disease (c). (credit a: modification of work by Jens Maus)

For example, F-18 is produced by proton bombardment of ^{18}O ($^{18}_8\text{O} + ^1_1\text{p} \rightarrow ^{18}_9\text{F} + ^1_0\text{n}$) and incorporated into a glucose analog called fludeoxyglucose (FDG). How FDG is used by the body provides critical diagnostic information; for example, since cancers use glucose differently than normal tissues, FDG can reveal cancers. The ^{18}F emits positrons that interact with nearby electrons, producing a burst of gamma radiation. This energy is detected by the scanner and converted into a detailed, three-dimensional, color image that shows how that part of the patient's body functions. Different levels of gamma radiation produce different amounts of brightness and colors in the image, which can then be interpreted by a radiologist to reveal what is going on. PET scans can detect heart damage and heart disease, help diagnose Alzheimer's disease, indicate the part of a brain that is affected by epilepsy, reveal cancer, show what stage it is, and how much it has spread, and whether treatments are effective. Unlike magnetic resonance imaging and X-rays, which only show how something looks, the big advantage of PET scans is that they

show how something functions. PET scans are now usually performed in conjunction with a computed tomography scan.

Radioisotopes can also be used, typically in higher doses than as a tracer, as treatment. **Radiation therapy** is the use of high-energy radiation to damage the DNA of cancer cells, which kills them or keeps them from dividing (Figure 3.11). A cancer patient may receive **external beam radiation therapy** delivered by a machine outside the body, or **internal radiation therapy (brachytherapy)** from a radioactive substance that has been introduced into the body. Note that **chemotherapy** is similar to internal radiation therapy in that the cancer treatment is injected into the body, but differs in that chemotherapy uses chemical rather than radioactive substances to kill the cancer cells.

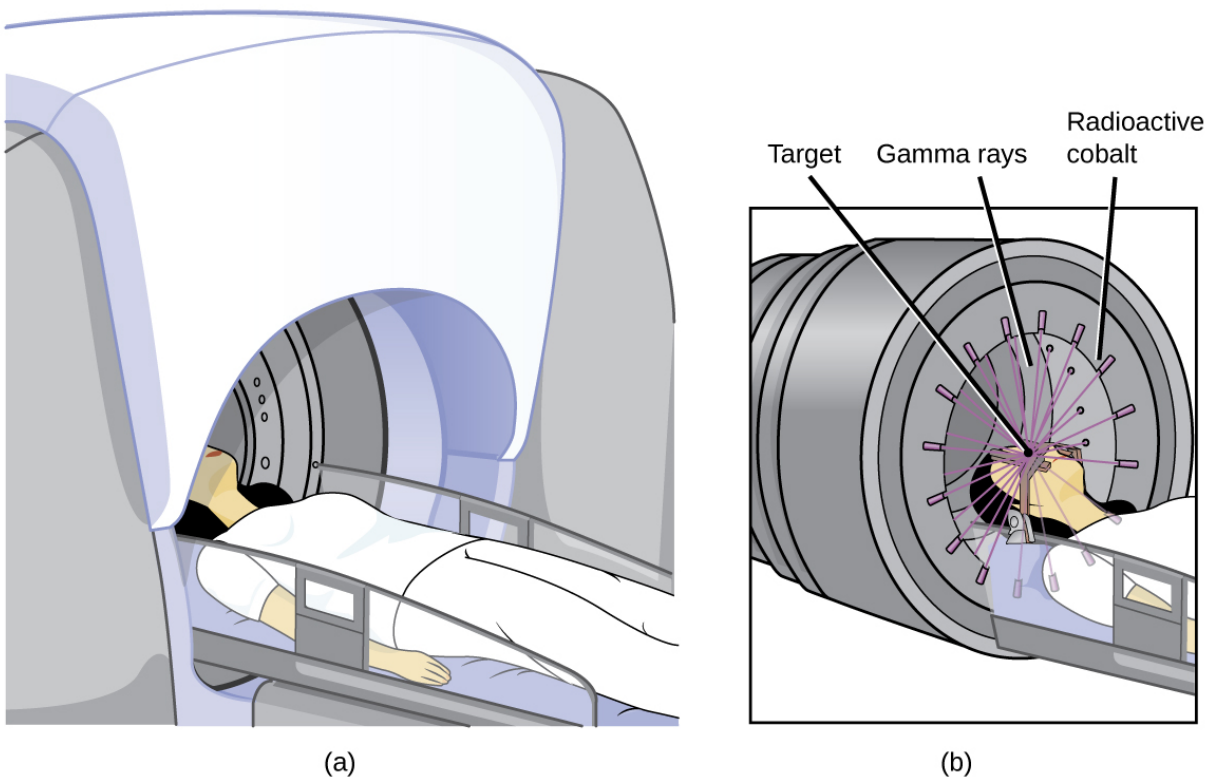

Figure 3.11. The cartoon in (a) shows a cobalt-60 machine used in the treatment of cancer. The diagram in (b) shows how the gantry of the Co-60 machine swings through an arc, focusing radiation on the targeted region (tumor) and minimizing the amount of radiation that passes through nearby regions.

Cobalt-60 is a synthetic radioisotope produced by the neutron activation of Co-59, which then undergoes β decay to form Ni-60, along with the emission of γ radiation. The overall process is:

The overall decay scheme for this is shown graphically in Figure 3.12.

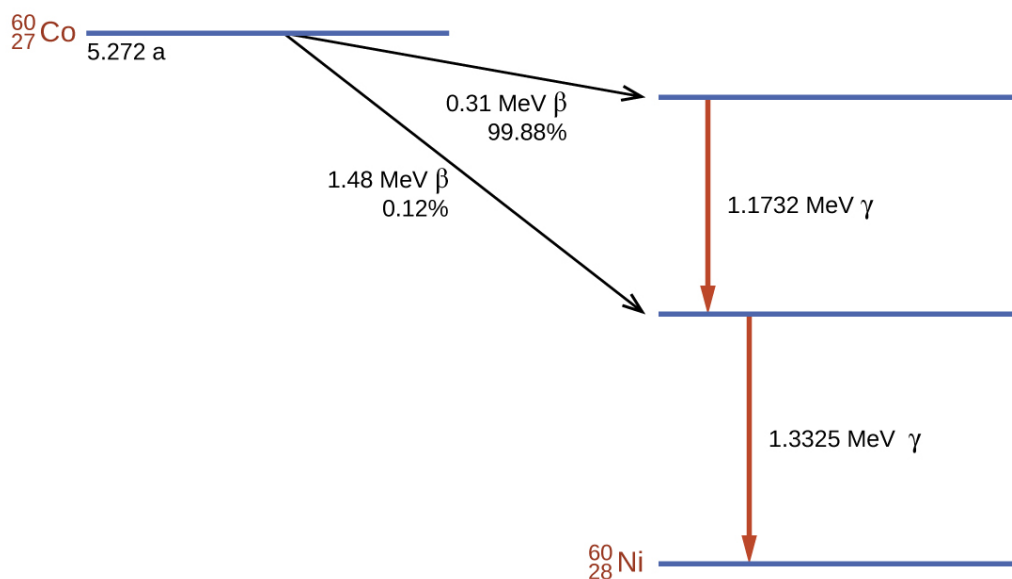
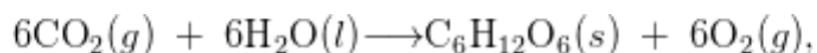

Figure 3.12. Co-60 undergoes a series of radioactive decays. The γ emissions are used for radiation therapy.

Radioisotopes are used in diverse ways to study the mechanisms of chemical reactions in plants and animals. These include labeling fertilizers in studies of nutrient uptake by plants and crop growth, investigations of digestive and milk-producing processes in cows, and studies on the growth and metabolism of animals and plants.

For example, the radioisotope C-14 was used to elucidate the details of how photosynthesis occurs. The overall reaction is:



but the process is much more complex, proceeding through a series of steps in which various organic compounds are produced. In studies of the pathway of this reaction,

plants were exposed to CO₂ containing a high concentration of ¹⁴C. At regular intervals, the plants were analyzed to determine which organic compounds contained carbon-14 and how much of each compound was present. From the time sequence in which the compounds appeared and the amount of each present at given time intervals, scientists learned more about the pathway of the reaction.

Commercial applications of radioactive materials are equally diverse (Figure 3.13). They include determining the thickness of films and thin metal sheets by exploiting the penetration power of various types of radiation. Flaws in metals used for structural purposes can be detected using high-energy gamma rays from cobalt-60 in a fashion similar to the way X-rays are used to examine the human body. In one form of pest control, flies are controlled by sterilizing male flies with γ radiation so that females breeding with them do not produce offspring. Many foods are preserved by radiation that kills microorganisms that cause the foods to spoil.

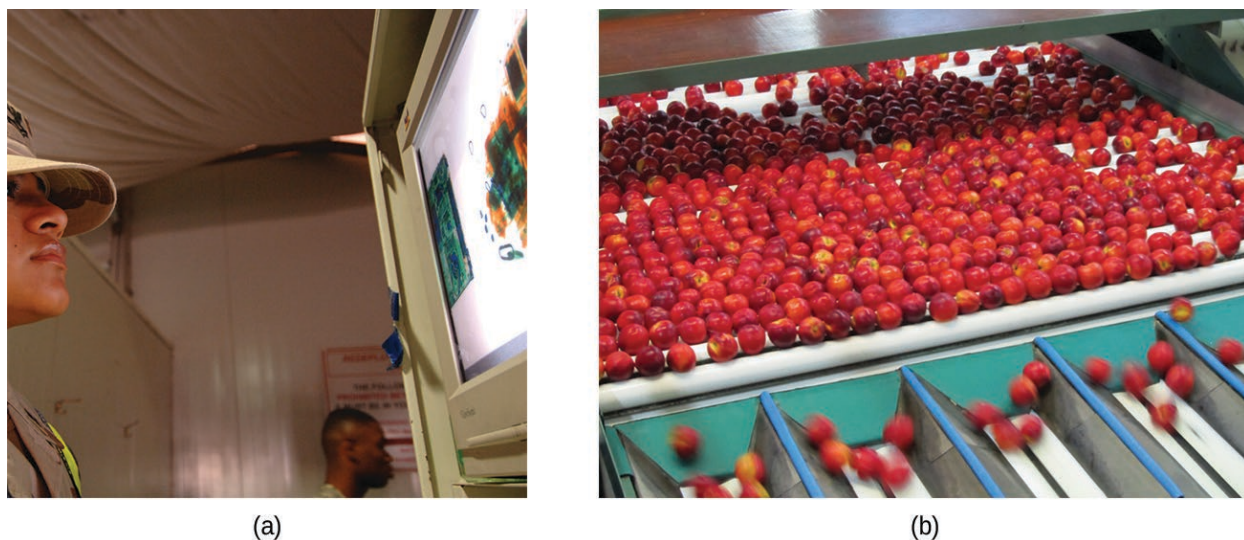

Figure 3.13. Common commercial uses of radiation include (a) X-ray examination of luggage at an airport and (b) preservation of food. (credit a: modification of work by the Department of the Navy; credit b: modification of work by the US Department of Agriculture)

Americium-241, an α emitter with a half-life of 458 years, is used in tiny amounts in ionization-type smoke detectors (Figure 3.14). The α emissions from Am-241 ionize the air between two electrode plates in the ionizing chamber. A battery supplies a potential that causes movement of the ions, thus creating a small electric current. When smoke

enters the chamber, the movement of the ions is impeded, reducing the conductivity of the air. This causes a marked drop in the current, triggering an alarm.

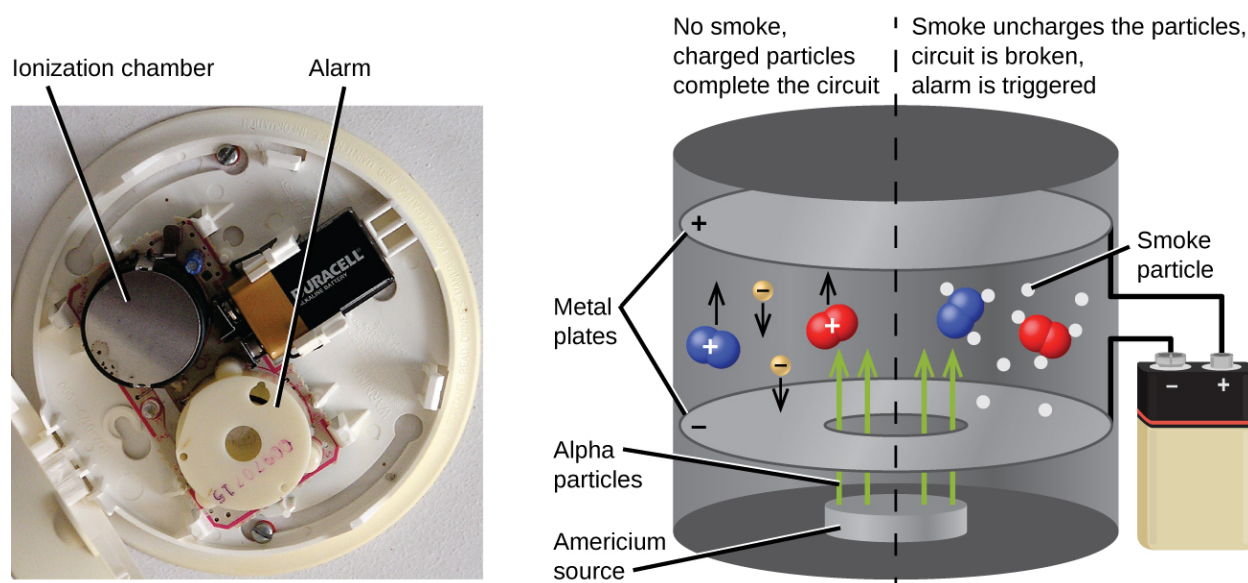

Figure 3.14. Inside a smoke detector, Am-241 emits α particles that ionize the air, creating a small electric current. During a fire, smoke particles impede the flow of ions, reducing the current and triggering an alarm. (credit a: modification of work by "Muffet"/Wikimedia Commons)

Section 3.5: Chapter Summary

Radioactivity is defined as the emission of particles and electromagnetic rays from the nucleus of an unstable atom. Six types of radiation produced during nuclear decay were presented within this chapter and include:

- **alpha (α) decay** which is composed of two protons and two neutrons and has a +2 charge.
- **beta (β) decay** which is an electron ejected from the nucleus (not from the shells of electrons about the nucleus) and has a -1 charge and no mass. Within the nucleus a neutron emits the electron and is converted into a proton in the process.
- **gamma (γ) decay** which is characterized by the emission of ionizing radiation and does not contain mass or charge.

- **positron (β^+) emission** which is a positron ejected from the nucleus and has a +1 charge and no mass. Within the nucleus a proton emits the positron and is converted into a neutron in the process.
- **electron capture** occurs when an inner shell electron combines with a proton and is converted into a neutron. The loss of an inner shell electron leaves a vacancy that will be filled by one of the outer electrons. As the outer electron drops into the vacancy, it will emit energy often in the form of X-rays.
- **nuclear fission** occurs when an atomic nucleus breaks apart into smaller pieces in a radioactive process that releases excess neutrons.

Each radioactive nuclide has a characteristic, constant **half-life ($t_{1/2}$)**, the time required for half of the atoms in a sample to decay. The equation below can be used to determine how much isotope will remain after the passage of a given number of half-lives

$$\text{Isotope Remaining} = \left(\frac{1}{2}\right)^n \times \text{Starting Material}$$

- *Where n = the number of half-lives determined*

Radioactive emissions can cause damage to biological systems by causing the breakdown of proteins and DNA. This can lead to cellular and genetic damage and increase a person's risk for diseases like cancer. However, when used in small quantities and in controlled settings, **radioactive tracers** and treatments have proven to be revolutionary for the medical field. For example, **Radiation therapy** is the use of high-energy radiation to damage the DNA of cancer cells, which kills them or keeps them from dividing. **Radioactive tracers** have also been very useful in evaluating heart disease, thyroid dysfunction, and other blood disorders. **Positron emission tomography (PET)** scans use radiation to diagnose and track health conditions and monitor medical treatments by revealing how parts of a patient's body function and X-rays have long been used to visualize breaks in bones and cavities in teeth.

Section 3.6: References

Unless otherwise noted, resources for this chapter have been modified from the following creative commons resources:

1. OpenStax . (2016) Chapter 21 - Nuclear Chemistry. [Chemistry](#) by Rice University is licensed under a [Creative Commons Attribution 4.0 International](#) Accessed, Dec 1st, 2018 from: <https://opentextbc.ca/chemistry/chapter/introduction-2/>

Chapter 4: Ions and Ionic Compounds

Section 4.1: Introduction to the Octet Rule

Up until now we have been discussing only the elemental forms of atoms which are neutrally charged. This is because the number of electrons (negative in charge) is equal to the number of protons (positive in charge). The overall charge on the atom is zero, because the magnitude of the negative charge is the same as the magnitude of the positive charge. This one-to-one ratio of charges is not, however, the most common state for many elements. Deviations from this ratio result in charged particles called **ions**.

Throughout nature, things that are high in energy tend to move toward lower energy states. Lower energy configurations are more stable, so things are naturally drawn toward them. For atoms, these lower energy states are represented by the noble gas elements. These elements have electron configurations characterized by full valence electron configurations. This makes them stable and unreactive. They are already at a low energy state, so they tend to stay as they are.

The elements in the other groups have valence electron configurations that are not full, so they are unstable when compared to the noble gases. This instability drives them toward the lower energy states represented by the noble gases that are nearby in the periodic table. In these lower energy states, the outermost energy level has eight electrons (an "octet"). The tendency of an atom toward a configuration in which it possesses eight valence electrons is referred to as the "**Octet Rule**."

There are two ways for an atom that does not have an octet of valence electrons to obtain an octet in its outer shell. One way is the transfer of electrons between two atoms until both atoms have octets. Because some atoms will lose electrons and some atoms will gain electrons, there is no overall change in the number of electrons, but with the transfer of electrons the individual atoms acquire a nonzero electric charge. Those that lose electrons become positively charged, and those that gain electrons become negatively charged. Recall that atoms carrying positive or negative charges are called **ions**. If an atom has gained one or more electrons, it is negatively charged and is called an **anion**. If an atom has lost one or more electrons, it is positively charged and is called a **cation**. Because opposite charges attract (while like charges repel), these oppositely charged ions attract each other, forming **ionic bonds**. The resulting compounds are called ionic compounds.

The second way for an atom to obtain an octet of electrons is by sharing electrons with another atom. These shared electrons simultaneously occupy the outermost shell of both atoms. The bond made by electron sharing is called a covalent bond. Covalent bonding and covalent compounds will be discussed in Chapter 4 "Covalent Bonding and Simple Molecular Compounds".

Electron-Dot Symbols

For each element on the periodic table, it is possible to predict the number of valence shell electrons that they will contain. When looking at the periodic table, it is divided into main group elements and transition elements. The main group elements are numbered IA to VIIIA, and their number of valence shell electrons correspond to their group number (Fig 4.1). For example all of the elements in the halogen family belong to group VIIA and correspondingly have 7 electrons in their valence shell. For all of the transition elements and the inner transition elements, they have a total of 2 electrons in their valence shell.

Although it is entirely possible to define the number of valence electrons in an atom through numbers, sometimes it is helpful to have a graphical representation. The graphical notation used for valence electrons is called an **Electron-Dot Symbol**. To draw an electron dot symbol, start with the abbreviation for the element of interest as the center, signifying the nucleus of the atom. From there, identify the number of valence electrons the atom has according to its position on the periodic table, and then add a single dot for each valence electron around the element (Fig. 4.2). Students often want to place these electron dots around the element randomly, but it is useful to use the four cardinal directions as a guide. First place single electrons around the atom in each of the four cardinal positions until you run out of electrons. For elements that have more than four valence electrons, you will begin pairing them in the four cardinal directions. Note that the noble gases have complete octets and will have a total of 8 electrons in their valence shell (Fig 4.2).

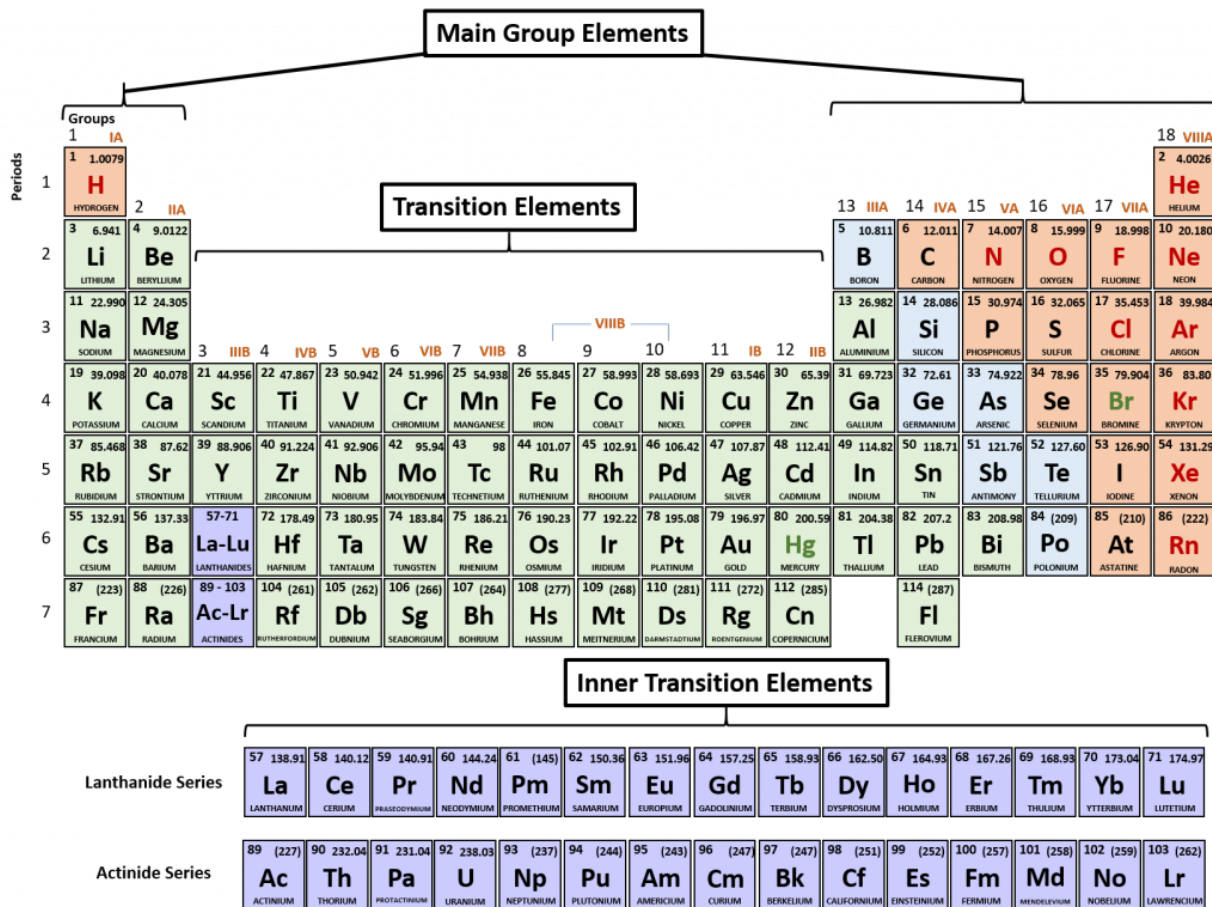

Figure 4.1 Periodic Table of the Elements. Main group, transition and inner transition elements are indicated.



Figure 4.2 Electron Dot Symbols. Electron Dot Symbols are shown for Carbon through Neon on the Periodic Table. Note that a single electron will be placed in each of the four cardinal directions before electrons will be paired with another electron.

Overall, the periodic table can be used as a guide for determining the number of valence electrons for each element (Fig 4.3).

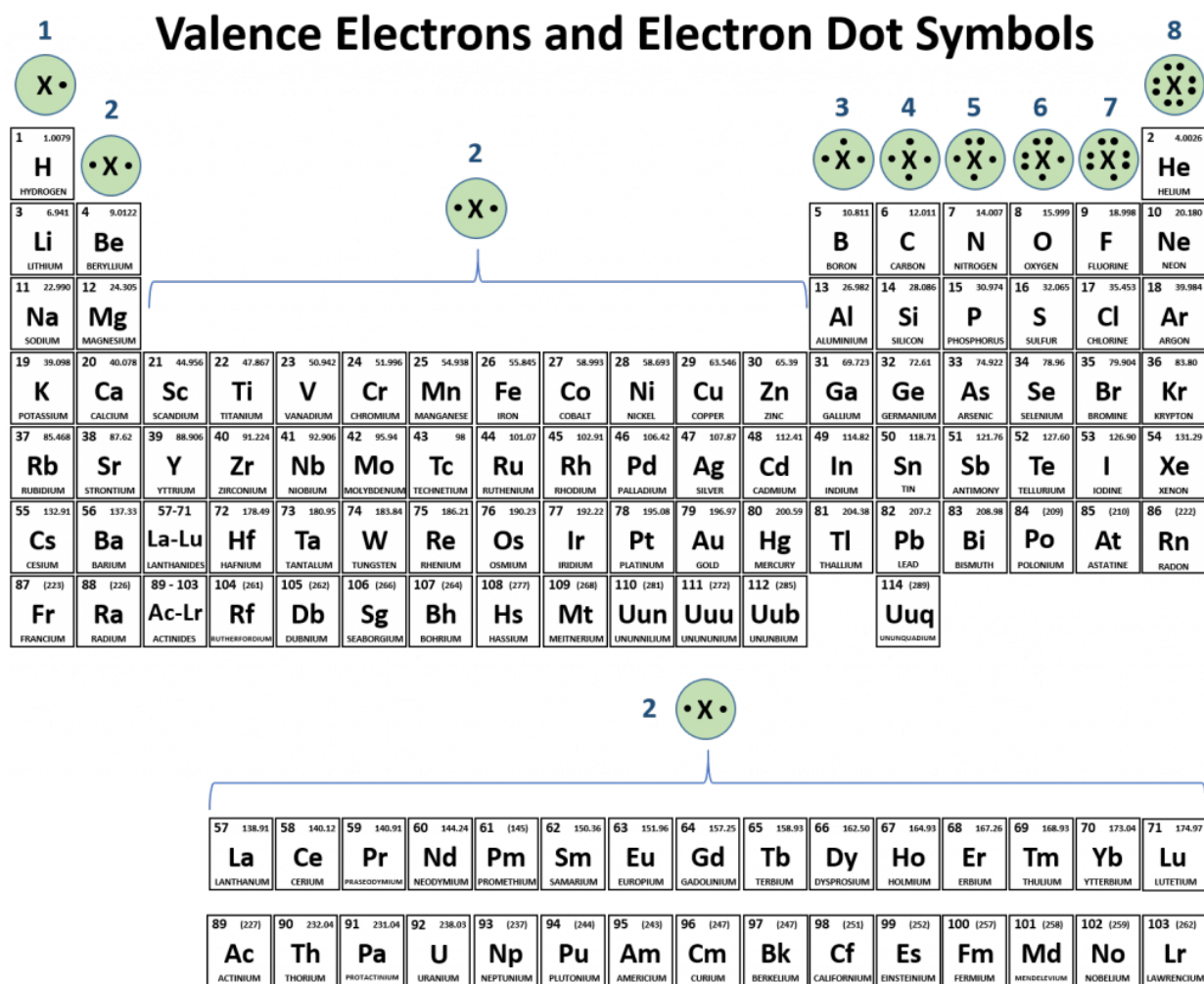

Figure 4.3 Periodic Table with Electron Dot Symbols. Electron dot symbols are drawn above each family or group of elements on the periodic table, where X indicates any element within that family or group.

Section 4.2: Ions and the Periodic Table

The elements on the right side of the periodic table, nonmetals, gain the electrons necessary to reach the stable electron configuration of the nearest noble gas. Elements on the left side of the periodic table, metals, lose the electrons necessary to reach the

electron configuration of the nearest noble gas. Transition elements can vary in how they move toward lower energy configurations.

Common Cations

Group IA elements form ions with a +1 charge. They lose one electron upon ionization, moving into the electron configuration of the previous noble gas. For example as shown in Figure 4.4, when a sodium (Na) atom is ionized, it loses one of its 11 electrons, becoming a sodium ion (Na^+) with the electron configuration that looks like the previous noble gas, neon. The sodium ion has one fewer electron than it has protons, so it has a single positive charge and is called a cation.

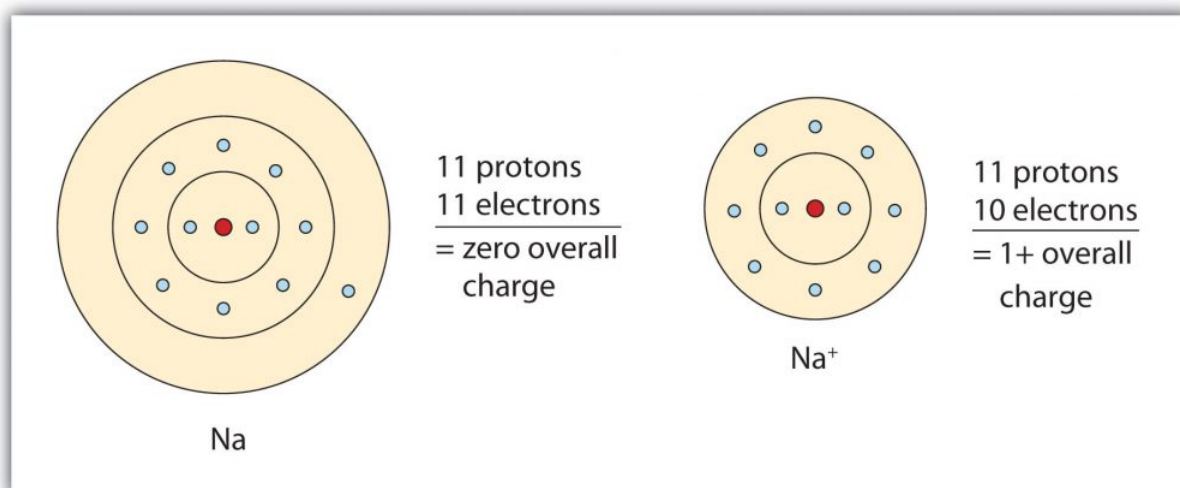

Figure 4.4 The Formation of a Sodium Ion. Sodium tends to lose its valence shell electron in the third shell during ionic bond formation. It is left with a full octet in the second shell and now has the electron configuration of neon. Note that it still has the same number of protons (11) as the original sodium atom and retains the identity of sodium. However, there are now only 10 electrons within the electron cloud, resulting in a net positive (+1) charge.

Upon losing that electron, the sodium ion now has an octet of electrons from the second principal energy level. The electron configuration of the sodium ion is now the same as that of the noble gas neon. The term **isoelectronic** refers to an atom and an ion of a different atom (or two different ions) that have the same electron configuration. The sodium ion is isoelectronic with the neon atom.

Overall, Group IA elements will lose one electron to reach the electron state of the noble gas preceding them in the periodic table. Note that the nucleus of the atom remains unchanged and thus, the identity of the ion is also unchanged. A sodium ion has the same electron configuration as neon, but not the same proton/neutron configuration. Thus, it retains its identity as the element, sodium even when it has undergone the loss of an electron. Similarly, Group IIA elements lose two valence electrons to form ions with a +2 charge and Group IIIA elements lose three electrons to form ions with a +3 charge. This gives them the electron configuration of the noble gas that comes before them in the periodic table.

While hydrogen is in the first column, it is not considered to be an alkali metal, and so it does not fall under the same classification as the elements below it in the periodic table. This is because hydrogen is very small and can only house a total of 2 electrons to become filled. It is an exception to the Octet Rule. Thus, instead of following the octet rule, it reaches greater stability by gaining a "duet" of electrons through bonding with other atoms. Thus, hydrogen can form both covalent bonds and ionic bonds, depending on the element that it is interacting with. When it participates in ionic bonds, it most often will lose its electron forming a +1 cation. Note, that hydrogen only has one electron to begin with, so when it loses an electron in the ionized state, there is only a single proton left in the nucleus of the atom. Thus, when hydrogen is ionized to H^+ it is often referred to as a **proton**. It can also be ionized, forming a -1 anion. In this case, the H^- anion is named using standard convention forming the **hydride ion**. During the ionization of hydrogen, the H^+ state is more common than the H^- state. In addition, the H^+ ion is very important in the chemistry of acids. Acids are defined as compounds that donate H^+ ions in aqueous solutions.

Cations are named very simply by following the element name with the word 'ion'. Thus, a sodium atom that has lost electrons, is now referred to as a sodium ion.

Note

Despite our focus on the octet rule, we must remember that for small atoms, such as hydrogen, helium, and lithium, the first shell is, or becomes, the outermost shell and hold only two electrons. Therefore, these atoms satisfy a “duet rule” rather than the octet rule.

Example 1: The Sodium Ion

A sodium atom has one valence electron. Do you think it is more likely for a sodium atom to lose one electron or gain seven electrons to obtain an octet?

Solution:

Although either event is possible, a sodium atom is more likely to lose its single valence electron. When that happens, it becomes an ion with a net positive charge. This can be illustrated as follows:

Sodium Atom		Sodium Ion	
11 protons	11+	11 protons	11+
11 electrons	11-	10 electrons	10-
	Overall Charge = 0		Overall Charge = +1

Common Anions

Elements on the other side of the periodic table, the nonmetals, tend to gain electrons in order to reach the stable electron configurations of the noble gases that come after them in the periodic table.

Group VIIA elements gain one electron when ionized, obtaining a -1 charge. For example as shown in Figure 4.5, chlorine (Cl), when ionized, gains an electron to reach the electron configuration of the noble gas that follows it in the periodic table, argon. This gives it a

single negative charge, and it is now a chloride ion (Cl^-); note the slight change in the suffix (-ide instead of -ine) to create the name of this anion.

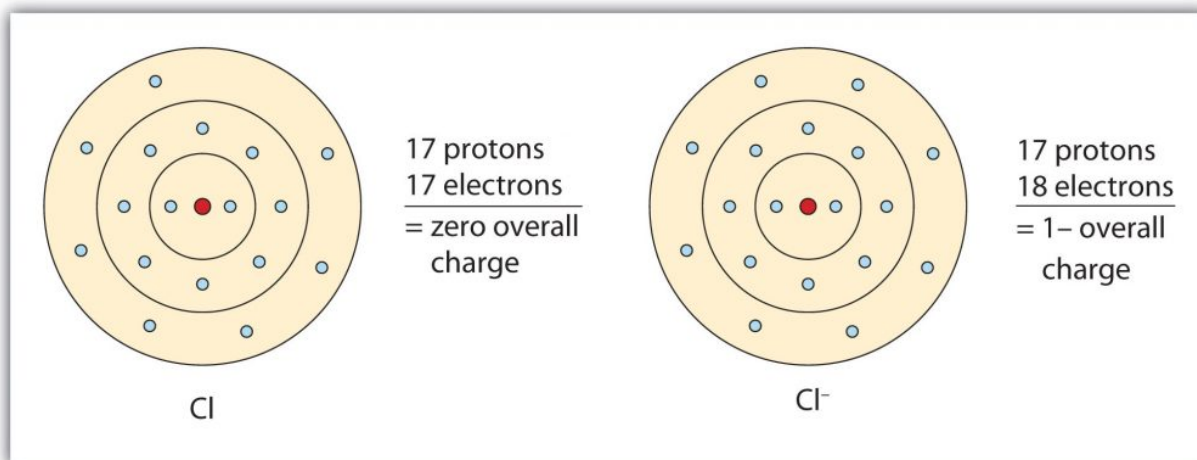

Fig 4.5 The Formation of a Chloride Ion. On the left, a chlorine atom has 17 electrons. On the right, the chloride ion has gained an extra electron for a total of 18 electrons and a 1^- charge. Note that the chloride ion has now filled its outer shell and contains eight electrons, satisfying the octet rule.

Group VIA elements gain two electrons upon ionization, obtaining -2 charges and reaching the electron configurations of the noble gases that follow them in the periodic table. Whereas, Group VA elements gain three electrons, obtaining -3 charges and also reaching the electron configurations of the noble gases that follow in the periodic table.

It is important not to misinterpret the concept of being isoelectronic. A sodium ion is very different from a neon atom because the nuclei of the two contain different numbers of protons. One is an essential ion that is a part of table salt, while the other is an unreactive gas that is a very small part of the atmosphere. Likewise, sodium ions are very different than magnesium ions, fluoride ions, and all the other members of the neon isoelectronic series ($\text{N}^{3-}, \text{O}^{2-}, \text{F}^-, \text{Ne}, \text{Na}^+, \text{Mg}^{2+}, \text{Al}^{3+}$)



Figure 4.6: Isoelectric Atoms Have Different Properties. Neon gas (A) and sodium chloride crystals (B). Neon atoms and sodium ions are isoelectronic. Neon is a colorless and unreactive gas that glows a distinctive red-orange color in a gas discharge tube. Sodium ions are commonly found in crystals of salt such as sodium chloride, ordinary table salt.

Key Takeaways:

- Cations form when an atom loses one or more electrons.
- The resulting cation has the electron configuration of the noble gas atom in the row above it in the periodic table.
- Anions form when an atom gains one or more electrons
- The resulting anion has the electron configuration of the noble gas atom in the same row of the periodic table

Ions of Transition and Inner Transition Metals

The transition and inner transition metals are an interesting and challenging group of elements. They have perplexing patterns of electron distribution that don't always follow the electron filling rules. Predicting how they will form ions is also not always obvious. Thus, you should refer to the common ion periodic table to determine the ionic states of transition and inner transition elements (Figure 4.7).

Common Ionic States of the Elements

+1	Common Ionic States of the Elements																+2
1 H⁺ <small>HYDROGEN</small>																	2 He <small>HELIUM</small>
3 Li⁺ <small>LITHIUM</small>	Atomic number →																10 Ne <small>NEON</small>
4 Be²⁺ <small>BERYLLIUM</small>	← Common ionic state																11 Na⁺ <small>SODIUM</small>
																	12 Mg²⁺ <small>MAGNESIUM</small>
																	13 Al³⁺ <small>ALUMINIUM</small>
																	14 Si <small>SILICON</small>
																	15 P³⁻ <small>PHOSPHORUS</small>
																	16 S²⁻ <small>SULFUR</small>
																	17 Cl⁻ <small>CHLORINE</small>
																	18 Ar <small>ARGON</small>
19 K⁺ <small>POTASSIUM</small>	20 Ca²⁺ <small>CALCIUM</small>	21 Sc³⁺ <small>SCANDIUM</small>	22 Ti³⁺ Ti⁴⁺ <small>TITANIUM</small>	23 V³⁺ V⁵⁺ <small>VANADIUM</small>	24 Cr²⁺ Cr³⁺ <small>CHROMIUM</small>	25 Mn²⁺ Mn⁴⁺ <small>MANGANESE</small>	26 Fe²⁺ Fe³⁺ <small>IRON</small>	27 Co²⁺ Co³⁺ <small>COBALT</small>	28 Ni²⁺ Ni³⁺ <small>NICKEL</small>	29 Cu⁺ Cu²⁺ <small>COPPER</small>	30 Zn²⁺ <small>ZINC</small>	31 Ga³⁺ <small>GALLIUM</small>	32 Ge⁴⁺ <small>GERMANIUM</small>	33 As³⁻ <small>ARSENIC</small>	34 Se²⁻ <small>SELENIUM</small>	35 Br⁻ <small>BROMINE</small>	36 Kr <small>KRYPTON</small>
37 Rb⁺ <small>RUBIDIUM</small>	38 Sr²⁺ <small>STRONTIUM</small>	39 Y³⁺ <small>YTTORIUM</small>	40 Zr⁴⁺ <small>ZIRCONIUM</small>	41 Nb³⁺ Nb⁵⁺ <small>NIOBIUM</small>	42 Mo⁶⁺ <small>MOLYBDENUM</small>	43 Tc⁷⁺ <small>TECHNETIUM</small>	44 Ru³⁺ Ru⁴⁺ <small>RUTHENIUM</small>	45 Rh³⁺ <small>RHODIUM</small>	46 Pd²⁺ Pd⁴⁺ <small>PALLADIUM</small>	47 Ag⁺ <small>SILVER</small>	48 Cd²⁺ <small>CADMIUM</small>	49 In³⁺ <small>INDIUM</small>	50 Sn²⁺ Sn⁴⁺ <small>TIN</small>	51 Sb³⁺ Sb⁵⁺ <small>ANTIMONY</small>	52 Te²⁻ <small>TELLURIUM</small>	53 I⁻ <small>IODINE</small>	54 Xe <small>XENON</small>
55 Cs⁺ <small>CAESIUM</small>	56 Ba²⁺ <small>BARIUM</small>	71 Lu³⁺ <small>LUTETIUM</small>	72 Hf⁴⁺ <small>HAFNIUM</small>	73 Ta⁵⁺ <small>TANTALUM</small>	74 W⁶⁺ <small>TUNGSTEN</small>	75 Re⁷⁺ <small>RHENIUM</small>	76 Os⁴⁺ <small>OSMIUM</small>	77 Ir⁴⁺ <small>IRIDIUM</small>	78 Pt²⁺ Pt⁴⁺ <small>PLATINUM</small>	79 Au⁺ Au³⁺ <small>GOLD</small>	80 Hg₂²⁺ Hg²⁺ <small>MERCURY</small>	81 Tl⁺ <small>THALLIUM</small>	82 Pb²⁺ Pb⁴⁺ <small>LEAD</small>	83 Bi³⁺ Bi⁵⁺ <small>BISMUTH</small>	84 Po²⁺ <small>POLONIUM</small>	85 At⁻ <small>ASTATINE</small>	86 Rn <small>RADON</small>
87 Fr⁺ <small>FRANCIUM</small>	88 Ra²⁺ <small>RADIUM</small>	103 Lr³⁺ <small>LAWRENCIUM</small>	57 La³⁺ <small>LANTHANUM</small>	58 Ce³⁺ <small>CERIUM</small>	59 Pr³⁺ <small>PRASEODYMIUM</small>	60 Nd³⁺ <small>NEODYMIUM</small>	61 Pm³⁺ <small>PROMETHIUM</small>	62 Sm²⁺ Sm³⁺ <small>SAMARIUM</small>	63 Eu²⁺ Eu³⁺ <small>EUROPIUM</small>	64 Gd³⁺ <small>GADOLINIUM</small>	65 Tb³⁺ <small>TERBIUM</small>	66 Dy³⁺ <small>DYSPROSIUM</small>	67 Ho³⁺ <small>HOLMIUM</small>	68 Er³⁺ <small>ERBIUM</small>	69 Tm³⁺ <small>THULIUM</small>	70 Yb³⁺ <small>YTTERIUM</small>	
			89 Ac³⁺ <small>ACTINIUM</small>	90 Th⁴⁺ <small>THORIUM</small>	91 Pa⁴⁺ Pa⁵⁺ <small>PROTACTINIUM</small>	92 U⁴⁺ U⁶⁺ <small>URANIUM</small>	93 Np⁵⁺ <small>NEPTUNIUM</small>	94 Pu⁴⁺ Pu⁴⁺ <small>PLUTONIUM</small>	95 Am³⁺ Am⁴⁺ <small>AMERICIUM</small>	96 Cm³⁺ <small>CURIUM</small>	97 Bk³⁺ <small>BERKELIUM</small>	98 Cf³⁺ <small>CALIFORNIUM</small>	99 Es³⁺ <small>EINSTEINIUM</small>	100 Fm³⁺ <small>FERMIUM</small>	101 Md²⁺ Md³⁺ <small>MENDELEVIUM</small>	102 No²⁺ No³⁺ <small>NOBELIUM</small>	

Figure 4.7 Common Ionic States of the Elements. For elements that have more than one common ionic state, both states are listed. Note that when mercury carries a +1 charge, it forms an uncommon polyatomic ionic state, Hg_2^{2+} where two Hg atoms share electrons and then each also has a +1 charge state (see section XX for more details about polyatomic ions and Hg_2^{2+}). For the printable PDF version of this table (with the common polyatomic ions), click the link below:

[Periodic Table with Ions](#)

Section 4.3: Ionic Bonding

Most of the rocks and minerals that make up the Earth's crust are composed of positive and negative ions held together by ionic bonding. An ionic compound is an electrically neutral compound consisting of positive and negative ions. You are very familiar with some ionic compounds such as sodium chloride (NaCl). A sodium chloride crystal consists of equal numbers of positive sodium ions (Na⁺) and negative chloride ions (Cl⁻).

Anions and cations have opposing charges. Because of this, they are attracted to one another. When an anion and a cation are drawn together due to this electrostatic attraction, they can form an **ionic bond**. This kind of bond is the result of opposing charges attracting one another, and is distinct from other types of bonding. Two or more ions bound by electrostatic attraction make an **ionic compound**. The simplest ionic compounds are binary ionic compounds or those that only contain two atoms, one acting as the cation, and one acting as the anion. Thus, we will focus on the formation of binary ionic compounds first.

Sodium chloride, or table salt, is an ionic compound. Let's take a look at how it is formed. During the formation of sodium chloride, the electron given off by sodium is taken by chlorine, forming the chloride ion. The chloride ion has one excess electron, giving it a -1 charge. The result of this electron transfer is that the sodium cation and chloride anion become bound through electrostatic attraction, forming sodium chloride, an ionic compound. Note that, electrons cannot be simply "lost" to nowhere in particular, they always end up going to another atom or molecule. Ionic reactions can be represented by electron dot diagrams, as shown below for sodium chloride.

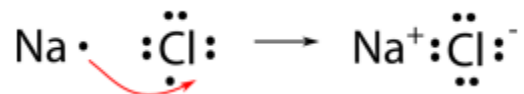

The ionic bond is the attraction of the Na⁺ ion for the Cl⁻ ion. It is conventional to show the cation without dots around the symbol to emphasize that the original energy level that contained the valence electron is now empty. The anion is now shown with a complete octet of electrons. The final formula for sodium chloride is NaCl. Notice that both ions are represented but their charges are not shown. This is because within ionic compounds the overall charge on the compound is zero, i.e. the charge states of the cation(s) and the anion(s) involved in the bond need to be paired in such a way that the number of positive charges equals the number of negative charges. For sodium chloride this is an easy task as one chloride ion has a -1 charge and one sodium ion has a positive

charge +1, cancelling each other to zero. Also note that in chemical formulas that the cation always comes first and the anion is always placed second in the formula.

For a compound such as magnesium chloride, it is not quite as simple. Because magnesium has two valence electrons, it needs to lose both to achieve the noble-gas configuration. Therefore, two chlorine atoms will be needed.

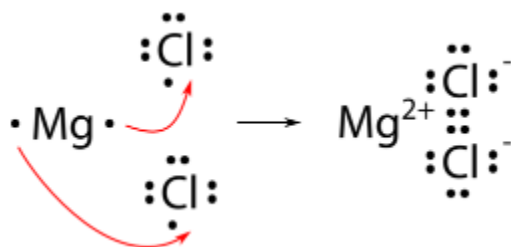

The final formula for magnesium chloride is MgCl₂. Note that the subscript (2) next to the chloride ion, indicates that there are two chloride ions paired with each magnesium cation. When there is only one ion present in a formula, (i.e the magnesium ion in this case), the subscript of one is implied instead of shown in the formula. As in the case of NaCl, there are no charges shown in the final formula of MgCl₂. This is because the positive charge of the magnesium ion (+2) is balanced by the negative charge of the two chloride ions [2 X (-1) = -2] giving the overall molecule a net charge of zero.

Key Takeaways:

- An ionic compound contains positive and negative ions.
- An ionic bond is electrostatic in nature.
- Electron dot diagrams can be used to illustrate electron movements and ion formation.
- Stable ionic compounds have a balanced charge state such that the charge on the overall molecule is zero.

Section 4.4: Practice Writing Correct Ionic Formulas

To predict and write correct chemical formulas, the key fundamental steps that are required, are (1) knowing the charge states of the ions and (2) using basic math to help you determine how many cations and anions are needed to reach a zero charge state, (3) writing the chemical formulas with the cation first followed by the anion, and (4) writing the formula with the lowest ratio of cations and anions to create a net neutral compound.

Overall, ionic bonding occurs between a cation (electron donor) and an anion (electron acceptor) to form a compound that has an overall neutral net charge. Of note, ionic bonds usually occur between a metal and a nonmetal. This will help you recognize ionic compounds more easily, once we learn about covalent bonding (which occurs most commonly between two nonmetals, or between a nonmetal and a semimetal (metalloid)).

So, say we want to write the correct chemical formula for a molecule that contains Fe^{3+} as the cation, and Cl^- as the anion. What is the correct ionic formula?

To begin this type of problem, I recommend drawing out a charge box or a charge table to help you keep track of the number of ions used, the charges of those ions, and the overall positive and negative charges on the molecule. Drawing out the electron dot symbols can also be helpful. Here is an example of a generic charge box

	CATION	ANION	
CHARGE of ION			
# ATOMS			Total Charge (on the Molecule)
TOTAL ION CHARGE			

Let's try it out for our example of Fe^{3+} and Cl^- . First, let's fill in what we know about each element and its ionic state:

	Fe	Cl	
CHARGE of ION	+3	-1	
# ATOMS			Total Charge (on the Molecule)
TOTAL ION CHARGE			

So now we have our charge box set up with our known information. Now we need to figure out how many atoms of the cation and the anion are required to cancel out the overall positive and negative charge on the resulting molecule. To do this, it is often useful to use the cross-multiplication strategy, where you try using the charge number for the cations, as the number of atoms of anion required, and the charge number for the anion as the number of atoms of the cation required. Multiply each of the ion charges by the number of atoms to calculate the total ion charges of the cation(s) and anion(s) present and then add these numbers together to find the total charge on the compound. This will usually get you to the stable ionic formula that has a net neutral charge of zero.

	Fe	Cl	
CHARGE of ION	+3	-1	
# ATOMS	1	3	Total Charge (on the Molecule)
TOTAL ION CHARGE	+3	-3	= 0

The # of atoms column then becomes the subscripts that you need to use to construct the correct ionic formula. In this case 1 atom of iron (Fe) with 3 atoms of chlorine (Cl) for a formula of **FeCl₃**.

The previous example is pretty straight forward, and you may have been able to construct the formula in you head. However, as the complexity of formula making increases, it is good to be able to use the charge box method to double check your work. For example,

what would the correct ionic formula be for aluminum sulfide? First, identify the two atoms involved (Aluminum and Sulfur) and start building your charge box with what you know from the periodic table. From the periodic table in Figure 4.7, you can see that aluminum forms a cation with a +3 charge whereas sulfur forms an anion with a -2 charge state.

	Al	S	
CHARGE of ION	+3	-2	
# ATOMS	2	3	Total Charge (on the Molecule)
TOTAL ION CHARGE	+6	-6	= 0

For step 1: Add in the correct charge for the cation and anion in question, in this case +3 for Al and -2 for S. For Step 2: Use the cross multiply rule to predict how many atoms will be needed from each type and multiply through the total ion charge for both the cation and anion. For Step 3: Add the products together to be sure that your compound is stable and the net charge on the formula is zero. Step 4: Use the # Atoms value to create the subscripts for your chemical formula. In our example, we require 2 atoms of Al and 3 atoms of S. This would be written as **Al₂S₃** as the final product.

Key Takeaways:

- When writing chemical formulas, the cation is always first and the anion is always last.
- Stable chemical formulas must be written so that the overall compound has a net neutral charge (ie the total positive charge = the total negative charge).
- Subscripts are used to show how many atoms are present within an ionic formula

Section 4.5: Naming Ions and Ionic Compounds

Some compounds have common names, like *water* for H₂O. However, there are thousands of other compounds that are uncommon or have multiple names. Also, the common name is usually not recognized internationally. What looks like *water* to you might look like *agua* or *vatten* to someone else. To allow chemists to communicate without confusion, there are naming conventions to determine the systematic name of a chemical. For the chemistry naming system in this text, we will primarily be using the International Union of Pure and Applied Chemistry (IUPAC) naming system. Note that there is also an older and more archaic (-ous and -ic) naming system, in addition to the IUPAC system. In some instances the older naming system is still in high use. These deviations from the IUPAC system will be noted throughout the text, as you will likely still see this older nomenclature still in use within chemical laboratories and the health sciences field.

The convention for naming cations is very easy. It is simply to take the element name and add the term 'ion' to the end of it. So if we are referring to a sodium atom that has lost one electron (Na⁺), we would use the term sodium ion. This indicates that sodium is in the +1 charge state, rather than the elemental form of sodium (which has an equal number of protons and electrons and is neutral in charge). Using the ion naming system when referring to ions, rather than the elemental names of atoms is important, as the reactivity of the ion vs the elemental form of a substance can be quite different. For example, if you add the sodium ion to your glass of drinking water in the form of NaCl (or table salt), you will have a nice salty drink on your hands. On the other hand, if you add the elemental form of sodium to your glass of drinking water, it will explode in your face, as the elemental form of sodium is very reactive with water!

For cations that have more than one charge state the name of the atom is followed by a roman numeral and then the term ion, to distinguish the different ionic states. For example, iron has two predominant ionic forms, Fe²⁺ and Fe³⁺. Thus, in naming these two ions, we would refer to the first one as the iron (II) ion, and the second as the iron (III) ion. This way, there is no confusion about which ion is being referred to when discussing a compound.

Naming anions is a little more complicated. The ending of the element is typically dropped and replaced with the 'ide' ending followed by the term ion. For example, Cl⁻ is referred to as the chloride ion, rather than the chlorine ion. In this case, the '-ine' ending of chlorine is dropped and replaced with the 'ide' ending. For sulfur, the '-ur' ending is dropped and replaced with 'ide' to form the sulfide ion. Similarly phosphorus is converted to the phosphide ion, nitrogen to the nitride ion, and oxygen to the oxide ion. The '-ide'

ending is useful because it helps the listener distinguish very quickly between the different types of ions being discussed (the cation which retains the element name vs. the anion which changes the elemental name to the '-ide' ending).

When naming ionic compounds the term ion is dropped and the cation and anion names are placed together, with the cation always listed first and the anion listed last. If the elements involved in the ionic bond only have one possible ionic state, no roman numerals are needed in the name. For example, when the Na^+ and the Cl^- come together to make NaCl , the resulting compound is called sodium chloride. Similarly, if Mg^{2+} and Cl^- come together to make MgCl_2 , the resulting compound is called magnesium chloride. However, if the elements involved in the ionic bond have more than one possible ionic state, the roman numeral system is used to clarify which ion is participating in the bond. For example, if Fe^{3+} and Cl^- come together to form FeCl_3 , we will need to distinguish it from Fe^{2+} coming together with Cl^- to form FeCl_2 in the name so that everyone will understand which ion of iron is being referred to in the reaction. In this case, the first compound will be called iron (III) chloride, and the second compound is iron (II) chloride.

The key feature about naming ionic compounds is that you should be able to draw the structure from the name, and that you should be able to create the name from the structure. Let's do some practice!

Section 4.6: Polyatomic Ions

Up until now, we have been looking at compounds involving monoatomic ions, or ions that occur with a single atom. However, many commonly found ions are composed of multiple atoms that are bound to one another through the sharing of electrons, or covalently. These ions behave as a single unit, bearing a charge and interacting with other ions and compounds just like the monatomic ions discussed above. Because these ions are made of multiple atoms, they are called **polyatomic ions**. It is more common for polyatomic ions to be negatively charged than to be positively charged. Below is a chart showing some commonly encountered polyatomic ions.

Table 4.1 Common Polyatomic Ions

NEGATIVE POLYATOMIC IONS		chlorate	ClO_3^-	hydrogen oxalate	HC_2O_4^-
acetate	CH_3COO^- or $\text{C}_2\text{H}_3\text{O}_2^-$	chlorite	ClO_2^-	hydrogen sulfate	HSO_4^-
arsenate	AsO_4^{3-}	chromate	CrO_4^{2-}	hydrogen sulfide	HS^-
arsenite	AsO_3^{3-}	cyanate	CNO^-	hydrogen sulfite	HSO_3^-
benzoate	$\text{C}_6\text{H}_5\text{COO}^-$	cyanide	CN^-	hydroxide	OH^-
borate	BO_3^{3-}	dichromate	$\text{Cr}_2\text{O}_7^{2-}$	hypochlorite	ClO^-
bromate	BrO_3^-	dihydrogen phosphate	H_2PO_4^-	iodate	IO_3^-
carbonate	CO_3^{2-}	hydrogen carbonate (also bicarbonate)	HCO_3^-	monohydrogen phosphate	HPO_4^{2-}

nitrate	NO_3^-	pyrophosphate	$\text{P}_2\text{O}_7^{4-}$
nitrite	NO_2^-	sulfate	SO_4^{2-}
orthosilicate	SiO_4^{4-}	sulfite	SO_3^{2-}
oxalate	$\text{C}_2\text{O}_4^{2-}$	thiocyanate	SCN^-
perchlorate	ClO_4^-	thiosulfate	$\text{S}_2\text{O}_3^{2-}$
periodate	IO_4^-	POSTITIVE POLYATOMIC IONS	
permanganate	MnO_4^-	ammonium	NH_4^+
peroxide	O_2^{2-}	hydronium	H_3O^+
phosphate	PO_4^{3-}	mercury I	Hg_2^{2+}

Polyatomic ions can be thought of in a very similar way to monoatomic ions, in that they are ionized by either gaining or losing electrons so that they carry a charge. If they gain electrons, they will become an anion and carry a negative charge, and if they lose electrons, they will become a cation and carry a positive charge. The charge of a polyatomic ion is represented as a superscript that is placed at the upper righthand edge of the ion. For example, for the phosphate ion, the chemical formula is PO_4^{3-} . This indicates that the overall -3 charge is distributed to the entire PO_4 molecule, and that when it is involved in forming an ionic compound, the entire PO_4^{3-} ion moves as and is treated as a single unit. Let's try making a few compounds using phosphate as an example. First let's build a molecule of sodium phosphate. Note that when you are asked to build molecules from their name, you can often recognize when you have a polyatomic ion due to the name. Recall that monoatomic anions end in the suffix '-ide'. Thus, when you see a different suffix ending, such as '-ate' or '-ite', this should indicate that you are

dealing with a polyatomic ion and you should refer to the table above to help you discern the correct ion formula to use. For the sodium phosphate example, we can build this molecule using the same charge box diagram that we used above to construct the simpler biatomic structures above. First we need to place the ions and their charge states into the table. In this case, we know that sodium is a cation with a +1 charge and the phosphate ion is an anion with a -3 charge.

	Na	PO₄	
CHARGE of ION	+1	-3	
# ATOMS			Total Charge (on the Molecule)
TOTAL ION CHARGE			

Note that in our table, we are treating the polyatomic ion as a single unit. We can then continue to use our cross multiplication strategy to determine how many cations and anions are needed to create an overall molecule that is neutral in charge.

	Na	PO₄	
CHARGE of ION	+1	-3	
# ATOMS	3	1	Total Charge (on the Molecule)
TOTAL ION CHARGE	+3	-3	= 0

Thus, we will need 3 atoms of sodium and one molecule of phosphate to complete our structure. Overall the chemical formula of sodium phosphate is written as Na₃PO₄. Note that the naming of the resulting molecule is done in exactly the same way as with other ionic compounds. The name of the cation comes first (using roman numerals when necessary) followed by the name of the anion (in this case phosphate).

How about a more complicated example? How would we make a molecule of magnesium phosphate? Start building your molecule using the charge box diagram, noting this time that magnesium forms an Mg^{2+} ion.

	Mg	PO ₄	
CHARGE of ION	+2	-3	
# ATOMS	3	2	Total Charge (on the Molecule)
TOTAL ION CHARGE	+6	-6	= 0

Setting up the charge box for this compound is not more difficult than any other compound. However, one must be careful when writing out compounds that require more than one polyatomic ion within the chemical formula. In this case we need 2 phosphate ions to combine with 3 magnesium ions to form magnesium phosphate. The cation in this case is written the same, however, parentheses are needed when expressing the 2 phosphate ions, as follows:

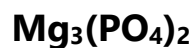

The parentheses around the phosphate ion ensure that it is clear that you need two entire PO_4^{3-} ions within this complex. A structural diagram of what this molecule would look like is shown below. Note that each straight line is being used here to indicate a covalent bond within the phosphate ion. Each straight line represents two electrons (or an electron pair) that is being shared between the atoms. Covalent bonding will be described in more detail in chapter 4. For now, it is important to remember that the polyatomic ions move together as a single unit because the atoms that are sharing electrons must stay in close proximity with one another. The ionic bonds are indicated with the (+) and (-) symbols. For magnesium phosphate there are a total of 6 ionic bonds that are formed.

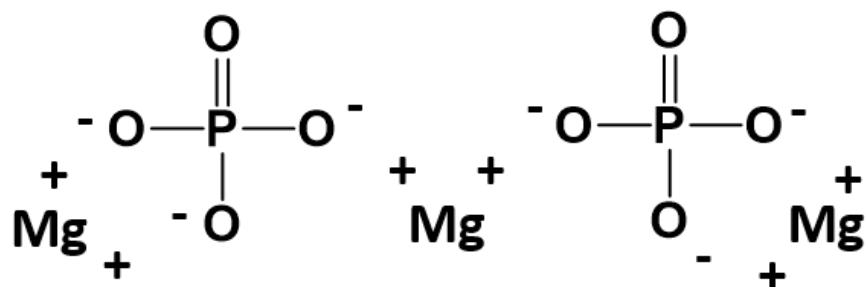

Another strange example is mercury (I) chloride. This one is an exception to our normal bonding rules. You would predict based on charge possibilities that mercury (I) chloride should have the chemical formula of HgCl, as the chloride ion has a charge of -1, and mercury (I) is indicated to have a charge of +1. However, in this unique case, this formula is incorrect. Mercury is unusual in that its singly ionized oxidation state, mercury(I), is found as a dimeric cation, Hg_2^{2+} , where two atoms of mercury are actually covalently bonded to one another as a polyatomic ion. Each mercury atom within the bonded pair has a charge state of +1. This give the overall ion a +2 state, as shown below:

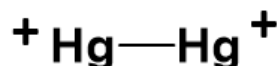

Mercury (I) Ion

Unfortunately, this polyatomic ion does not have a unique name that distinguishes it from normal monoatomic cations. Thus, you will need to remember this unique member. The final mercury (I) chloride chemical formula needs 2 chloride ions to complete the structure, for a minimal chemical formula of Hg_2Cl_2 .

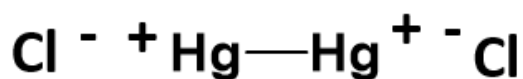

Mercury (I) Chloride

While mercury (I) chloride is rarely found in nature, during the 18th and 19th centuries, known as calomel, it was commonly used as medicine to treat infectious diseases like syphilis and yellow fever. It was also used as a general tonic to make patients regurgitate

and release their body from 'impurities'. Calomel had extreme side effects and toxicity during its medical use causing both loss of hair and teeth. In fact, calomel was also a common ingredient in teething powders in Britain up until 1954, causing widespread mercury poisoning in the form of pink disease, which at the time had a mortality rate of 1 in 10. Once the cause of pink disease was linked with mercury toxicity, the substance was removed from these powders. In the United States, its use faded in the late 1800's with the discovery of more effective treatments, such as the discovery of penicillin in the late 19th century by Alexander Flemming.

Abraham Lincoln and “Blue Mass”

“Blue mass,” a medication that consisted of elemental mercury with various additives, was commonly used for all kinds of complaints in the Civil War-era United States. Though mercury was a known toxin, it was a prominent feature in medical treatment for “hypochondriasis,” a condition that may have included various problems we now understand as mood disorders, along with digestive system issues. Abraham Lincoln was known to exhibit the symptoms of hypochondriasis, and he took the blue mass medication. Interestingly, he was known by friends and acquaintances to suffer from insomnia and erratic mood, and there is some evidence that he displayed additional neurological abnormalities. These are symptoms of mercury poisoning. Within the body, elemental mercury, which is uncharged, is oxidized to its mercuric form (Hg^{2+}), which has a +2 charge. This form of mercury is devastating to many body systems, causing dysfunction that may have been responsible for Abraham Lincoln’s symptoms. His treatment may have been more harmful than the problems for which it was intended, due to medicine’s lack of understanding.

Section 4.7: Naming Polyatomic Ions

Polyatomic ions have special names as noted in Table 4.1. Many of them contain oxygen and are called **oxyanions**. When only one oxyanion for an element exists, the ending of the primary element is given the '-ate' ending. For example, the oxyanion of carbon is called carbonate (CO_3^{2-}). However, when different oxyanions exist using the same element but have a different number of oxygen atoms, prefixes and suffixes are used to tell them apart. For example, if two oxyanions exist, the one with the lower number of oxygens will be given the '-ite' ending and the one with more oxygens will be given the '-ate' ending. Oxyanions of nitrogen and sulfur are a good example:

NO_2^- is called Nitrite

NO_3^- is called Nitrate

SO_3^{2-} is called Sulfite

SO_4^{2-} is called Sulfate

Sometimes there may be three or four oxyanions. In this case, the prefix 'hypo-' will be used to indicate one less oxygen than '-ite' form. When four oxyanions exist there is also a 'per-' prefix, meaning one more oxygen than the '-ate' form. The chlorine family of ions is an excellent example where these prefixes are needed.

ClO^- is called hypochlorite

ClO_2^- is called chlorite

ClO_3^- is called chlorate

ClO_4^- is called perchlorate

Occasionally, you will see a *bi-* prefix. This is an older prefix, it means the compound can both take up and lose a proton (H^+). IUPAC nomenclature will use *hydrogen* in the name, whereas the older nomenclature uses the *bi-*prefix. In either case, the oxyanion will have a hydrogen in it, decreasing its charge by one. For instance, there is carbonate (CO_3^{2-}) and hydrogen carbonate (HCO_3^-). You may also see hydrogen carbonate referred to as bicarbonate.

One last prefix you may find is *thio-*. It means an oxygen has been replaced with a sulfur within the oxyanion. Cyanate is OCN^- , and thiocyanate is SCN^- .

Naming ionic compounds that contain polyatomic ions is done in exactly the same way as with other binary ionic compounds. The name of the cation comes first (using roman numerals when necessary) followed by the name of the anion. Refer to Table 4.1 to determine the correct names for the polyatomic ions.

Section 4.8: Properties and Types of Ionic Compounds

Ionic compounds are held together by the electrostatic forces created by the attraction of the positively charged cations and negatively charged anions. These can be simple ions such as the sodium (Na^+) and chloride (Cl^-) in sodium chloride, or polyatomic species such as the ammonium (NH_4^+) and carbonate (CO_3^{2-}) ions in ammonium carbonate. Individual ions within an ionic compound usually have multiple nearest neighbors, so are not considered to be part of individual molecules, but instead as part of a continuous three-dimensional network or lattice, usually in a crystalline structure. Figure 4.8 shows the structure of sodium chloride (NaCl)

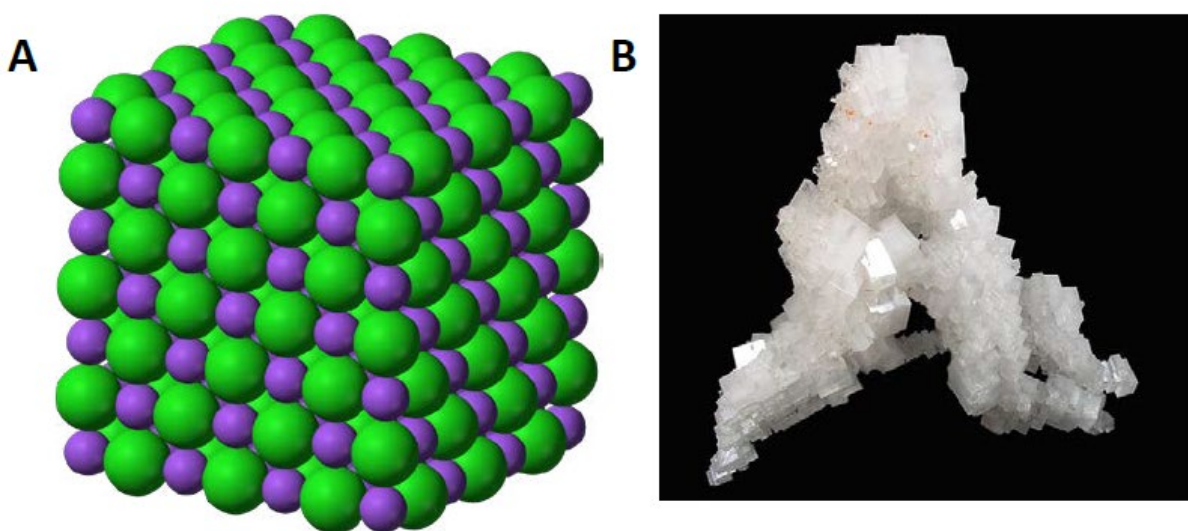

Figure 4.8 Crystal Lattice. (A) The crystal structure of sodium chloride, NaCl , a typical ionic compound. The purple spheres represent sodium cations, Na^+ , and the green spheres represent chloride anions, Cl^- . (B) Halite, the mineral form of sodium chloride, forms when salty water evaporates leaving the ions behind.

Source: (A) Benjah-bmm27 (2010). (B) Lavisky, R. (2010) Both (A) and (B) Available at: https://en.wikipedia.org/wiki/Ionic_compound

Ionic compounds containing hydrogen ions (H^+) are classified as acids, and those containing hydroxide (OH^-) or oxide (O^{2-}) ions are classified as bases. All other ionic compounds without these ions are known as salts. Ionic compounds typically have high melting and boiling points, and are hard and brittle. As solids, they are most

often electrically insulating, but when melted or dissolved they become highly conductive, because the ions are mobilized. When the ions are mobilized in solution, they are referred to as electrolytes, due to their ability to conduct electricity.

Section 4.9 Arrhenius Acids and Bases

H^+ and OH^- ions are the key players in acid-base chemistry, under the Arrhenius definitions for acids and bases. Arrhenius defined an acid as a compound that increases the concentration of hydrogen cations (H^+) in aqueous solution. Many acids are simple compounds that release a hydrogen cation into solution when they dissolve and can be recognized as ionic compounds that contain H^+ as the cation. Similarly, Arrhenius defined a base as a compound that increases the concentration of hydroxide ions (OH^-) in aqueous solution. Many bases are ionic compounds that have the hydroxide ion as their anion, which is released when the base dissolves in water.

Arrhenius bases are named according to standard ionic nomenclature, with the strongest bases being the hydroxides of the alkali metals and the heavier alkaline earth metals. You will be expected to recognize strong bases.

STRONG BASES	
Name	Structure
Group 1A metal hydroxides	$LiOH$, $NaOH$, KOH , $RbOH$, $CsOH$
Heavy Group 2A metal hydroxides	$Ca(OH)_2$, $Sr(OH)_2$, $Ba(OH)_2$

Arrhenius acids have a nomenclature system that is a little more complex, since their structures can include both binary compounds as well as polyatomic anions. In naming acids from binary compounds, the prefix 'hydro-' is used to represent the cation H^+ , and the suffix '-ic' acid is used to indicate that it is an acidic form. The element name of the anion can be used directly, as is the case for H_2S known as hydrosulfuric acid, or more commonly, the anion is modified by dropping the '-ine', '-ous' or '-ogen' ending before replacing with the suffix '-ic acid', as is the case for HCl which is known as hydrochloric acid, H_3P which is known as hydrophosphoric acid and H_3N which is known as hydronitric acid.

If an acid contains a polyatomic ion, no leading prefix is used to indicate the H^+ cation. This is implied within the name. For polyatomic anions ending with the suffix '-

ate', the acid is named as the [anion name] + the '-ic acid' suffix. For example, when the sulfate ion (SO_4^{2-}) is complexed with H^+ as the cation, the overall formula will be H_2SO_4 and the resulting acid will be named sulfuric acid. Dropping the prefix distinguishes polyatomic acids from the binary acids, in this case sulfuric acid (H_2SO_4) is distinguished from hydrosulfuric acid (H_2S). If a polyatomic anion has the '-ite' ending, the acid name will be written as the [anion name] + the '-ous acid' suffix. For example HNO_2 would be nitrous acid, and HNO_3 would be nitric acid. The prefixes 'hypo-' and 'per-' are also retained in the acid nomenclature for elements that have many oxyanion states. For example the chlorine containing oxyanions can form the following acids:

HClO = hypochlorous acid

HClO_2 = chlorous acid

HClO_3 = chloric acid

HClO_4 = perchloric acid

These are all distinguished from the binary chlorine-containing acid:

HCl = hydrochloric acid

Strong acids are ones that completely dissociate into their ionic forms in solution. The following table lists common strong acids that you will need to be familiar with.

STRONG ACIDS	
Name	Structure
Perchloric Acid	HClO_4
Chloric Acid	HClO_3
Hydrochloric Acid	HCl
Hydrobromic Acid	HBr
Hydroiodic Acid	HI
Nitric Acid	HNO_3
Sulfuric Acid	H_2SO_4

Section 4.10: Ions, Neurons and Actions Potentials

Within biological systems, ions play many important roles including muscle contraction, cellular metabolism, and ATP energy production, but perhaps one of the most important roles is in the function of the brain. The brain is an extremely complex organ that is composed of trillions of tiny cells called **neurons**. A **neuron**, also known as a **nerve cell**, is an electrically excitable cell that receives, processes, and transmits information through electrical and chemical signals. These signals between neurons occur via specialized connections called synapses. Neurons can connect to each other to form neural pathways, and neural circuits that can be quite complicated. Neurons are the primary components of the central nervous system, which includes the brain and spinal cord, and of the peripheral nervous system, which comprises the autonomic nervous system and the somatic nervous system.

There are many types of specialized neurons that can be classified by shape, location, or function (Fig. 4.9). Sensory neurons respond to one particular type of stimulus such as touch, sound, or light and all other stimuli affecting the cells of the sensory organs, and converts it into an electrical signal via transduction, which is then sent to the spinal cord or brain. Motor neurons receive signals from the brain and spinal cord to control everything from muscle contractions to glandular output. Interneurons connect neurons to other neurons within the same region of the brain or spinal cord in neural networks.

A typical neuron consists of a cell body (soma), dendrites, and an axon (Fig 4.10) The term neurite is used to describe either a dendrite or an axon, particularly in its undifferentiated stage. Dendrites are thin structures that arise from the cell body, often extending for hundreds of micrometers and branching multiple times, giving rise to a complex "dendritic tree". An axon (also called a nerve fiber) is a special cellular extension (process) that arises from the cell body at a site called the axon hillock and travels for a distance, as far as 1 meter in humans or even more in other species. Most neurons receive signals via the dendrites and send out signals down the axon. For an action potential to be sent down the axon, a threshold signal must be received by the dendrites and transmitted to the axon hillock. If the signal is strong enough when it reaches the axon hillock, a single all or nothing action potential will be sent down the axon causing the release of neurotransmitters into the synaptic cleft, as depicted in Figure 4.11.

Numerous axons are often bundled into fascicles that make up the nerves in the peripheral nervous system (like strands of wire make up cables). Bundles of axons in the central nervous system are called tracts. The cell body of a neuron frequently gives rise to multiple dendrites, but never to more than one axon, although the axon may branch hundreds of times before it terminates. At the majority of synapses, signals are sent from the axon of one neuron to a dendrite of another. There are, however, many exceptions to these rules: for example, neurons can lack dendrites, or have no axon, and synapses can connect an axon to another axon or a dendrite to another dendrite.

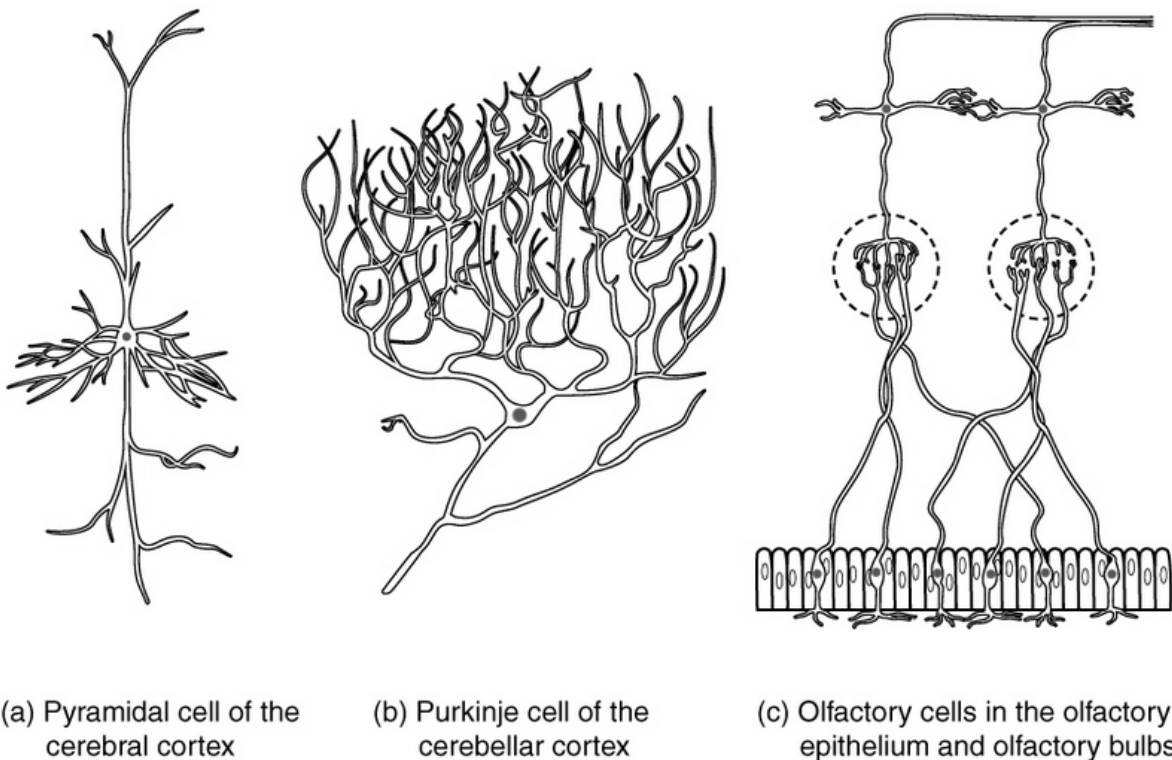

Figure 4.9 Examples of Different Types of Neurons. (a) Pyramidal neurons found in the cerebral cortex is a multipolar cell with a cell body that is shaped somewhat like a pyramid. (b) The Purkinje cell in the cerebellum was named after the scientist that originally described it. (c) Olfactory neurons are named for their function in the sense of smell.

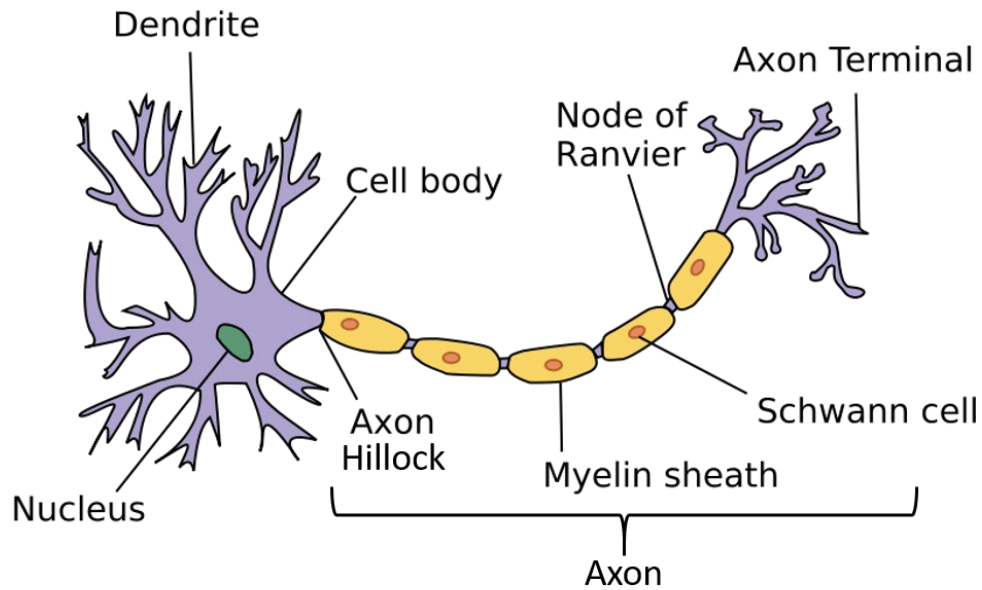

Figure 4.10 Anatomy of a Neuron. Depicted within the diagram is the neuron with the central cell body (soma) and typical dendrite and axon projections. The dendrites of a neuron are typically where outside signals are received and the axon is the used to transmit the chemical signal to downstream target cells in the communication pathway. Figure adapted from [Wikimedia](#)

To become an excitable cell that can transmit an electric signal, neurons generate a negative resting potential within their cells. This is accomplished by sequestering cations and anions in different concentrations either inside the cell (intracellular) or outside the cell (extracellular). This leaves the inside of the neuron with a resting potential of -70 mV. Thus, the cell is said to be polarized or negatively charged. The neuron is able to generate this negative resting potential largely through the use of the Sodium (Na⁺)/Potassium (K⁺) ATPase Protein. This protein is embedded in the plasma membrane of all neurons, where it functions as a pump. **Protein pumps** use energy to physically pump molecules across the plasma membrane against their concentration gradient. The energy being used for this process is Adenosine Triphosphate (ATP). In this case, 3 sodium ions are pumped out of the cell, while 2 potassium ions are pumped inside the cell for each ATP molecule that is broken down into Adenosine Diphosphate (ADP) (Figure 4.12). This creates an electrochemical gradient where a high concentration of sodium ions are outside of the cell and a high concentration of potassium ions are inside the cell. Similarly,

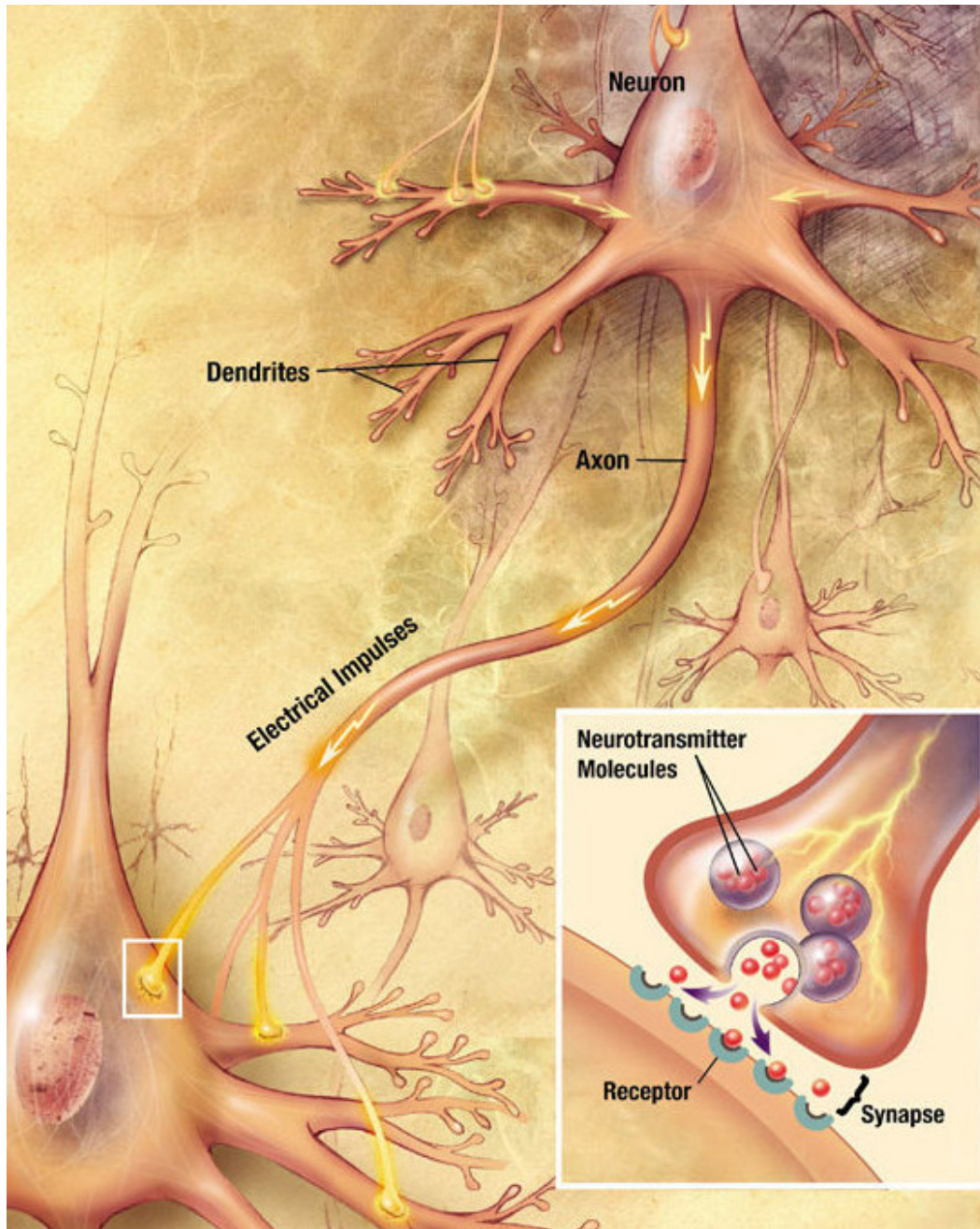

Figure 4.11 Neuronal Signaling. This diagram depicts the cell-cell communication between neurons after the firing of an action potential down the axon of a pre-synaptic neuron. At the axon terminal, secretory vesicles containing neurotransmitters such as serotonin and dopamine, are released into the synaptic cleft where they can interact with receptors on the dendrite or soma of the post-synaptic neuron. Figure provided by [Wikimedia](#).

calcium ions accumulate on the outside of the neuron. The inside of the cell also contains numerous organic anions and phosphate anions causing the large negative resting potential of -70 mV within the cell.

The Na⁺/K⁺ ATPase pump is widely expressed in all neurons and is constantly working to maintain this gradient. In fact, this is one of the major uses of energy within the body consuming almost 20% of the body's total energy each day. The formation of this concentration gradient makes it possible for neurons to send electrical impulses down the cell axon and communicate with downstream target cells. This makes it possible to think, move our muscles, and sense the outside world through touch, sight, hearing and smell.

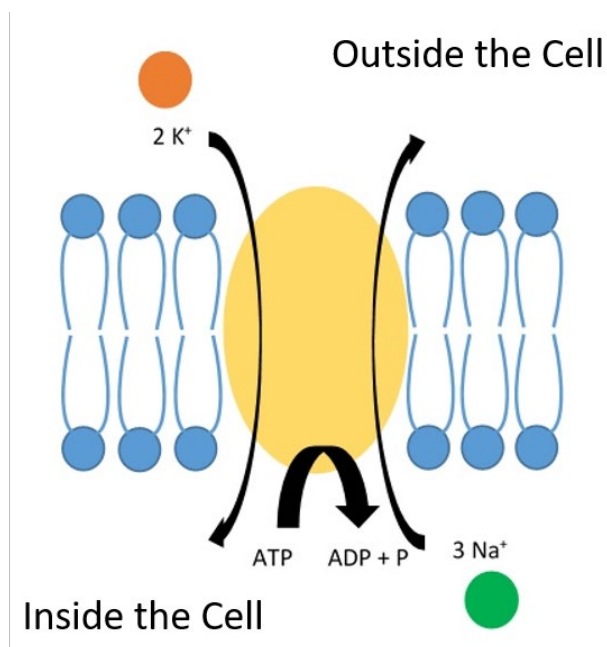

Figure 4.12. The Sodium-Potassium ATPase Pump. The Na⁺/K⁺ ATPase Pump uses the energy of ATP to pump 3 Na⁺ out the cell and 2 K⁺ into the cell. This gradient enables neurons to maintain a resting electrical potential of -70 mV within the cell.

Image from [Wikimedia Commons](https://commons.wikimedia.org/wiki/File:Na_K_Pump.png)

To generate an action potential, a neuron needs a ripple of positive current to flow down the axon. When it reaches the terminal of the axon, this is a signal that neurotransmitters, such as dopamine, serotonin or glutamate should be released into the synaptic cleft (Fig. 4.11) These small chemical messengers are used to communicate with the downstream neuron or muscle cell. Within the neuron, **ion channels** play an important role in generating the action potential. **ion channels** are proteins embedded within the plasma membrane of the neuron that form a pore large enough for specific ions to pass through. **ion channels** do not use energy and can only allow the ions to flow down their

concentration gradient from an area of higher concentration to an area of lower concentration through a process called **facilitated diffusion**.

Two types of ion channels that are important for generating an action potential are **receptor/ligand activated channels** and **voltage-gated channels**. For the receptor/ligand activated channel, a small molecule that is acting as a chemical messenger (also called a **ligand**), binds to the receptor and causes a conformational change that opens the ion channel (Fig. 4.13). Usually these types of receptors are found on the dendrite of the receiving neuron, where they will bind to neurotransmitters. Once bound to a neurotransmitter, the receptor opens a calcium channel, allowing calcium ions to flow quickly into the cell making the local area become less negative inside. When the charge inside the neuron becomes closer to zero (or more neutral), this is called a **depolarization** event.

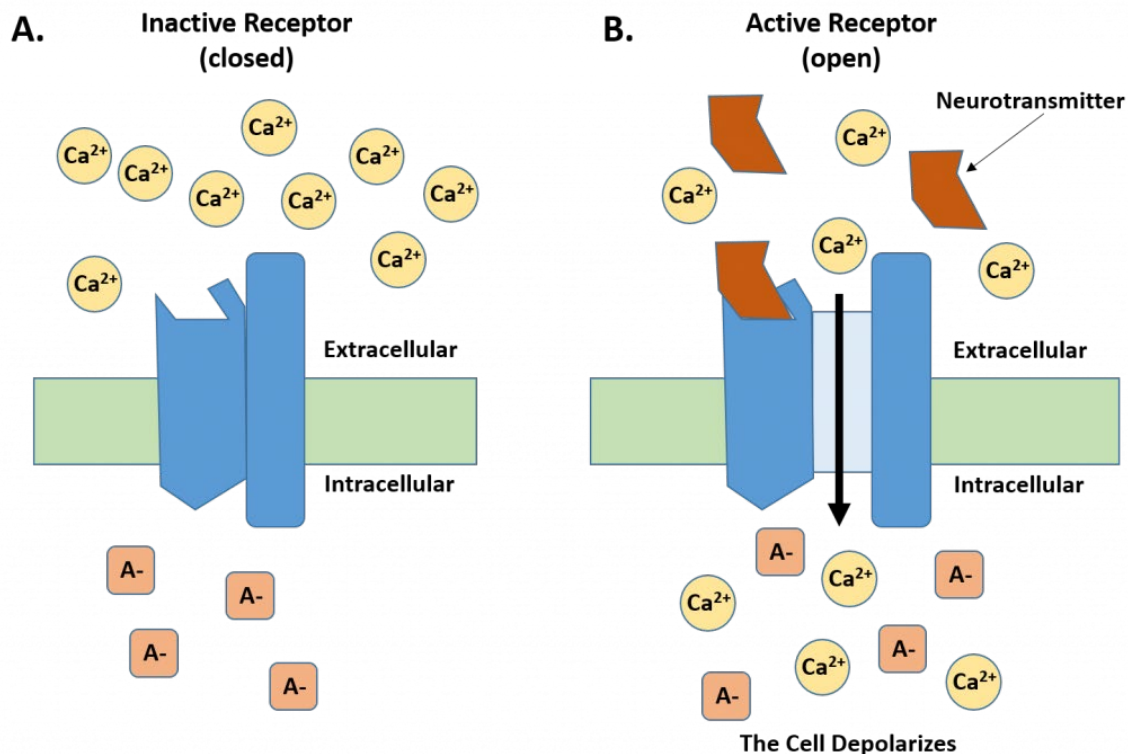

Figure 4.13. Receptor/Ligand Activated Channels. (A) Shows a receptor in the closed conformation during the resting state of the neuron. Note that calcium ions are in high concentration outside of the cell while increased anion concentrations inside the cell create a -70 mV resting state. (B) When neurotransmitters are released from the axon into the synapse, they will bind with the receptor causing a conformational change in the receptor that opens the calcium ion channel. Ca^{2+} flows into the cell down its concentration gradient causing localized depolarization within the cell.

This localized depolarization event, if strong enough, can activate neighboring voltage-gated sodium channels (Fig. 4.14A). These channels are sensitive to the charge state in the neuron and will open when the charge is reduced in the local area. At this time, the voltage-gated sodium channels will undergo a structural change that allows sodium ions to rapidly flow into the cell, down their concentration gradient. This will further cause the neuron to depolarize and cause the opening of other voltage-gated sodium channels that are in close proximity. When the charge state of the neuron surpasses neutral and becomes positive on the inside (approximately +30 mV), the voltage-gated sodium channels undergo another conformational change, closing the channels and stopping the inflow of sodium ions. At this point, the voltage-gated potassium channels are activated allowing potassium ions the flow out of the cell down their concentration gradient (Fig. 4.14B).

The opening of the voltage-gated potassium channels restores the negative resting potential of the neuron. However, the ion gradients are out of balance at this time period with high levels of sodium inside the cell and high levels of potassium outside of the cell. This creates an **absolute refractory period** where the neuron cannot be reactivated. Once the potassium channels have closed and the negative potential of the neuron has been restored, the neuron enters a **relative refractory period** where a new action potential is inhibited but not impossible to elicit. During this time, the Na⁺/K⁺ ATPase pump restores the ion gradient, such that sodium is pumped out of the cell, and potassium is pumped back into the cell. At this point, the neuron is reset and is fully sensitive to receiving another signal. This can be represented graphically in terms of voltage over time, where the action potential depolarization event can be correlated with the opening and closing of the specific ion channels (Fig 4.15) The entire action potential can be accomplished within 4-5 milliseconds (mS).

The refractory period in one location in the neuron, also allows the directional movement of the depolarization event from the dendrites of the neuron and through the cell body. If the signal is strong enough to depolarize the neuron to a state of -55 mV when it reaches the axon hillock, this will generate an action potential that will be sent down the axon of the neuron. This is a committed step by the neuron that will cause the release of neurotransmitters into the synaptic cleft, signaling the activation of the downstream neuron or target cell.

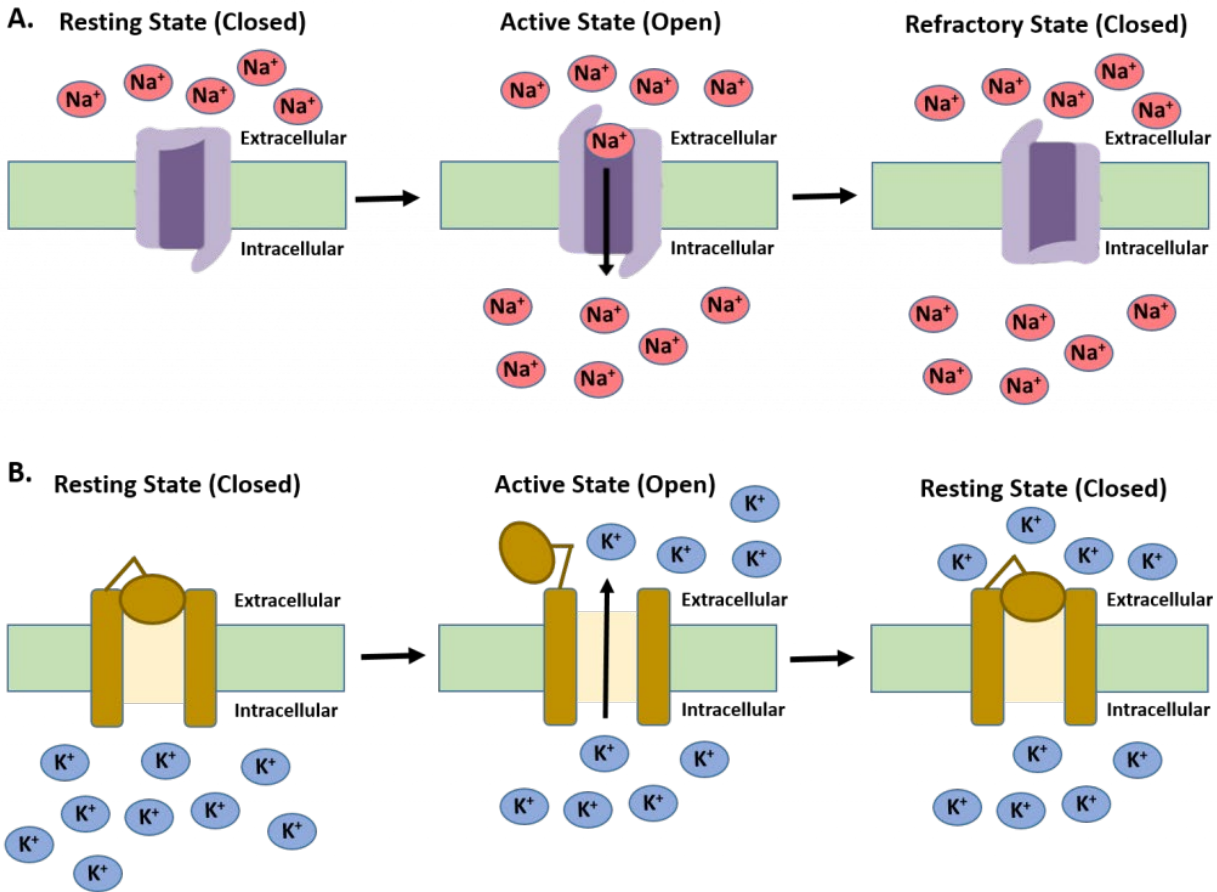

Figure 4.14 Voltage-Gated Ion Channels. (A) The Voltage-Gated Sodium Channels are closed when the neuron is in the resting state. Following neurotransmitter stimulation, the cellular depolarization causes the voltage-gated sodium channels to undergo a conformational change, opening the sodium channel and allowing the influx of Na⁺ into the cell. When the cellular charge becomes positive (approximately +30 mV) the voltage-gated Na⁺ channels close due to an additional conformational change and enters a refractory period where it cannot be reactivated. The lowering of the charge state within the neuron to -70 mV restores the protein conformation to the resting state. (B) The voltage-gated potassium channel is closed during the resting state of the neuron and is not activated until the polarity of the cell shifts to approximately +30 mV. Following activation, potassium ions move out of the cell, down their concentration gradient and restore the resting potential of the neuron to -70 mV.

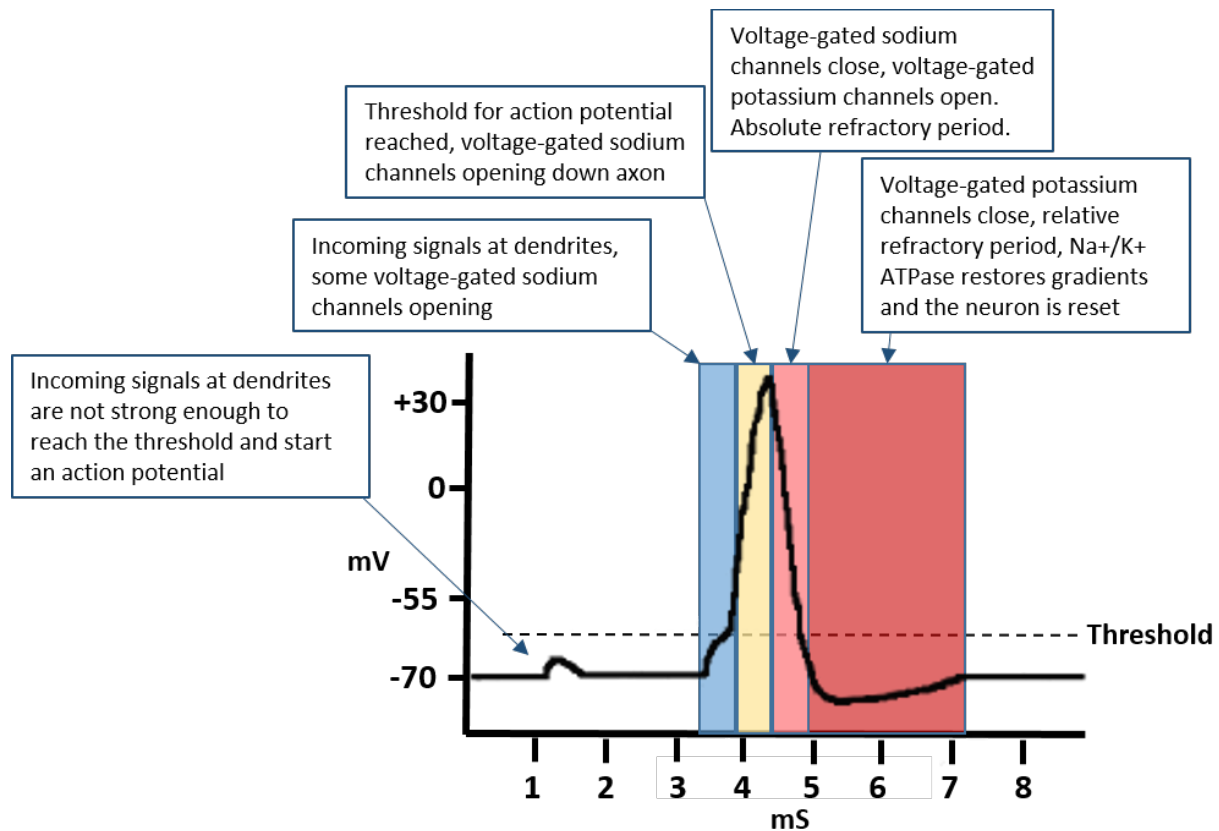

Figure 4.15 Graphic Representation of an Action Potential. The resting state potential of a neuron is -70 mV. An action potential is propagated down an axon when a threshold of -55 mV reaches the axon hillock. This causes the opening of voltage-gated sodium channels along the axon and the release of neurotransmitter from the axon terminal. The voltage-gated sodium channels close and become refractory when the cell potential reaches +30 mV. This also results in the opening of the voltage-gated potassium channels which re-establish the resting state potential of the neuron. The Na⁺/K⁺ ATPase Pump restores the Na⁺ and K⁺ gradients within the neuron during the relative refractory period and enables the neuron to fully reset and fire another action potential.

Note that these are only two examples of how ion channels can be regulated. Some ion channels can also be activated by the physical movement of the cell, such as the hair cells located in the inner ear, or by other chemical changes such as phosphorylation. Some ion channels are leaky and are open all the time, allowing the slow, continual movement of ions across the membrane. This keeps the osmotic pressure under control and doesn't allow it to build up to dangerous levels, similar to having the overflow valve on your bathtub, so that the water doesn't get too high and overflow the bathtub.

Video Tutorial on the Action Potential

Section 4.11: Chapter Summary

If an atom has gained one or more electrons, it is negatively charged and is called an **anion**. If an atom has lost one or more electrons, it is positively charged and is called a **cation**. Metals generally form cations while nonmetals generally form anions. Because opposite charges attract (while like charges repel), these oppositely charged ions attract each other, forming **ionic bonds**. The resulting compounds are called ionic compounds. The simplest ionic compounds are binary ionic compounds or those that only contain two atoms, one acting as the cation, and one acting as the anion.

The tendency of an atom toward a configuration in which it possesses eight valence electrons is referred to as the "**Octet Rule**." The term **isoelectronic** refers to an atom and an ion of a different atom (or two different ions) that have the same electron configuration. Cations lose electrons to become isoelectronic with the noble gas in the previous row (period) on the table. Anions gain electrons to become isoelectronic with the noble gas in the same row as the anion. The periodic table can be used to predict common ion states for the elements

During ionic bond formation, electron dot diagrams can be used to illustrate electron movements. Stable ionic compounds have a balanced charge state such that the charge on the overall molecule is zero. When writing chemical formulas, the cation is always first and the anion is always last. Stable chemical formulas must be written so that the overall compound has a net neutral charge (ie the total positive charge = the total negative charge). Subscripts are used to show how many atoms are present within an ionic formula. Chemical formulas are always reduced to show the lowest number of each cation and anion required for a single compound to form.

Cations are named by using the element name followed by the word 'ion'. Roman numerals are added after the element name if a cation has more than one ionic form. Anions are named by dropping the last part of the element name and replacing it with the suffix '-ide' followed by the word 'ion'. When naming an ionic compound the cation name, including roman numerals when needed, is placed first, followed by the anion name. **Polyatomic ions** are ions that form from multiple atoms that are covalently bonded together. Polyatomic ions behave as a single group when participating in ionic bonding. Naming ionic compounds that contain polyatomic ions is done in exactly the

same way as with other binary ionic compounds. The name of the cation comes first (using roman numerals when necessary) followed by the name of the anion.

Solid ionic compounds typically form a continuous three-dimensional network or lattice, usually in a crystalline structure, rather than individual molecules. Ionic compounds typically have high melting and boiling points, and are hard and brittle. As solids, they are most often electrically insulating, but when melted or dissolved they become highly conductive, because the ions are mobilized. Mobilized ions in solution are called **electrolytes**.

Using the Arrhenius definitions, ionic compounds containing hydrogen ions (H^+) are classified as acids, and those containing hydroxide (OH^-) or oxide (O^{2-}) ions are classified as bases. All other ionic compounds without these ions are known as salts. Naming salts and basic ionic compounds follows standard ionic nomenclature rules. In naming acids from binary compounds, the prefix 'hydro-' is used to represent the cation H^+ , and the suffix '-ic' acid is used to indicate that it is an acidic form. If an acid contains a polyatomic ion, no leading prefix is used to indicate the H^+ cation. This is implied within the name. For polyatomic anions ending with the suffix '-ate', the acid is named as the [anion name] + the '-ic acid' suffix. If a polyatomic anion has the '-ite' ending, the acid name will be written as the [anion name] + the '-ous acid' suffix. The prefixes 'hypo-' and 'per-' are also retained in the acid nomenclature for elements that have many oxyanion states.

Neurons are electrically excitable cells that use ion gradients to generate nerve impulses called **action potentials**. Ion gradients are set up within the neuron through the use of ion pumps such as the Na^+/K^+ ATPase Protein. **Ion pumps** use energy to transport ions across the cell membrane against their concentration gradient. This sets up a resting membrane potential within the neuron of -70 mV and a condition where Na^+ is in high concentration outside of the cell and K^+ is in high concentration inside of the cell. **Ion channel proteins** use **facilitated diffusion** to transport ions across the plasma membrane down their concentration gradient. **Receptor/Ligand ion channels** in the dendrites of the neuron bind with neurotransmitters and cause the depolarization of the localized region. Voltage-gated sodium channels are activated allowing Na^+ to flow into the cell and cause further depolarization. If the cell is depolarized to -55 mV at the axon hillock, and action potential will be generated down the axon and neurotransmitters will be released by the neuron. The resting potential of the neuron is reset by the opening of voltage-gated potassium channels. The Na^+/K^+ ATPase pump is then utilized to reset the ion gradients to prepare the neuron for another signaling event. The whole process takes approximately 4-5 milliseconds. Overall, neural signaling in humans uses approximately 20% of total energy consumption.

Section 4.12: References

1. Ball, D. W.; Hill J. W.; Scott, R. J. The Basics of General, Organic, and Biological Chemistry. Published under Creative Commons by-nc-sa 3.0. Available at: [https://chem.libretexts.org/Textbook_Maps/Introductory_Chemistry_Textbook_Maps/Map%3A_The_Basics_of_GOB_Chemistry_\(Ball_et_al.\)](https://chem.libretexts.org/Textbook_Maps/Introductory_Chemistry_Textbook_Maps/Map%3A_The_Basics_of_GOB_Chemistry_(Ball_et_al.))
2. Poulsen, T. (2010) Introduction to Chemistry. Published under Creative Commons by-nc-sa 3.0. Available at: <http://openedgroup.org/books/Chemistry.pdf>
3. Wikipedia. Mercury (element). Published under Creative Commons by-sa 3.0 Unported License. Available at: [https://en.wikipedia.org/wiki/Mercury_\(element\)](https://en.wikipedia.org/wiki/Mercury_(element))
4. Wikipedia. St. Elmo's fire. Published under Creative Commons by-sa 3.0 Unported License. Available at: https://en.wikipedia.org/wiki/St._Elmo's_fire
5. Bernhoft R. A. Mercury Toxicity and Treatment: A Review of the Literature. **J. Environ. Public Health. 2012, 2012**, 1-10. Available from: <https://www.hindawi.com/journals/jeph/2012/460508/abs/>
6. Wikipedia. Bromoperoxidase. Published under Creative Commons by-sa 3.0 Unported License. Available at: <https://en.wikipedia.org/wiki/Bromoperoxidase>
7. Bewick, S., Parsons, R., Forsythe, T., Robinson, S., and Dupon, J. (2016) Introductory Chemistry (CK-12) **LibreTexts**. [https://chem.libretexts.org/Textbook_Maps/Introductory_Chemistry_Textbook_Maps/Map%3A_Introductory_Chemistry_\(CK-12\)/08%3A_Ionic_and_Metallic_Bonding/8.03%3A_Cation_Formation](https://chem.libretexts.org/Textbook_Maps/Introductory_Chemistry_Textbook_Maps/Map%3A_Introductory_Chemistry_(CK-12)/08%3A_Ionic_and_Metallic_Bonding/8.03%3A_Cation_Formation)
8. General Chemistry/Naming Substances. (2017, March 16). *Wikibooks, The Free Textbook Project*. Retrieved 15:35, April 13, 2017 from https://en.wikibooks.org/w/index.php?title=General_Chemistry/Naming_Substances&oldid=3196789.
9. Mercury(I) chloride. (2017, January 18). In *Wikipedia, The Free Encyclopedia*. Retrieved 18:21, April 14, 2017, from [https://en.wikipedia.org/w/index.php?title=Mercury\(I\)_chloride&oldid=760689931](https://en.wikipedia.org/w/index.php?title=Mercury(I)_chloride&oldid=760689931)
10. Blue mass. (2016, October 2). In *Wikipedia, The Free Encyclopedia*. Retrieved 18:11, April 15, 2017, from https://en.wikipedia.org/w/index.php?title=Blue_mass&oldid=742175689
11. Wikipedia contributors. (2018, December 13). Neuron. In *Wikipedia, The Free Encyclopedia*. Retrieved 22:45, December 13, 2018, from <https://en.wikipedia.org/w/index.php?title=Neuron&oldid=873450803>

12. Openstax. (2016) Chapter 12: The Nervous System and Nervous Tissue. In Rice University's Online Textbook, Anatomy and Physiology. Retrieved Dec 13th, 2018 from: <https://opentextbc.ca/anatomyandphysiology/chapter/12-2-nervous-tissue/>
13. File:Sodium-Potassium Pump.jpg. (2017, January 3). *Wikimedia Commons, the free media repository*. Retrieved 00:26, December 14, 2018 from https://commons.wikimedia.org/w/index.php?title=File:Sodium-Potassium_Pump.jpg&oldid=228564972.
14. Wikipedia contributors. (2018, December 8). Synapse. In *Wikipedia, The Free Encyclopedia*. Retrieved 03:15, December 14, 2018, from <https://en.wikipedia.org/w/index.php?title=Synapse&oldid=872616292>

Chapter 5: Covalent Bonds and Introduction to Organic Molecules

Chemical bonds are generally divided into two fundamentally different types: ionic and covalent. In reality, however, the bonds in most substances are neither purely ionic nor purely covalent, but lie on a spectrum between these extremes. Although purely ionic and purely covalent bonds represent extreme cases that are seldom encountered in any but very simple substances, a brief discussion of these two extremes helps explain why substances with different kinds of chemical bonds have very different properties. Ionic compounds consist of positively and negatively charged ions held together by strong electrostatic forces, whereas covalent compounds generally consist of molecules, which are groups of atoms in which one or more pairs of electrons are shared between bonded atoms. In a covalent bond, atoms are held together by the electrostatic attraction between the positively charged nuclei of the bonded atoms and the negatively charged electrons they share. This chapter will focus on the properties of covalent compounds.

Section 5.1: Introduction to Covalent Molecules and Compounds

Just as an atom is the simplest unit that has the fundamental chemical properties of an element, a molecule is the simplest unit that has the fundamental chemical properties of a covalent compound. Thus, the term molecular compound is used to describe elements that are covalently bonded and to distinguish the compounds from ionic compounds. Some pure elements exist as covalent molecules. Hydrogen, nitrogen, oxygen, and the halogens occur naturally as the diatomic (“two atoms”) molecules H_2 , N_2 , O_2 , F_2 , Cl_2 , Br_2 , and I_2 (part (a) in Figure 4.1). Similarly, a few pure elements exist as polyatomic (“many atoms”) molecules, such as elemental phosphorus and sulfur, which occur as P_4 and S_8 (part (b) in Figure 5.1).

Each covalent compound is represented by a molecular formula, which gives the atomic symbol for each component element, in a prescribed order, accompanied by a subscript indicating the number of atoms of that element in the molecule. The subscript is written only if the number of atoms is greater than 1. For example, water, with two hydrogen atoms and one oxygen atom per molecule, is written as H_2O . Similarly, carbon dioxide,

which contains one carbon atom and two oxygen atoms in each molecule, is written as CO_2 .

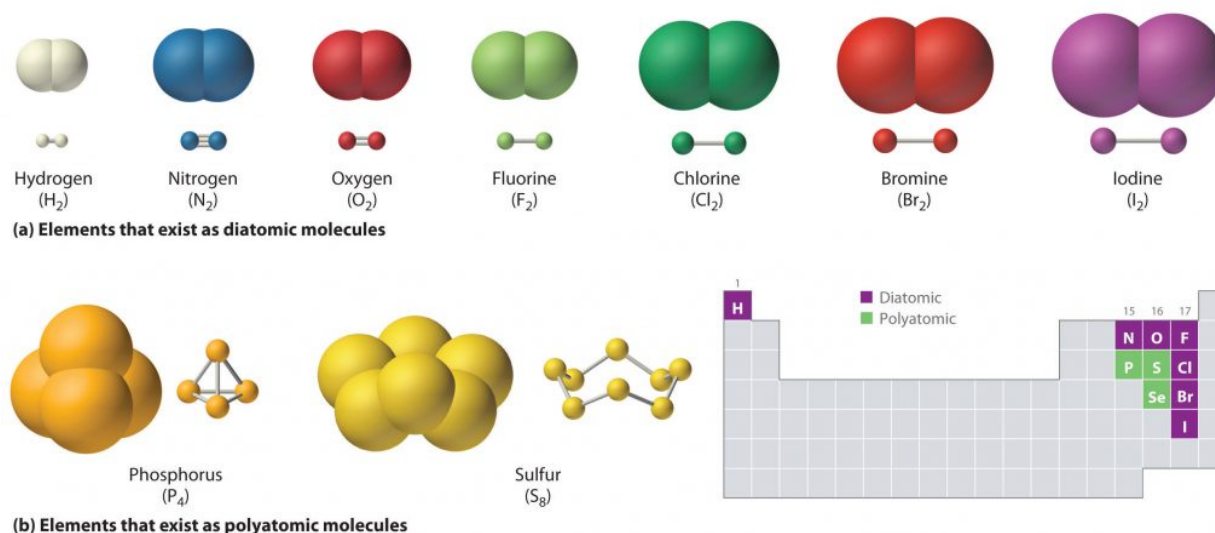

Figure 5.1 Elements That Exist as Covalent Molecules. (a) Several elements naturally exist as diatomic molecules, in which two atoms (E) are joined by one or more covalent bonds to form a molecule with the general formula E_2 . (b) A few elements naturally exist as polyatomic molecules, which contain more than two atoms. For example, phosphorus exists as P_4 tetrahedra—regular polyhedra with four triangular sides—with a phosphorus atom at each vertex. Elemental sulfur consists of a puckered ring of eight sulfur atoms connected by single bonds. Selenium is not shown due to the complexity of its structure.

Note that hydrogen, which is placed with the alkali metals on the periodic table, most often forms covalent bonds with other atoms. This is because hydrogen is an exception to the octet rule and only needs one additional electron to fill its valence electron rule

Covalent compounds that contain carbon and hydrogen are called **organic compounds**. The convention for representing the formulas of organic compounds is to write carbon first, followed by hydrogen and then any other elements in alphabetical order (e.g., CH_4O is methyl alcohol, a fuel). Compounds that consist primarily of elements other than carbon and hydrogen are called inorganic compounds; they include both covalent and ionic compounds. The convention for writing inorganic compounds, involves listing the

component elements beginning with the one farthest to the left in the periodic table, as in SO_2 or SF_6 . Those in the same group are listed beginning with the lower element and working up, as in ClF . By convention, however, when an inorganic compound contains both hydrogen and an element from groups 13–15, hydrogen is usually listed last in the formula. Examples are ammonia (NH_3) and silane (SiH_4). Compounds such as water, whose compositions were established long before this convention was adopted, are always written with hydrogen first: Water is always written as H_2O , not OH_2 . Typically this distinguishes when hydrogen is participating in a covalent bond rather than an ionic interaction, as seen in many of the inorganic acids, such as hydrochloric acid (HCl) and sulfuric acid (H_2SO_4), as described in chapter 4.

How to Recognize Covalent Bonds

In Chapter 4, we saw that ionic compounds are composed predominantly of a metal + a nonmetal. Covalent molecules, on the other hand, are typically composed of two nonmetals or a nonmetal and a metalloid. This is an initial screening method that you can use to categorize compounds into the ionic or the covalent category.

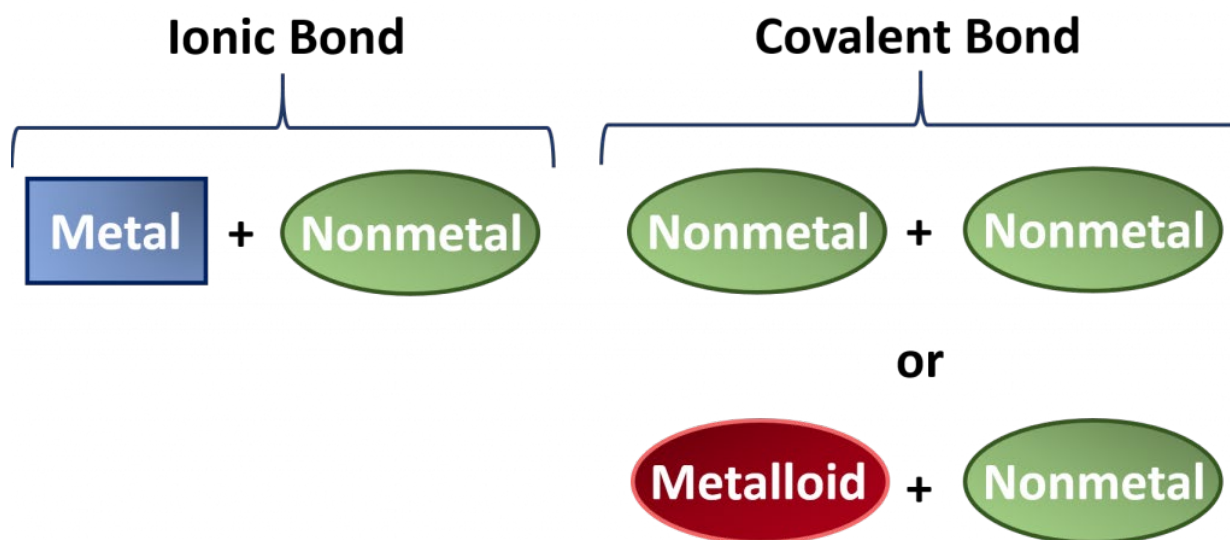

Figure 5.2 Recognizing Ionic vs Covalent Compounds. Typically compounds that are formed from a combination of a metal with a nonmetal have more ionic bond character whereas compounds formed from two nonmetals or a metalloid and a nonmetal show more covalent character. Although compounds usually lie on a spectrum somewhere between fully ionic and fully covalent character, for naming purposes, this guideline works well.

Section 5.2: Electron Sharing

Predicting the Correct Number of Bonds

Recall that the octet rule helped us determine that carbon has four electrons in its valence shell and would thus, need to create four covalent bonds to reach an octet. Similarly, nitrogen and phosphorus each make three bonds, oxygen and sulfur each make two, and the halogens only make one bond. Hydrogen is an exception to the octet rule as it is the smallest element and its valence shell is filled with two electrons. Thus, hydrogen can only form one bond with another atom. Sulfur and phosphorus can also have bonding patterns that are exceptions to the octet rule. They both can have expanded orbital bonding with phosphorus also routinely forming five covalent bonds, and sulfur being capable of forming either four or six covalent bonds. Table 5.1 provides a graphic representation of these patterns. When you are drawing organic molecules, it is important to pay attention to the bonding rules so that all atoms reach their preferred bonding states.

Single Covalent Bonds Between the Same Atoms

Chapter 4 described how electrons can be transferred from one atom to another so that both atoms have an energy-stable outer electron shell following the **octet rule**. However, there is another way an atom can achieve a full valence shell: atoms can share electrons to reach the octet state (or the duet state in the case of hydrogen).

This concept can be illustrated by using two hydrogen atoms, each of which has a single electron in its valence shell. (For small atoms such as hydrogen atoms, the valence shell will be the first shell, which holds only two electrons.) We can represent the two individual hydrogen atoms as follows:

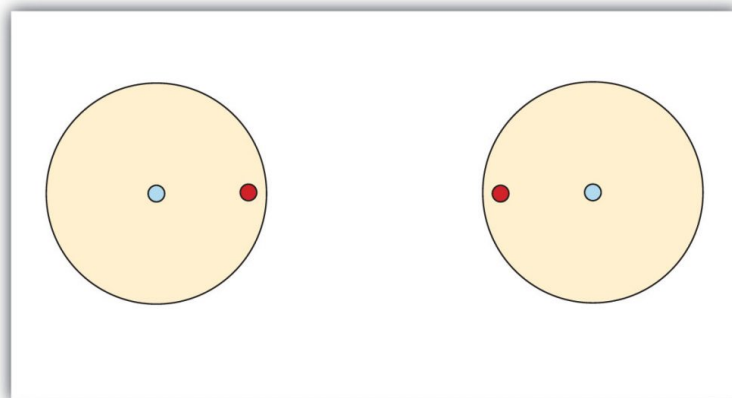
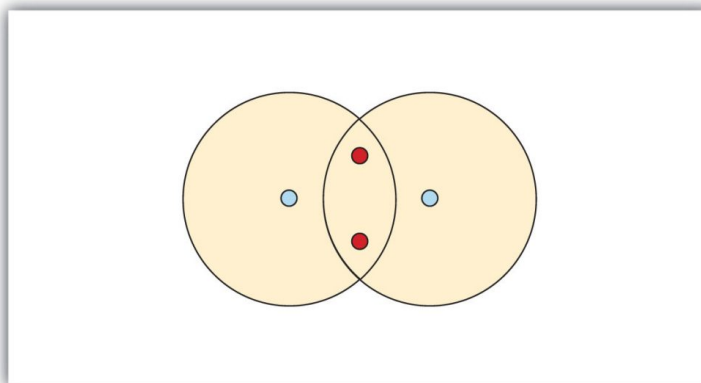

Table 5.1: Covalent Bonding Patterns of Atoms Commonly Atoms

Electron Pairs	Carbon	Hydrogen	Oxygen	Nitrogen	Phosphorus	Sulfur
Normal Octet Bonding						
Expanded Bonding						
Expanded Bonding						
Bonded Pairs	Four	One	Two	Three	Three, Five	Two, Four, Six
Lone pairs	None	None	Two	One	One, None	Two, None, None

*Note: Hydrogen doesn't really follow the octet rule as its valence shell is full with 2 e⁻

In this situation above, neither hydrogen can reach the preferred duet state. In contrast, when two hydrogen atoms get close enough together to share their electrons, they can be represented as follows:



By sharing their valence electrons, both hydrogen atoms now have two electrons in their respective valence shells. Because each valence shell is now filled, this arrangement is more stable than when the two atoms are separate. In this configuration, each hydrogen has an electron configuration equivalent to that of the noble gas, helium. The sharing of electrons between atoms is called a covalent bond, and the two electrons that join atoms in a covalent bond are called a bonding pair of electrons. A discrete group of atoms connected by covalent bonds is called a molecule—the smallest part of a compound that retains the chemical identity of that compound. For example, one molecule of water would contain two hydrogen atoms and one oxygen atom (H₂O).

Chemists frequently use **Lewis electron dot diagrams** to represent covalent bonding in molecular substances. For example, the Lewis diagrams of two separate hydrogen atoms are as follows:



The Lewis diagram of two hydrogen atoms sharing electrons looks like this:



This depiction of molecules is simplified further by using a dash to represent a covalent bond. The hydrogen molecule is then represented as follows:



Remember that the dash, also referred to as a single bond, represents a pair of bonding electrons.

The bond in a hydrogen molecule, measured as the distance between the two nuclei, is about 7.4×10^{-11} m, or 74 picometers (pm; $1 \text{ pm} = 1 \times 10^{-12}$ m). This particular bond length represents a balance between several forces: (1) the attractions between oppositely charged electrons and nuclei, (2) the repulsion between two negatively charged electrons, and (3) the repulsion between two positively charged nuclei. If the nuclei were closer together, they would repel each other more strongly; if the nuclei were farther apart, there would be less attraction between the positive and negative particles.

Fluorine is another element whose atoms bond together in pairs to form diatomic (two-atom) molecules. Two separate fluorine atoms have the following electron dot diagrams:



Each fluorine atom contributes one valence electron, making a single bond and giving each atom a complete valence shell, which fulfills the octet rule:



The circles show that each fluorine atom has eight electrons around it. As with hydrogen, we can represent the fluorine molecule with a dash in place of the bonding electrons:



Each fluorine atom has six electrons, or three pairs of electrons, that are not participating in the covalent bond. Rather than being shared, they are considered to belong to a single atom. These are called nonbonding pairs (or lone pairs) of electrons.

Single Covalent Bonds Between Different Atoms

Now that we have looked at electron sharing between atoms of the same element, let us look at covalent bond formation between atoms of different elements. Consider a molecule composed of one hydrogen atom and one fluorine atom:



Each atom needs one additional electron to complete its valence shell. By each contributing one electron, they make the following molecule:

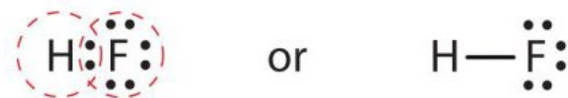

In this molecule, the hydrogen atom does not have nonbonding electrons, while the fluorine atom has six nonbonding electrons (three lone electron pairs). The circles show how the valence electron shells are filled for both atoms (recall that hydrogen is filled with two electrons).

Larger molecules are constructed in a similar fashion, with some atoms participating in more than one covalent bond. For example, water, with two hydrogen atoms and one oxygen atom, and methane (CH_4), with one carbon atom and four hydrogen atoms, can be represented as follows:

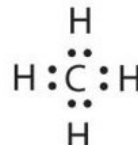
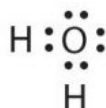

Atoms typically form a characteristic number of covalent bonds in compounds. Figure 5.3 shows valence electron configurations of each element family (or column).

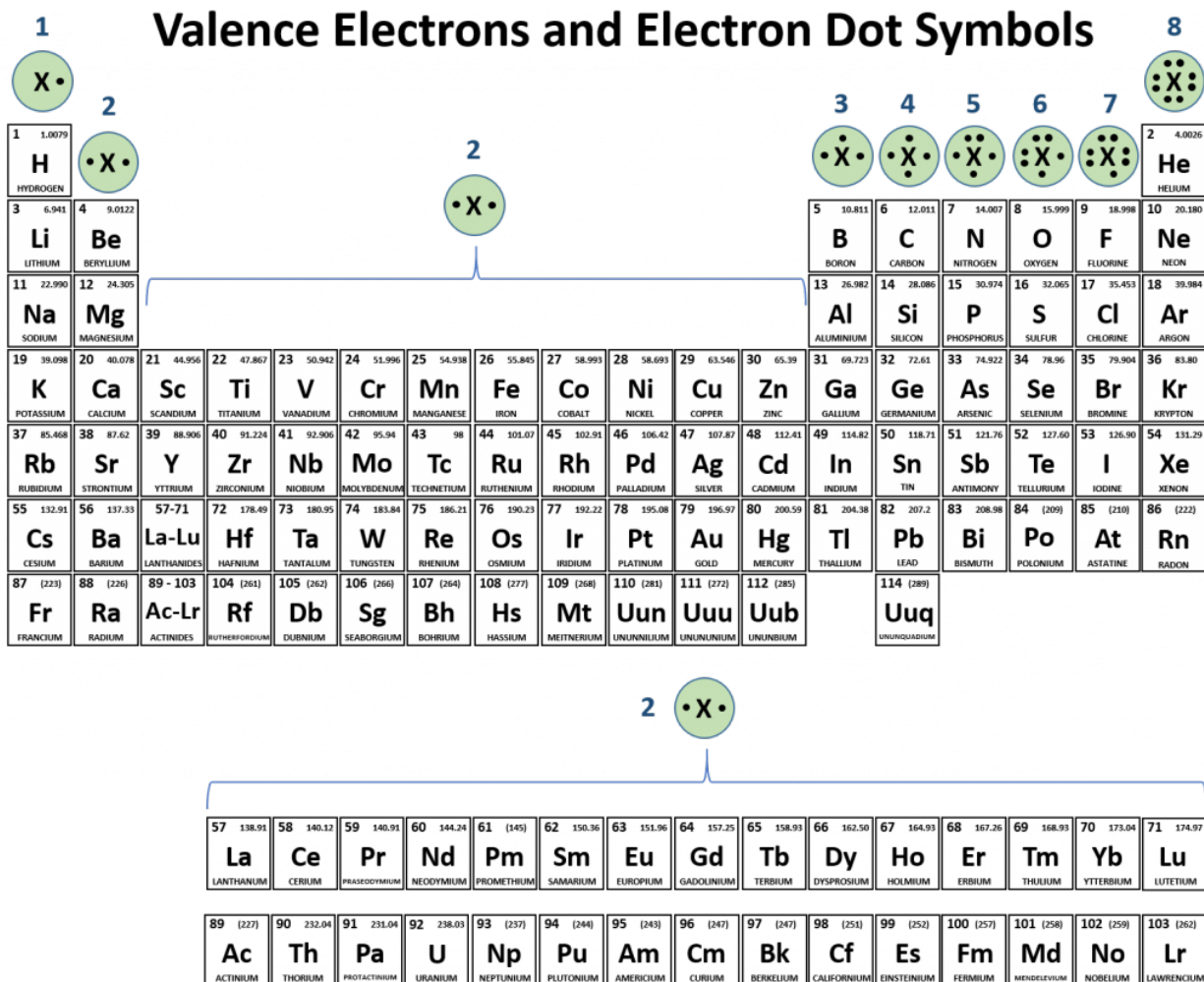

Fig 5.3 Periodic Table with Lewis Structures. Each family shows a representative Lewis structure for that group of elements. For the nonmetals (Families 4A, 5A, 6A, and 7A) they can accept a complementary number of shared bonds to reach the octet state. Family 4A can share 4 covalent bonds ($4 + 4 = 8$), whereas Families 5A, 6A, and 7A can share 3, 2, and 1 covalent bond(s), respectively, to achieve the octet state. Exceptions to the octet rule do exist. For example, hydrogen can be considered to be in Group 1 or Group 7A because it has properties similar to both groups. Hydrogen can participate in either ionic or covalent bonding. When participating in covalent bonding, hydrogen only needs two electrons to have a full valence shell. As it has one electron to start with, it can only make one covalent bond. Similarly, boron has 3 electrons in its outer shell. This nonmetal typically forms 3 covalent bonds, having a maximum of 6 electrons in its outer shell. Thus, boron can never reach the octet state. Other atoms can have expanded orbitals and accept additional covalent bonds. Two of these that are important for living systems are sulfur and phosphorus. By the octet rule, sulfur can make 2 covalent bonds and phosphorus 3

covalent bonds. Sulfur can also have expanded orbitals to accept 4 or 6 covalent bonds, and phosphorus can expand to 5 covalent bonds.

Concept Review:

1. Draw the Lewis diagram for each compound.
 - A. a molecule composed of two chlorine atoms
 - B. a molecule composed of a hydrogen atom and a bromine atom

Answers:

Solution

Chlorine has the same valence shell electron configuration as fluorine, so the Lewis diagram for a molecule composed of two chlorine atoms is similar to the one for fluorine:



Bromine has the same valence shell electron configuration as fluorine, so the Lewis diagram for a molecule composed of a hydrogen atom and a bromine atom is similar to that for hydrogen and fluorine:



Test Yourself:

1. Draw the Lewis diagram for each compound.
 - A. a molecule composed of one chlorine atom and one fluorine atom
 - B. a molecule composed of one hydrogen atom and one iodine atom

Multiple Covalent Bonds

In many molecules, the octet rule would not be satisfied if each pair of bonded atoms shares only two electrons. Consider carbon dioxide (CO_2). If each oxygen atom shares one electron with the carbon atom, we get the following:

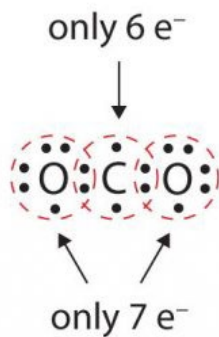

This does not give either the carbon or oxygen atoms a complete octet; The carbon atom only has six electrons in its valence shell and each oxygen atom only has seven electrons in its valence shell. Thus, none of the atoms can reach the octet state in the current configuration. As written, this would be an unstable molecular conformation.

Sometimes more than one pair of electrons must be shared between two atoms for both atoms to have an octet. In carbon dioxide, a second electron from each oxygen atom is also shared with the central carbon atom, and the carbon atom shares one more electron with each oxygen atom:

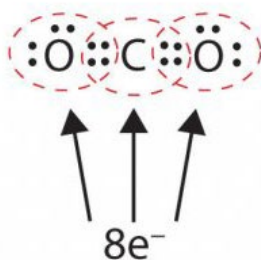

In this arrangement, the carbon atom shares four electrons (two pairs) with the oxygen atom on the left and four electrons with the oxygen atom on the right. There are now eight electrons around each atom. Two pairs of electrons shared between two atoms make a double bond between the atoms, which is represented by a double dash:

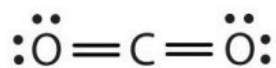

Some molecules contain triple bonds, covalent bonds in which three pairs of electrons are shared by two atoms. A simple compound that has a triple bond is acetylene (C_2H_2), whose Lewis diagram is as follows:



Concept Review:

1. Draw the Lewis diagram for each molecule.

- A. N_2
- B. CH_2O (The carbon atom is the central atom.)

Answers:

Solution

A. The bond between the two nitrogen atoms is a triple bond. The Lewis diagram for N_2 is as follows:



B. In CH_2O , the central atom is surrounded by two different types of atoms. The Lewis diagram that fills each atom's valence electron shell is as follows:

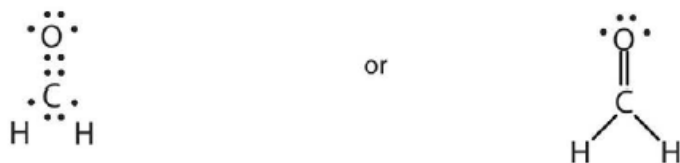

Test Yourself:

Draw the Lewis diagram for each molecule.

- A. O_2
- B. C_2H_4

Coordinate Covalent Bonds

A coordinate bond (also called a dative covalent bond) is a covalent bond (a shared pair of electrons) in which **both** electrons come from the same atom. A covalent bond is formed by two atoms sharing a pair of electrons. The atoms are held together because the electron pair is attracted by both of the nuclei. In the formation of a simple or ordinary covalent bond, each atom supplies one electron to the bond - but that does not have to be the case. In the case of a coordinate covalent bond, one atom supplies both of the electrons and the other atom does not supply any of the electrons. The following reaction between ammonia and hydrochloric acid demonstrates the formation of a coordinate covalent bond between ammonia and a hydrogen ion (proton).

The reaction between ammonia and hydrochloric acid

If these colorless gases are allowed to mix, a thick white smoke of solid ammonium chloride is formed.

[video width="480" height="360" mp4="http://www.wou.edu/chemistry/files/2017/04/Gas-Phase-Acid-Base-Reaction-Between-Ammonia-and-Hydrochloric-Acid.mp4"][/video]

Video provided by [North Carolina School of Science and Mathematics](#)

The overall reaction is



Ammonium ions, NH_4^+ , are formed by the transfer of a hydrogen ion (a proton) from the hydrochloric acid molecule to the lone pair of electrons on the ammonia molecule. To visualize this reaction, we can use electron dot configurations to observe the electron movement during the reaction. First recall the valence electron states for all of the atoms involved in the reaction:

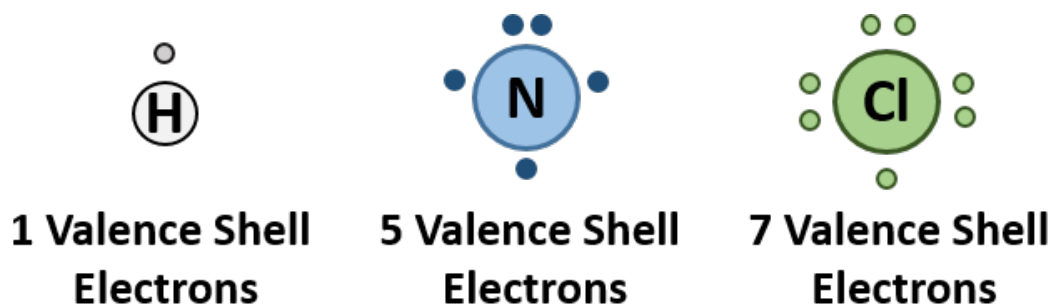

On the left side of the equation (to the left of the arrow) are the reactants of the reaction (ammonia and hydrochloric acid). On the right side of the reaction (to the right of the arrow) is the product of the reaction, the ionic compound - ammonium chloride. The diagram below shows the electron and proton movement during the reaction.

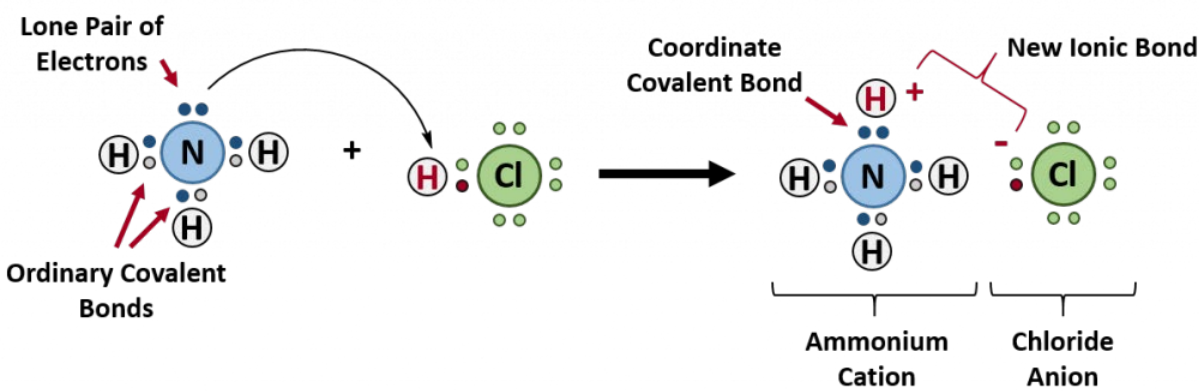

Figure 5.4 Formation of Ammonium Chloride. When the ammonium ion, NH_4^+ , is formed, the fourth hydrogen (shown in red) is attached by a coordinate covalent bond, because only the hydrogen's nucleus is transferred from the chlorine to the nitrogen. The hydrogen's electron is left behind on the chlorine to form a negative chloride ion. Once the ammonium ion has been formed it is impossible to tell any difference between the coordinate covalent and the ordinary covalent bonds, all of the hydrogens are equivalent in the molecule and the extra positive charge is distributed throughout the molecule. Although the electrons are shown differently in the diagram, there is no difference between them in reality. In simple diagrams, a coordinate bond is shown by a curved arrow. The arrow points from the atom donating the lone pair to the atom accepting it.

Section 5.3: Electronegativity and Bond Polarity

Although we defined covalent bonding as electron sharing, the electrons in a covalent bond are not always shared equally by the two bonded atoms. Unless the bond connects two atoms of the same element, there will always be one atom that attracts the electrons in the bond more strongly than the other atom does, as shown in Figure 5.5. When such an imbalance occurs, there is a resulting buildup of some negative charge (called a partial negative charge and designated δ^-) on one side of the bond and some positive charge (designated δ^+) on the other side of the bond. A covalent bond that has an unequal sharing of electrons, as in part (b) of Figure 5.5, is called a **polar covalent bond**. A covalent

bond that has an equal sharing of electrons (part (a) of Figure 5.5) is called a nonpolar covalent bond.

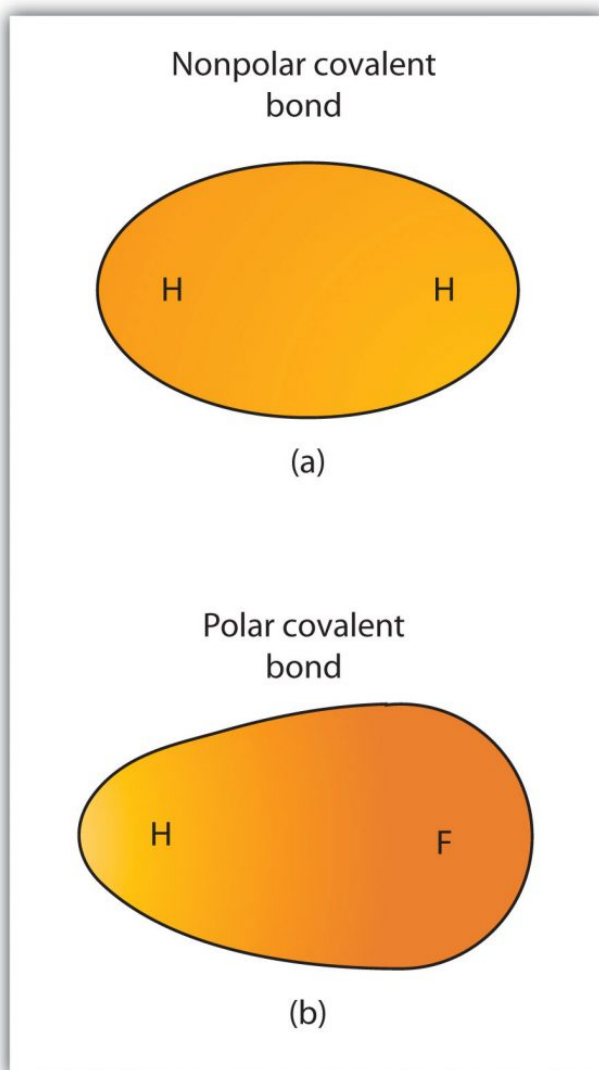

Figure 5.5 Polar versus Nonpolar Covalent Bonds. (a) The electrons in the covalent bond are equally shared by both hydrogen atoms. This is a nonpolar covalent bond. (b) The fluorine atom attracts the electrons in the bond more than the hydrogen atom does, leading to an imbalance in the electron distribution. This is a polar covalent bond.

Any covalent bond between atoms of different elements is a polar bond, but the degree of polarity varies widely. Some bonds between different elements are only minimally polar, while others are strongly polar. Ionic bonds can be considered the ultimate in polarity, with electrons being transferred completely rather than shared. To judge the

relative polarity of a covalent bond, chemists use **electronegativity**, which is a relative measure of how strongly an atom attracts electrons when it forms a covalent bond.

There are various numerical scales for rating electronegativity. Figure 5.6 shows one of the most popular—**the Pauling scale**. The polarity of a covalent bond can be judged by determining the difference in the electronegativities between the two atoms making the bond. The greater the difference in electronegativities, the greater the imbalance of electron sharing in the bond.

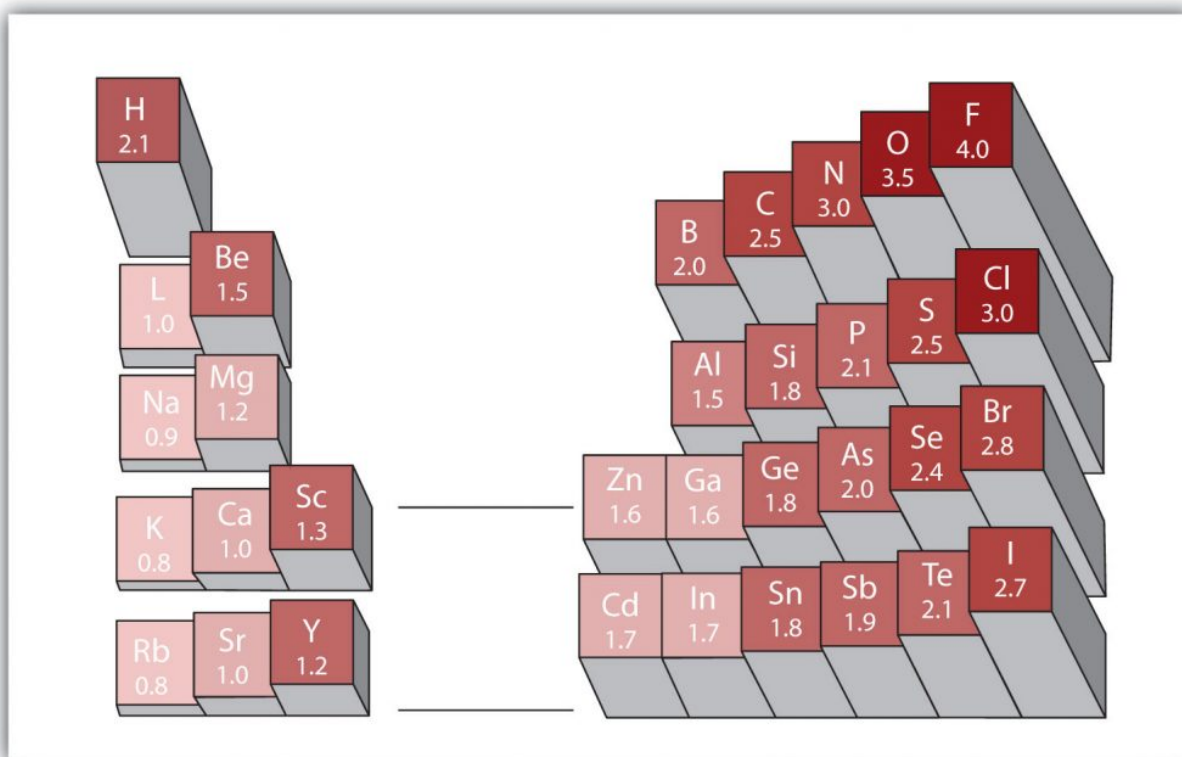

Figure 5.6 Electronegativities of Various Elements. The Pauling Scale for electronegativities has the value for fluorine atoms set at 4.0, the highest value.

Although there are no hard and fast rules, the general rule is that a difference in electronegativity less than 0.4 indicates the bond is nonpolar; when the difference is greater than 0.4, the bond is considered polar. When the difference in electronegativities is large enough (generally greater than about 1.8), the resulting compound is considered ionic rather than covalent. An electronegativity difference of zero, of course, indicates a nonpolar covalent bond. Examples of electronegativity difference are shown in Figure 5.7.

Linus Pauling – A Closer Look

Arguably the most influential chemist of the 20th century, Linus Pauling (1901–94) is the only person to have won two individual (that is, unshared) Nobel Prizes. In the 1930s, Pauling used new mathematical theories to enunciate some fundamental principles of the chemical bond. His 1939 book *The Nature of the Chemical Bond* is one of the most significant books ever published in chemistry.

By 1935, Pauling's interest turned to biological molecules, and he was awarded the 1954 Nobel Prize in Chemistry for his work on protein structure. (He was very close to discovering the double helix structure of DNA when James Watson and James Crick announced their own discovery of its structure in 1953.) He was later awarded the 1962 Nobel Peace Prize for his efforts to ban the testing of nuclear weapons.

In his later years, Pauling became convinced that large doses of vitamin C would prevent disease, including the common cold. Most clinical research failed to show a connection, but Pauling continued to take large doses daily. He died in 1994, having spent a lifetime establishing a scientific legacy that few will ever equal.

Linus Pauling was one of the most influential chemists of the 20th century.

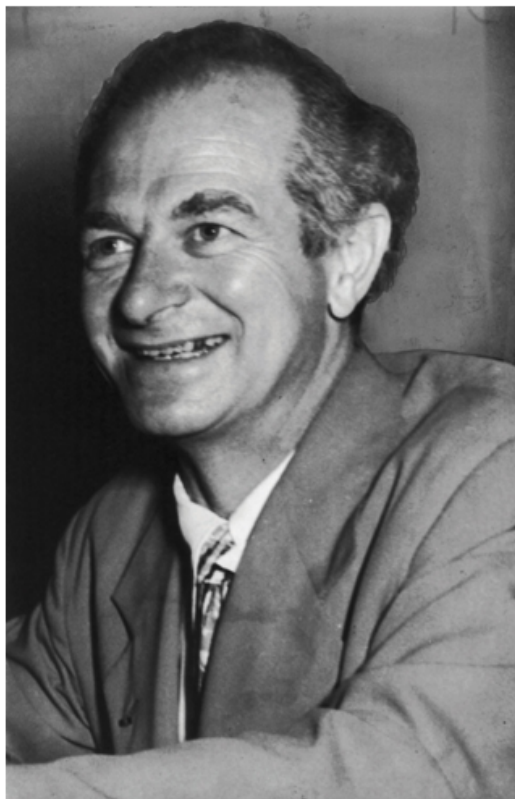

Electronegativity Difference

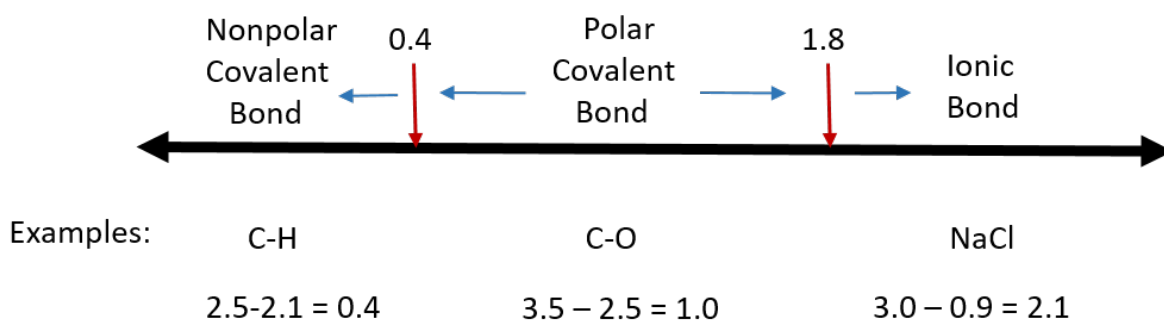
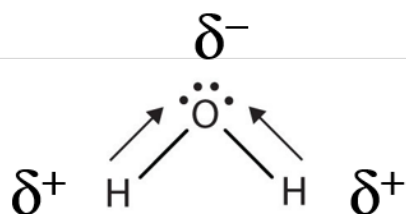

Figure 5.7 Electronegativity Difference Diagram. The diagram above is a guide for discerning what type of bond forms between two different atoms. By taking the difference between the electronegativity values for each of the atoms involved in the bond, the bond type and polarity can be predicted. Note that full ionic character is rarely reached, however when metals and nonmetals form bonds, they are named using the rules for ionic bonding.

When a molecule's bonds are polar, the molecule as a whole can display an uneven distribution of charge, depending on how the individual bonds are oriented. For example, the orientation of the two O–H bonds in a water molecule (Figure 5.8) is bent: one end of the molecule has a partial positive charge, and the other end has a partial negative charge. In short, the molecule itself is polar. The polarity of water has an enormous impact on its physical and chemical properties. (For example, the boiling point of water [100°C] is high for such a small molecule and is due to the fact that polar molecules attract each other strongly.) In contrast, while the two C=O bonds in carbon dioxide are polar, they lie directly opposite each other in the molecule and so cancel each other's effects. Thus, carbon dioxide molecules are nonpolar overall. This lack of polarity influences some of carbon dioxide's properties. (For example, carbon dioxide becomes a gas at –77°C, almost 200° lower than the temperature at which water boils.)



Polar molecule? yes

(a)

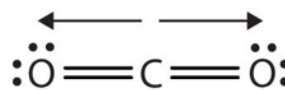

Polar molecule? no

(b)

Figure 5.8 Physical Properties and Polarity. The physical properties of water (a) and carbon dioxide (b) are affected by their molecular polarities. Note that the arrows in the diagram always point in the direction where the electrons are more strongly attracted. In this diagram, the delta symbol (δ) is used with a (+) or (-) symbol to represent partial positive and partial negative charge distribution in polar covalent bonds. Note that the electrons shared in polar covalent bonds will be attracted to and spend more time around the atom with the higher electronegativity value. When the polarity is equal and directly opposing, as in the case of carbon dioxide (b), the overall molecule will have no overall charge.

Tutorial on Electronegativity and Bond Polarity By [Professor Dave Explains](#)

Concept Review:

1. Describe the electronegativity difference between each pair of atoms and the resulting polarity (or bond type).

- A. C and N
- B. H and H
- C. Na and F
- D. O and H

Answers:

Solution

- A. Carbon has an electronegativity of 2.5, while the value for nitrogen is 3.0. The difference is 0.5, which is just slightly polar.
- B. Both hydrogen atoms have the same electronegativity value—2.1. The difference is zero, so the bond is nonpolar.
- C. Sodium's electronegativity is 0.9, while fluorine's is 4.0. The difference is 3.1, which is very high, and so sodium and fluorine form an ionic compound.
- D. With 2.1 for hydrogen and 3.5 for oxygen, the electronegativity difference is 1.4. We would expect a very polar bond, but not so polar that the O–H bond is considered ionic.

Test Yourself:

Describe the electronegativity difference between each pair of atoms and the resulting polarity (or bond type).

C and P

K and Br

N and N

Cs and F

Section 5.4: Properties of Molecular Compounds

Molecular compounds have many properties that differ from ionic compounds. Some of the generalizations for this group include much lower melting and boiling points when compared with their ionic counterparts. For example, water (H₂O) has a melting point of 4°C and a boiling point of 100°C compared with NaCl that has a melting point of 801°C and a boiling point of 1,413°C. This is because the full charges created in ionic bonds have much stronger attractive force than the comparatively weak partial charges created in covalent molecules. Thus, ionic compounds tend to form very strong crystalline lattice structures due to the repeating charges of the cation and anion components. Covalent compounds, on the otherhand, do not typically have such well-structured 3-dimensional shapes. Thus they tend to be more brittle and break more easily when in solid form, and many are found in liquid and gas phases. In addition, due to their lack of charges, they tend to be poor electrical and thermal conductors. Many are also insoluble in water due to their nonpolar nature (ie oil and water don't mix). Table 5.2 shows common differences between covalent and ionic compounds.

Table 5.2 Comparison of Ionic and Covalent Compounds

	Covalent Bonds	Ionic Bonds
State at room temperature:	gases, liquids or low-melting solids	Crystalline solids
Polarity:	Low	High
Solubility	Few are soluble in water; Many are soluble in organic liquids	Many are water soluble; Not soluble in organic liquids
Formation:	A covalent bond is formed between two non-metals that have similar electronegativities. Neither atom is "strong" enough to attract electrons from the other. For stabilization, they share their electrons from outer molecular orbit with others	An ionic bond is formed between a metal and a non-metal. Non-metals(-ve ion) are "stronger" than the metal(+ve ion) and can get electrons very easily from the metal. These two opposite ions attract each other and form the ionic bond.
Conductivity:	Do not conduct electricity	Conduct electricity when molten or dissolved in water
Melting point:	Low	High
What is it?:	Covalent bonding is a form of chemical bonding between two non metallic atoms which is characterized by the sharing of pairs of electrons between atoms and other covalent bonds.	Ionic bond, also known as electrovalent bond, is a type of bond formed from the electrostatic attraction between oppositely charged ions in a chemical compound. These kinds of bonds occur mainly between a metallic and a non metallic atom.
Boiling point:	Low	High
Examples:	Methane (CH ₄), Hydrochloric acid (HCl)	Sodium chloride (NaCl), Sulfuric Acid (H ₂ SO ₄)
Occurs between:	Two non-metals or a non-metal and a metalloid	One metal and one non-metal

Section 5.5: Naming Binary Molecular Compounds

Recall that a molecular formula shows the number of atoms of each element that a molecule contains. A molecule of water contains two hydrogen atoms and one oxygen atom, so its formula is H_2O . A molecule of octane, which is a component of gasoline, contains 8 atoms of carbon and 18 atoms of hydrogen. The molecular formula of octane is C_8H_{18} . When writing the chemical formula the element that is the least electronegative (the element that is farther left or further down within the same family group) is written first while the more electronegative element is written second. You will be required to know how to name simple binary covalent compounds (compounds composed of two different elements)

The elements that combine to form binary molecular compounds are both nonmetal atoms or they are a combination of a nonmetal and a metalloid. This contrasts with ionic compounds, which were formed from a metal ion and a nonmetal ion. Therefore, binary molecular compounds are different because ionic charges cannot be used to name them or to write their formulas. Another difference is that two nonmetal atoms will frequently combine with one another in a variety of ratios. Consider the elements nitrogen and oxygen. They combine to make several compounds including:

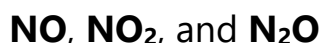

They all can't be called nitrogen oxide. How would someone know which one you were talking about? Each of the three compounds has very different properties and reactivity. A system to distinguish between compounds such as these is necessary.

Prefixes are used in the names of binary molecular compounds to identify the number of atoms of each element. The table below shows the prefixes up to ten.



Figure 5.9 Nitrogen dioxide (NO₂) is a reddish-brown toxic gas that is a prominent air pollutant produced by internal combustion engines.

Table 5.3 Prefixes used for Nomenclature of Binary Covalent Molecules

Number of Atoms	Prefix
1	mono-
2	di-
3	tri-
4	tetra-
5	penta-
6	hexa-
7	hepta-
8	octa-
9	nona-
10	deca-

The rules for using the prefix system of nomenclature of binary compounds can be summarized as follows.

1. Generally, the less-electronegative element is written first in the formula, though there are a few exceptions. **Exception 1:** Carbon is always first in a formula. **Exception 2:** When hydrogen is participating in a covalent bond, it is typically written in the second position (For example: hydrogen is after nitrogen in a formula such as NH_3) Overall, the order of common nonmetals in binary molecular compounds is C, P, N, H, S, I, Br, Cl, O.
2. When naming the first element, use the full name of the element and the appropriate prefix if there are more than one atom of that element in the formula. If there is only one atom for the first element, the term mono- is NOT used, but is implied. For example, CO is carbon monoxide, not monocarbon monoxide.
3. For the second element the ending of the element's name is typically changed to '-ide' and the appropriate prefix is always used for the second element.
4. Note: the **a** or **o** at the end of a prefix is usually dropped from the name when the name of the element begins with a vowel. As an example, four oxygen atoms, is tetroxide instead of tetraoxide. Some examples of molecular compounds are listed in Table 5.4.

Table 5.4 Examples of Naming Covalent Molecules

Formula	Name
NO	nitrogen monoxide
N_2O	dinitrogen monoxide
S_2Cl_2	disulfur dichloride
Cl_2O_7	dichlorine heptoxide

Notice that the **mono-** prefix is not used with the nitrogen in the first compound, but is used with the oxygen in both of the first two examples. The S_2Cl_2 emphasizes that the formulas for molecular compounds are not reduced to their lowest ratios. The **o** of the **mono-** and the **a** of **hepta-** are dropped from the name when paired with oxide. For example:

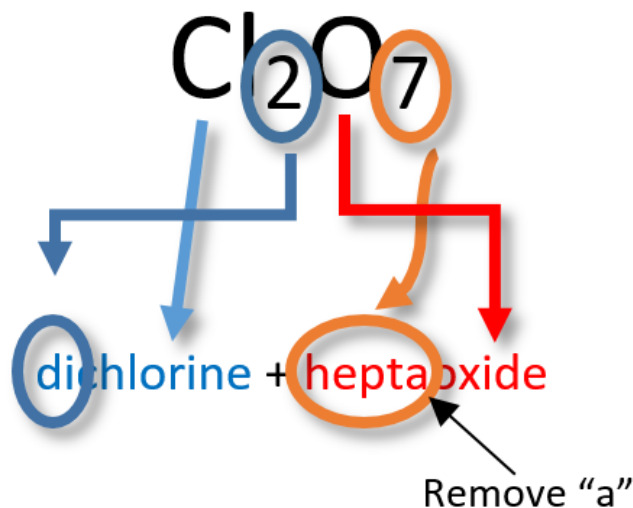

dichlorine heptoxide

Section 5.6: Intermolecular Forces

In addition to learning about how elements join together to form bonds, it is also very important to learn about how molecules interact with other molecules around them. This type of interaction, known as an intermolecular interaction, is important for determining broader characteristics of the molecule including reactivity and function.

Intermolecular interactions between molecules are dependent on the phase that the molecule exists. A phase is a certain form of matter that includes a specific set of physical properties. That is, the atoms, the molecules, or the ions that make up the phase do so in a consistent manner throughout the phase. As mentioned in Chapter 2, science recognizes three stable phases: the solid phase, in which individual particles can be thought of as in contact and held in place (defined volume and shape); the liquid phase, in which individual particles are in contact but moving with respect to each other (defined volume but, shape of the container); and the gas phase (no defined shape or volume), in which individual

particles are separated from each other by relatively large distances. Not all substances will readily exhibit all phases on the Earth. For example, carbon dioxide does not exhibit a liquid or solid phase on Earth unless the pressure is greater than about six times normal atmospheric pressure. Other substances, especially complex organic molecules, may decompose or breakdown at higher temperatures, rather than becoming a liquid or a gas. For example, think about roasting a marshmallow. If it gets too close to the flames it will become charred and blackened, breaking down the sugar molecules inside. The sugar is not converted into the liquid or gaseous phase. Thus, water is very unique in its ability to exist on the Earth in all three phase states (solid ice - liquid water - water vapor).

Which phase a substance adopts depends on the pressure and the temperature it experiences. Of these two conditions, temperature variations are more obviously related to the phase of a substance. When it is very cold, H₂O exists in the solid form as ice. When it is warmer, the liquid phase of H₂O is present. At even higher temperatures, H₂O boils and becomes steam (gaseous phase).

Pressure changes can also affect the presence of a particular phase (as we indicated for carbon dioxide), but its effects are less obvious most of the time. We will mostly focus on the temperature effects on phases, mentioning pressure effects only when they are important. Most chemical substances follow the same pattern of phases when going from a low temperature to a high temperature: the solid phase, then the liquid phase, and then the gas phase. However, the temperatures at which these phases are present differ for all substances and can be rather extreme. Table 5.5 shows the temperature ranges for solid, liquid, and gas phases for three substances. As you can see, there is extreme variability in the temperature ranges. Recall that the melting point of a substance is the temperature that separates a solid and a liquid. The boiling point of a substance is the temperature that separates a liquid and a gas.

Table 5.5 Each Substance has a Characteristic Melting Point and Boiling Point

	Melting Point		Boiling Point
	Solid Below	Liquid Above	Gas Above
Hydrogen (H ₂)	-259°C	-259°C	-253°C
Water (H ₂ O)	0°C	0°C	100°C
Sodium Chloride (NaCl)	801°C	801°C	1413°C

What accounts for this variability? Why do some substances become liquids at very low temperatures, while others require very high temperatures before they become liquids? It all depends on the strength of the intermolecular interactions between the particles of substances. (Although ionic compounds are not composed of discrete molecules, we will still use the term intermolecular to include interactions between the ions in such compounds.) Substances that experience strong intermolecular interactions require higher temperatures to become liquids and, finally, gases. Substances that experience weak intermolecular interactions do not need much energy (as measured by temperature) to become liquids and gases and will exhibit these phases at lower temperatures.

Intermolecular forces determine bulk properties such as the melting points of solids and the boiling points of liquids. Liquids boil when the molecules have enough thermal energy to overcome the intermolecular attractive forces that hold them together, thereby forming bubbles of vapor within the liquid. Similarly, solids melt when the molecules acquire enough thermal energy to overcome the intermolecular forces that lock them into place in the solid.

Intermolecular forces are electrostatic in nature; that is, they arise from the interaction between positively and negatively charged species. Like covalent and ionic bonds, intermolecular interactions are the sum of both attractive and repulsive components. Because electrostatic interactions fall off rapidly with increasing distance between molecules, intermolecular interactions are most important for solids and liquids, where the molecules are close together. These interactions become important for gases only at very high pressures, where they are responsible for the observed deviations from the ideal gas law at high pressures.

Substances with the highest melting and boiling points have **covalent network bonding**. This type of interaction is actually a covalent bond. In these substances, all the atoms in a sample are covalently bonded to the other atoms; in effect, the entire sample is essentially one large molecule. Many of these substances are solid over a large temperature range because it takes a lot of energy to disrupt all the covalent bonds at once. One example of a substance that shows covalent network bonding is diamond (Figure 5.10), which is a form of pure carbon. At temperatures over 3,500°C, diamond finally vaporizes into gas-phase atoms.

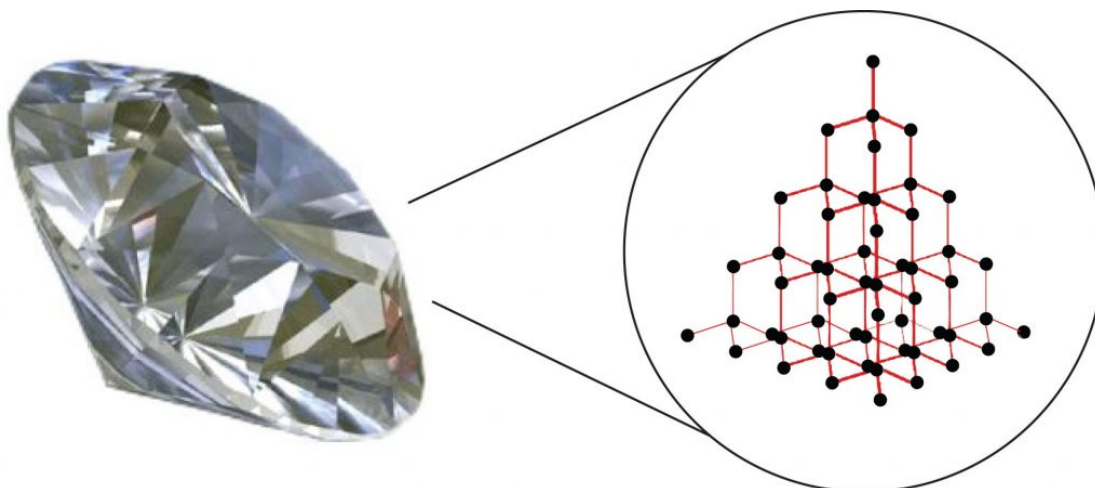

Figure 5.10. Diamond. Diamond, a form of pure carbon, has covalent network bonding. It takes a very high temperature—over 3,500°C—for diamond to leave the solid state. Source: Photo © Thinkstock

For interactions between different molecules, the strongest force between any two particles is the **ionic bond**, in which two ions of opposing charge are attracted to each other. Thus, ionic interactions between particles are an intermolecular interaction. Substances that contain ionic interactions are strongly held together, so these substances typically have high melting and boiling points. Sodium chloride (Figure 5.11) is an example of a substance whose particles experience ionic interactions.

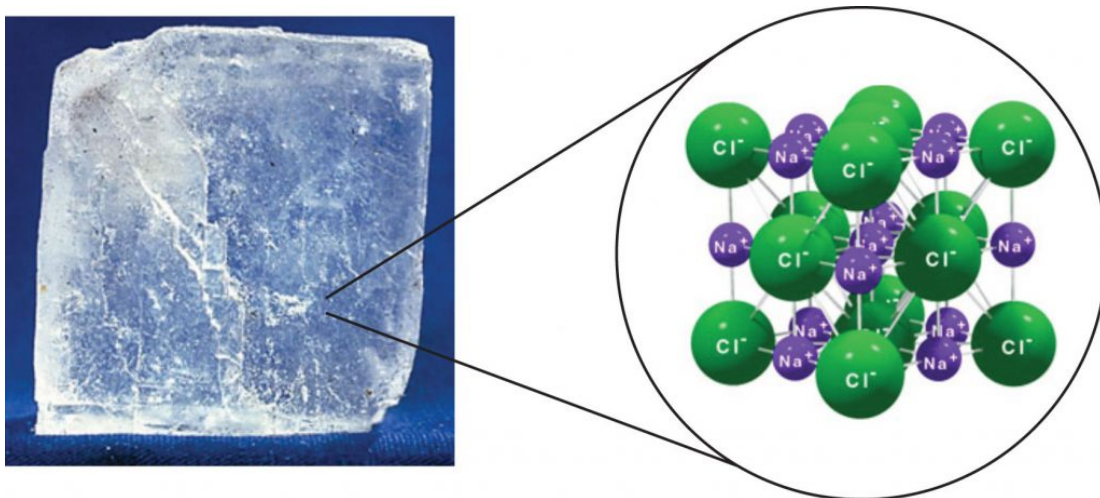

Figure 5.11 Sodium Chloride. Solid NaCl is held together by ionic intermolecular forces. Source: Photo © Thinkstock

Many substances that experience covalent bonding exist as discrete molecules and do not engage in covalent network bonding. Thus, most covalently bonded molecules will also experience intermolecular forces. These intermolecular forces are weaker than those found in ionic interactions and depend on the polarity of the covalent bond. Recall that in polar covalent bonds, the electrons that are shared in a covalent bond are not shared equally between the two atoms in the bond. Typically, the atom displaying higher electronegativity attracts the electrons more strongly than the other, leading to the unequal sharing of electrons in the bond. This sets up a permanent dipole within the molecule, where one end of the molecule has a partial negative charge (δ^-) and one end has a partial positive charge (δ^+). This idea is illustrated in Figure 5.12, which shows a diagram of the covalent bond in hydrogen fluoride (HF).

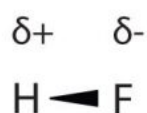

Figure 5.12 Polar Covalent Bonds. The electrons in the HF molecule are not equally shared by the two atoms in the bond. Because the fluorine atom has nine protons in its nucleus, it attracts the negatively charged electrons in the bond more than the hydrogen atom does with its one proton in its nucleus. Thus, electrons are more strongly attracted to the fluorine atom, leading to an imbalance in the electron distribution between the atoms. The fluorine side of the bond picks up a partial overall negative charge (represented by the δ^- in the diagram), while the hydrogen side of the bond has an overall partial positive charge (represented by the δ^+ in the diagram). Such a bond is called a polar covalent bond.

The fluorine atom attracts the electrons in the bond more than the hydrogen atom does. The result is an unequal distribution of electrons in the bond, favoring the fluorine side of the covalent bond. Because of this unequal distribution, the fluorine side of the covalent bond actually takes on a partial negative charge (indicated by the δ^- in Figure 5.12), while the hydrogen side of the bond, being electron deficient, takes on a partial positive charge (indicated by the δ^+ in Figure 5.12). A covalent bond that has an unequal sharing of electrons is called a polar covalent bond. (A covalent bond that has an equal sharing of electrons, as in a covalent bond with the same atom on each side, is called a nonpolar covalent bond.) A molecule with a net unequal distribution of electrons in its covalent bonds is a polar molecule. HF is an example of a polar molecule.

The charge separation in a polar covalent bond is not as extreme as is found in ionic compounds, but there is a related result: oppositely charged ends of different molecules will attract each other. This type of intermolecular interaction is called a **dipole-dipole** interaction. If the structure of a molecule is polar, then the molecule has a net dipole moment. Molecules with net dipole moments tend to align themselves so that the positive end of one dipole is near the negative end of another and vice versa, as shown in part (a) in Figure 5.13. These arrangements are more stable than arrangements in which two positive or two negative ends are adjacent (Figure 5.13, part c). Hence dipole-dipole interactions, such as those in part (b) in Figure 5.13, are attractive intermolecular interactions, whereas those in part (d) in Figure 5.13 are repulsive intermolecular interactions. Because molecules in a liquid move freely and continuously, molecules always experience both attractive and repulsive dipole-dipole interactions simultaneously, as shown in Figure 5.14. On average, however, the attractive interactions dominate.

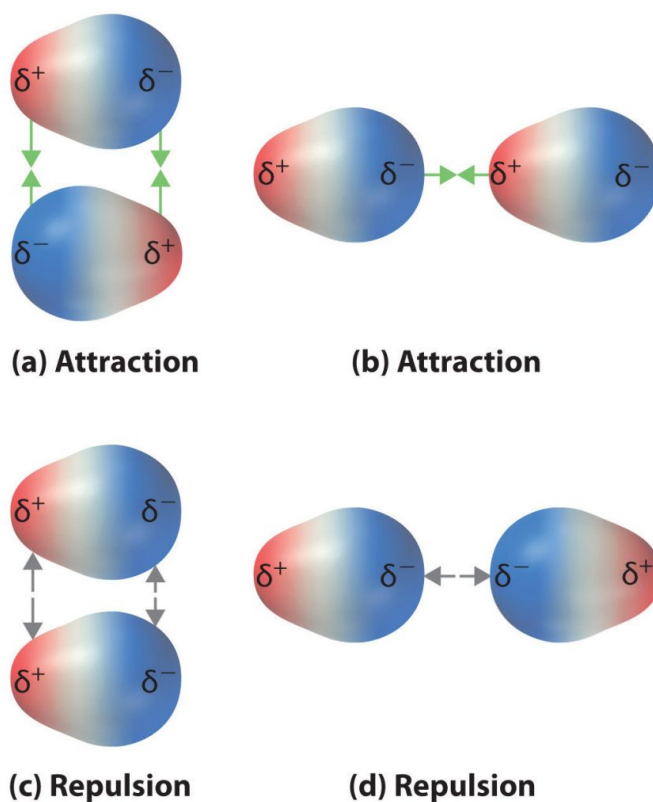

Figure 5.13 Attractive and Repulsive Dipole-Dipole Interactions. (a and b) Molecular orientations in which the positive end of one dipole (δ^+) is near the negative end of another (δ^-) (and vice versa) produce attractive interactions. (c and d) Molecular orientations that juxtapose the positive or negative ends of the dipoles on adjacent molecules produce repulsive interactions.

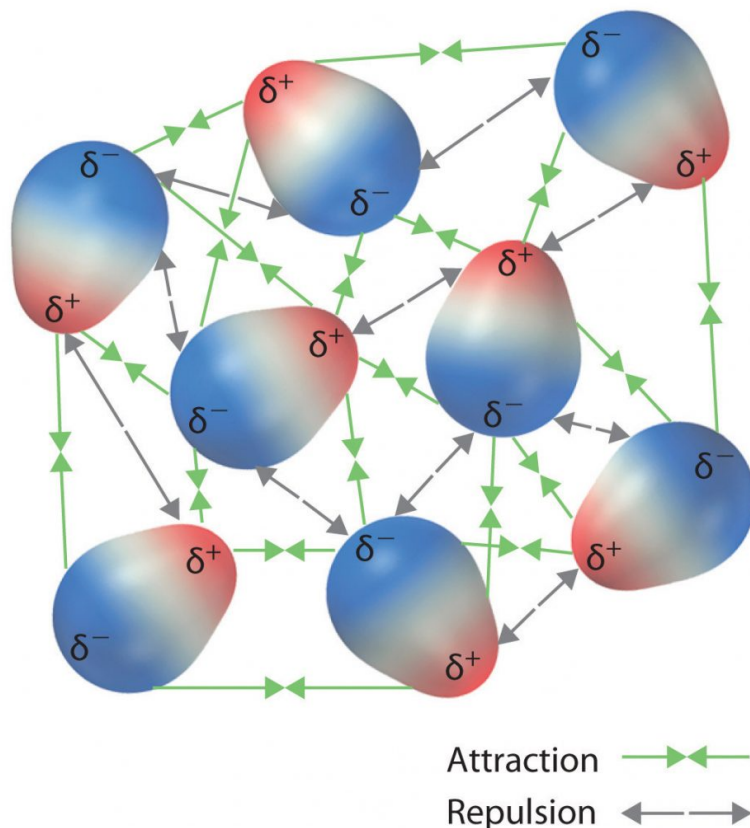

Figure 5.14 Both Attractive and Repulsive Dipole-Dipole Interactions Occur in a Liquid Sample with Many Molecules.

The H–F, O–H, and N–H bonds are strongly polar; In molecules that have these bonds, particularly strong dipole-dipole interactions (as strong as 10% of a true covalent bond) can occur. Because of this strong interaction, **hydrogen bonding** is used to describe this dipole-dipole interaction. The physical properties of water, which has two O–H bonds, are strongly affected by the presence of hydrogen bonding between water molecules. Figure 5.15 shows how molecules experiencing hydrogen bonding can interact in water.

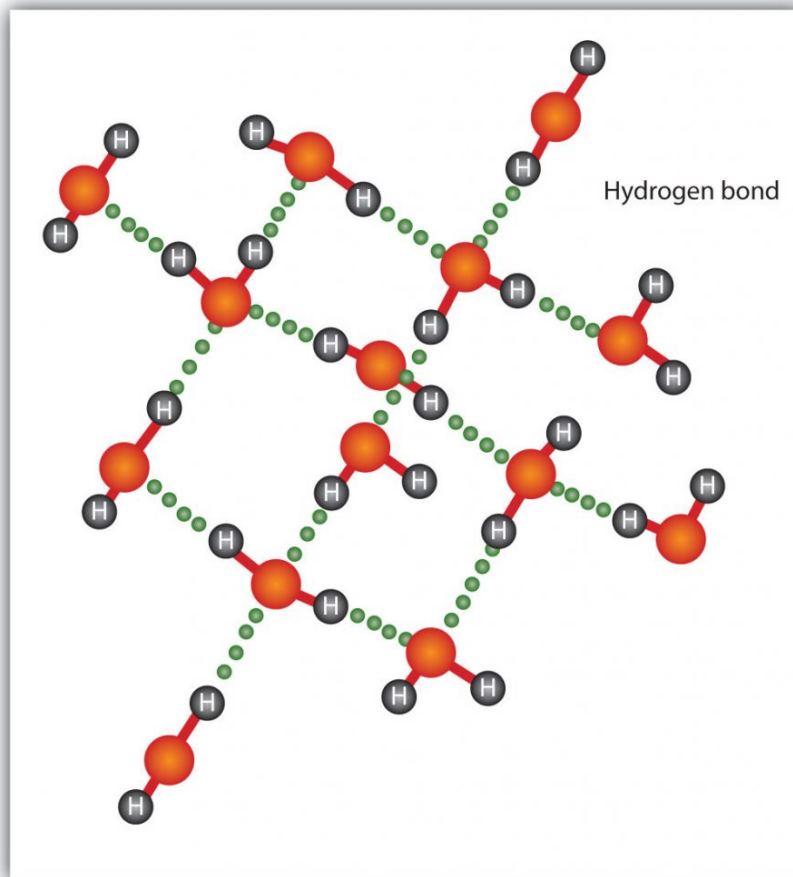

Figure 5.15 Hydrogen Bonding between Water Molecules. The presence of hydrogen bonding in molecules like water can have a large impact on the physical properties of a substance.

Finally, there are forces between all molecules that are caused by electrons being in different places in a molecule at any one time, which sets up a temporary separation of charge that disappears almost as soon as it appears and sets up a momentary 'induced dipole'. These are very weak intermolecular interactions and are called **London dispersion forces**. Since electrons naturally orbit the nucleus of the atom, there are momentary dipoles that are present in the atom as the electrons are shifting from one side to the other. If other atoms are in close proximity, the electrons of the other atoms will orbit in concert with the neighboring atom, i.e. the electrons of one atom are repulsive to the electrons of the neighboring atoms, such that when they are close to the neighboring atom, the neighboring electrons will shift away to the other side of the atom. Thus, the electron movements between atoms of different molecules will synchronize and orbit in a

pattern that maximizes the distance between electrons of a neighboring atom. Note that all substances experience London dispersion forces. However, these are the only intermolecular forces that nonpolar covalent compounds experience. Nonpolar covalent molecules tend to be soft in the solid phase and have relatively low melting points. Butter fat would be a good example of a nonpolar covalent compound.

Because London dispersion forces are caused by the instantaneous distribution of electrons in a molecule, larger molecules with a large number of electrons can experience higher levels of London dispersion forces. Examples include waxes, which are long hydrocarbon chains that are solids at room temperature because the molecules have so many electrons. The resulting dispersion forces between these molecules make them assume the solid phase at normal temperatures.

[Video Tutorial on London Dispersion Forces By Bozeman Science.](#)

The phase that a substance adopts depends on the type and magnitude of the intermolecular interactions the particles of a substance experience. If the intermolecular interactions are relatively strong, then a large amount of energy—in terms of temperature—is necessary for a substance to change phases. If the intermolecular interactions are weak, a low temperature is all that is necessary to move a substance out of the solid phase. Overall, ionic interactions are the strongest intermolecular forces followed by hydrogen bonding, other dipole-dipole interactions, and lastly, induced dipoles (London dispersion forces). Intermolecular force strength is indicated in Table 5.6.

Table 5.6 Strength of Intermolecular Forces

Bond Type	Dissociation Energy (kcal/mol)
Ionic Bond Lattice	250-4000 kcal/mol
Hydrogen Bond	1-12 (water H-bonds are ~5)
Other Dipole-Dipole Interactions	0.5-2
London Dispersion Forces	< 1.0

Source: https://en.wikipedia.org/wiki/Intermolecular_force

Example 1: Intermolecular Forces

Question: What intermolecular forces besides London dispersion forces, if any, exist in each substance listed below? Do you think any of these substances solids at room temperature?

1. potassium chloride (KCl)
2. ethanol (C₂H₅OH)
3. bromine (Br₂)

Solution:

Potassium chloride is composed of ions, so the intermolecular interaction in potassium chloride is ionic forces. Because ionic interactions are strong, it might be expected that potassium chloride is a solid at room temperature.

Ethanol has a hydrogen atom attached to an oxygen atom, so it would experience hydrogen bonding. If the hydrogen bonding is strong enough, ethanol might be a solid at room temperature, but it is difficult to know for certain. (Ethanol is actually a liquid at room temperature.)

Elemental bromine has two bromine atoms covalently bonded to each other. Because the atoms on either side of the covalent bond are the same, the electrons in the covalent bond are shared equally, and the bond is a nonpolar covalent bond. Thus, diatomic bromine does not have any intermolecular forces other than London dispersion forces. It is unlikely to be a solid at room temperature unless the dispersion forces are strong enough. Bromine is a liquid at room temperature.

Skill Building: Intermolecular Forces

Question: What intermolecular forces besides dispersion forces, if any, exist in each substance? Are any of these substances solids at room temperature?

1. methylamine (CH₃NH₂)
2. calcium sulfate (CaSO₄)
3. carbon monoxide (CO)

Exercises: Intermolecular Forces

1. List the three common phases in the order you are likely to find them—from lowest temperature to highest temperature.
2. List the three common phases in the order they exist from lowest energy to highest energy.
3. List these intermolecular interactions from weakest to strongest: London forces, hydrogen bonding, and ionic interactions.
4. List these intermolecular interactions from weakest to strongest: covalent network bonding, dipole-dipole interactions, and dispersion forces.
5. What type of intermolecular interaction is predominate in each substance?
water
A. (H₂O)sodium sulfate
B. (Na₂SO₄)decane
C. (C₁₀H₂₂)
6. What type of intermolecular interaction is predominate in each substance?
A. diamond (C, crystal)
B. helium (He)
C. ammonia (NH₃)
7. Explain how a molecule like carbon dioxide (CO₂) can have polar covalent bonds but be nonpolar overall.
8. Sulfur dioxide (SO₂) has a formula similar to that of carbon dioxide (see Exercise 7) but is a polar molecule overall. What can you conclude about the shape of the SO₂ molecule?
9. What are some of the physical properties of substances that experience covalent network bonding?
10. What are some of the physical properties of substances that experience only dispersion forces?

Exercises: Intermolecular Forces – Odd Answers

1. solid, liquid, and gas
3. London forces, hydrogen bonding, and ionic interactions
5.
 - A. hydrogen bonding
 - B. ionic interactions
 - C. dispersion forces
7. The two covalent bonds are oriented in such a way that their dipoles cancel out.
9. very hard, high melting point

Section 5.7: Recognizing and Drawing Organic Molecules

As noted in section 5.1, organic compounds are compounds that contain carbon and hydrogen. Another notable feature of organic molecules is that they are quite complex and contain many atoms of carbon and hydrogen as well as other heteroatoms (atoms other than carbon or hydrogen) that are held together through covalent bonding. The most common heteroatoms that will be found in organic molecules include oxygen, nitrogen, sulfur, phosphorous, and occasionally halides (Cl, Br, and I). Since they can be quite complex, it is useful to discuss the many different ways that organic compounds can be represented/drawn.

Molecular Formula

A **molecular formula** is the simplest way to represent a compound by counting up all of the different types of atoms and listing them in order. For example, the sugar glucose, contains 6 carbons, 12 hydrogens, and 6 oxygens. The molecular formula would then be written as $C_6H_{12}O_6$. By convention, carbon is listed first, hydrogen second, followed by oxygen, nitrogen, sulfur, phosphorus, and finally any halogens. However, for organic chemistry, molecular formulae don't provide much information. They simply provide the numbers of each type of atom present in the molecule, but they tell you nothing about

the way the atoms are joined together in space. For example, two molecules might have the same molecular formula, but a different arrangement of the atoms bonded in space, as is the case for the two sugars glucose and fructose. Both sugars have the molecular formula of $C_6H_{12}O_6$. However, you can see from Figure 5.16, that they are different molecules with different properties, because the atoms are linked together in a different order. Molecules that share the same molecular formula but have their atoms bonded in a different order are called **isomers**. Due to the complexity of isomer structures, molecular formulae not as often used in organic chemistry, because they do not give useful information about the bonding order within the molecule.

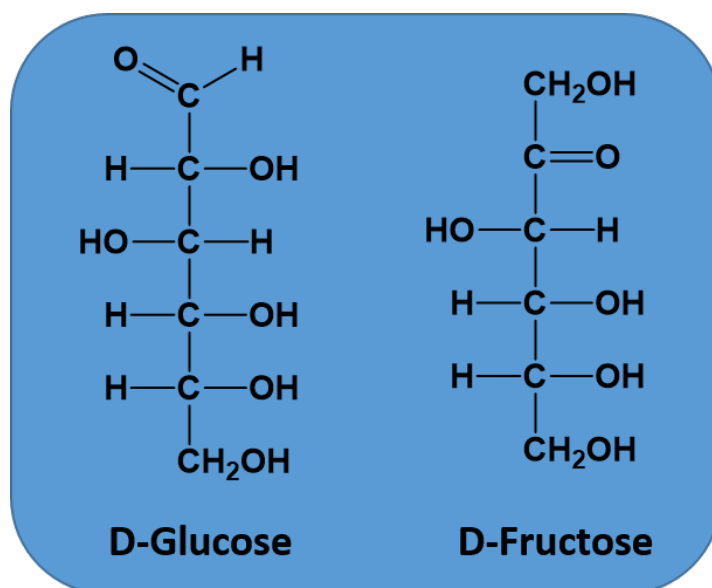

Figure 5.16 Structural Isomers. When molecules, such as D-Glucose and D-Fructose, share the same molecular formula, but have a different atomic bonding order they are called structural isomers.

Structural formulae and 3-dimensional models

A structural formula shows how the various atoms are bonded, and can be more useful than only writing the molecular formula for a compound. There are various ways of drawing structural formulae and you will need to be familiar with all of them. They include the **displayed formula**, **condensed formulas**, and **line structures**.

Displayed formulae

A displayed formula shows all the bonds in the molecule as individual lines with each atom written at the end of each line using its elemental abbreviation from the periodic table. The structures of $C_6H_{12}O_6$, above, are all written in displayed formulae. You need to remember that each line represents a pair of shared electrons. For example, figure 5.17 below depicts the displayed formula of methane next to the three-dimensional representations.

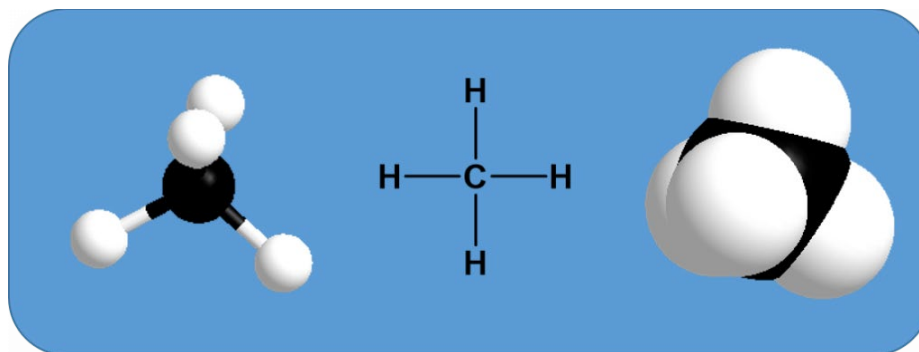
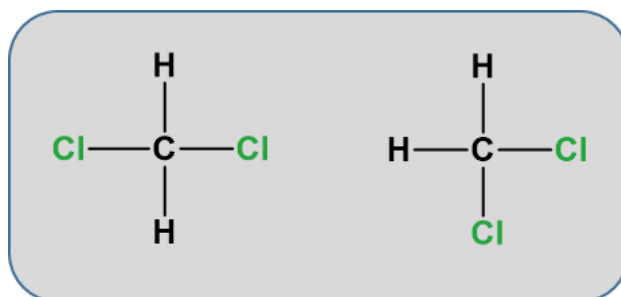

Figure 5.17: Three different representations of CH₄ On the left is the ball and stick model, in the center is the displayed formula, and to the right is the space-filling model.

Notice that the displayed formula of methane does not represent the 3-D shape of the molecule shown in the space-filling diagram on the right. Methane isn't flat with 90° bond angles. This mismatch between what you draw and what the molecule actually looks like can lead to problems if you aren't careful. Thus, for organic chemistry, it is important to begin thinking about the structures in their 3-D form. The more you practice, the more you will be able to visualize and turn the molecule around in your head. For example, consider the simple molecule with the molecular formula CH_2Cl_2 . You might think that there were two different ways of arranging these atoms if you drew a displayed formula.



But these two structures are actually exactly the same. When atoms are sharing electrons with other atoms, they tend to take on three dimensional spatial relationships that keep the electrons in shared pairs as far away as possible from other electrons in shared pairs. This tendency is called valence shell electron pair repulsion theory or VESPR. Due to this tendency, since carbon forms four bonds, it will take on a tetrahedral confirmation where each bond angle is 109° . The molecule is not flat, in the plane of the paper.

One structure is in reality a simple rotation of the other one. Consider a slightly more complicated molecule, C_2H_5Cl . The displayed formula could be written as either of these:

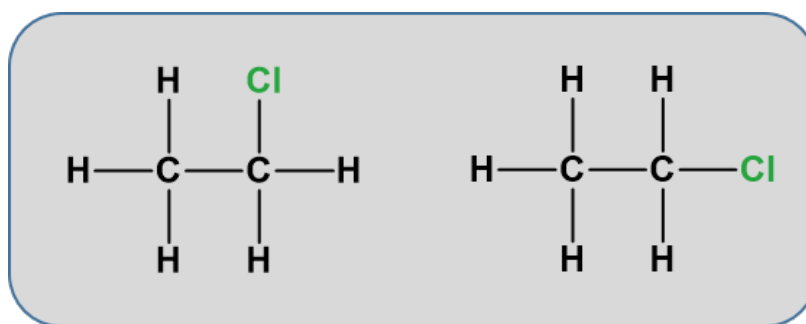

But, again these are exactly the same.

As you continue to practice drawing out structural formulae, you will become better at recognizing and distinguishing between isomers that are truly different from one another, and versions of the same molecule written drawn from different 3-dimensional perspectives.

Condensed formulae

For anything other than the most simple molecules, drawing a fully displayed formula can be cumbersome and take up too much space - especially all the carbon-hydrogen bonds. You can simplify - or **condense** - the formula by writing, for example, CH_3 or CH_2 instead of showing all the C-H bonds. For example, ethanoic ($C_2H_4O_2$) acid can be shown in a fully displayed form, a partially condensed form and a fully condensed form.

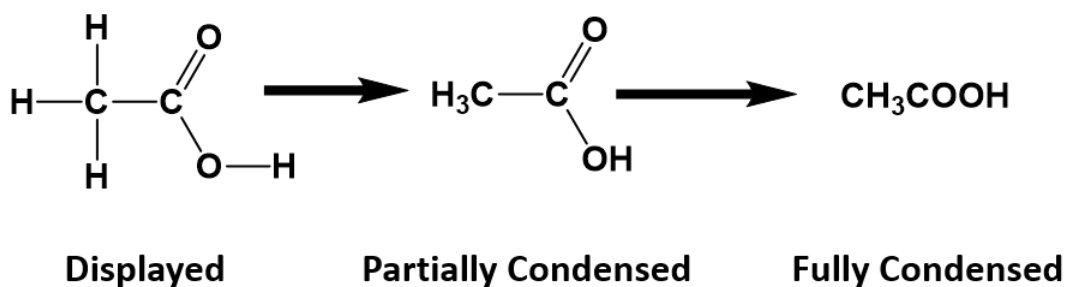

Notice that the partially condensed structure still provides a very clear picture of where each of the atoms is bonded in space. However, with the fully condensed structure, it can be challenging to accurately see the bonding patterns. The fully condensed form does contain more information about bonding order than the molecular formula, such that the atoms that are directly bonded to a neighboring atom are placed adjacent to that atom in the condensed form, rather than a simple tallying of the total atom species as in the molecular formula.

By working backwards, we can use the condensed structure of ethanoic acid as an example to recreate the partially condensed structure. When looking at the first carbon position, it is apparent that there are three hydrogens and one carbon bound to the first carbon:

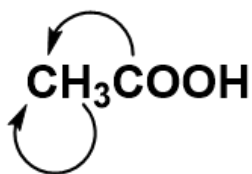

Note that this satisfies the octet rule for the first carbon (four bonds to other atoms). The three hydrogens are also complete with their single bonds to the first carbon. The second carbon has now been assigned one bond to the first carbon. We need to assign the remaining three bonds.

From the condensed formula, it is clear that the first oxygen is attached to the second carbon, however, after that, we become unsure about the position of the second oxygen.

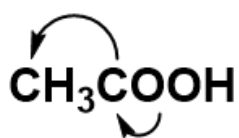

We can clearly deduce that the last hydrogen atom is bound to the second oxygen, as it is placed in that position. However, because oxygen can form two bonds, we can't be sure based on the condensed structure alone, that the second oxygen is bound to the second carbon or to the first oxygen.

When you are unsure of which atom is bonded to which, it is best to draw out the potential structures and evaluate them for their potential correctness.

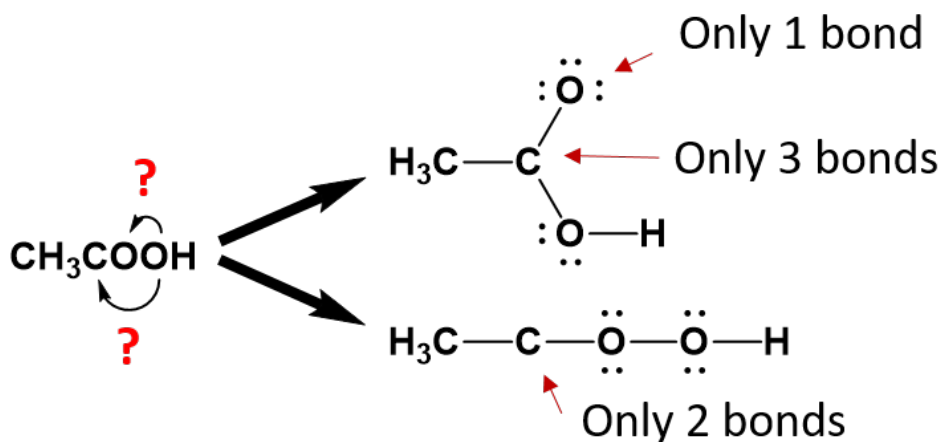

From the analysis of the potential structures above, it is clear that neither structure satisfies the octet rule for one or more atoms within the molecule as currently written. However, the lower structure is less satisfactory than the upper structure, as the second carbon is missing 2 covalent bonds while all of the other atoms have satisfied the octet bonding requirements. In the upper diagram, both the second carbon and the first oxygen atom are lacking one bond. This structure can easily satisfy the octet rule by placing a double bond between carbon 2 and oxygen 1 within the molecule. Whereas, a solution for the missing two carbon bonds for the second carbon in the lower structure is not easily remedied. Thus, the upper structure is a more probable structure than the lower structure with the addition of the double bond between the carbon and the oxygen.

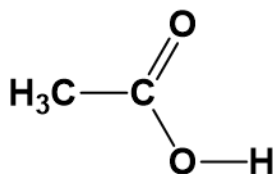

While condensed structures are easier to write than displayed or partially condensed structures they can prove to be a little more challenging to determine the three dimensional bonding pattern of the atoms.

Line or Skeletal Formulae

In a line or skeletal formula, all the hydrogen atoms are not shown and all the carbons are not labeled but rather are indicated at the end or bend in every line, leaving just a carbon skeleton with functional groups attached to it. Any heteroatoms (any other atom than carbon or hydrogen) and hydrogens attached to heteroatoms are shown in condensed

form. For example, the displayed structure, partially condensed structure and the line formula for 2-butanol ($C_4H_{10}O$) look like this:

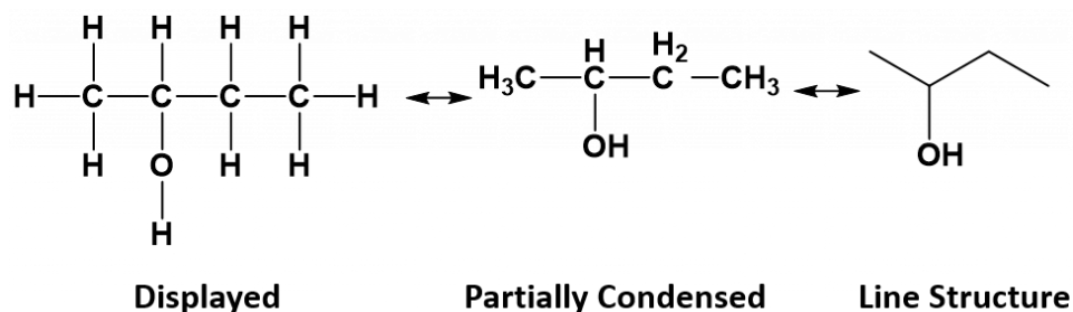

In a line or skeletal diagram, the following assumptions can be made:

- there is a carbon atom at each line junction and at the end of each line.
- there are enough hydrogen atoms attached to each carbon to make the total number of bonds on that carbon equal to 4.
- all heteroatoms (and hydrogens attached to heteroatoms) are shown in condensed format on the skeletal structure.

Within organic chemistry and biochemistry, scientists tend to use a combination of these different formats to represent chemical structures. It is important to become familiar with drawing and interpreting all the different possible representations.

How to draw structural formulae in 3-dimensions

There are occasions when it is important to be able to show the precise 3-D arrangement in parts of some molecules when using a structural representation. To do this, the bonds are shown using conventional symbols:

- Bond is in the plane of the paper
- ||||| Bond is going back into the paper away from you
- ▶ Bond is coming out of the paper towards you

For example, you might want to show the 3-D arrangement of the groups around the carbon which has the $-OH$ group in 2-butanol.

Example: 2-butanol

The partially condensed structure for 2-butanol is:

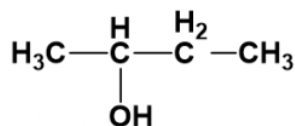

To show the 3-D positioning of the bonds around the first carbon, the structure can be rewritten as:

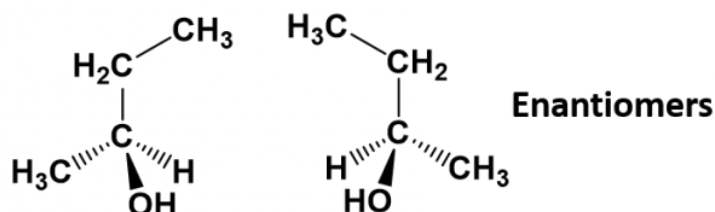

As we will discuss in the next section, displaying the 3-D positioning of atoms within a molecule can be very important for defining the overall structure and function of a molecule.

While the above atoms look identical, they actually are not! They are mirror images of each other, however, if you tried to superimpose one molecule on top of the other molecule, you would find that you would not be able to do so. Molecules that are mirror images of each other, but are not superimposable are defined as a special type of isomer called an **enantiomer**.

Drawing abbreviated organic structures

Often when drawing organic structures, chemists find it convenient to use the letter 'R' to designate part of a molecule outside of the region of interest. If we just want to refer in general to a functional group without drawing a specific molecule, for example, we can use 'R groups' to focus attention on the group of interest:



a primary alcohol

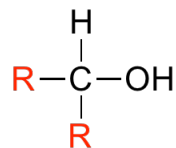

a secondary alcohol

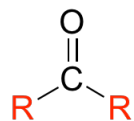

a ketone

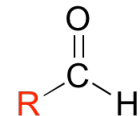

an aldehyde

The R group is a convenient way to abbreviate the structures of large biological molecules, especially when we are interested in something that is occurring specifically at one location on the molecule. For example, in chapter 15 when we look at biochemical oxidation-reduction reactions involving the flavin molecule, we will abbreviate a large part of the flavin structure (ie. R = FAD) which does not change at all in the reactions of interest:

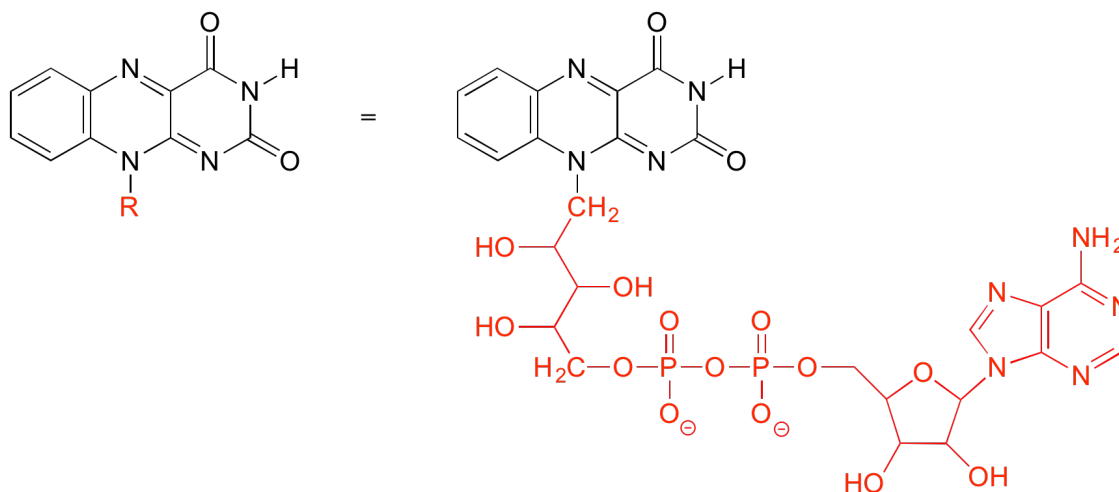

flavin adenine dinucleotide (FAD)

As an alternative, we can use a 'break' symbol to indicate that we are looking at a small piece or section of a larger molecule. This is used commonly in the context of drawing groups on large polymers such as proteins or DNA.

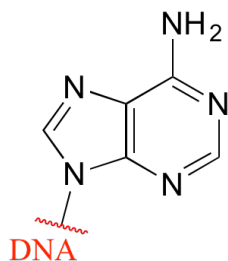

an adenine base in DNA

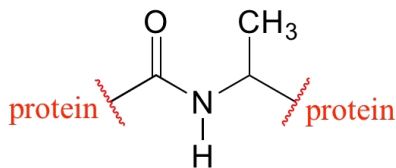

a small section of a protein

Finally, R groups can be used to concisely illustrate a series of related compounds, such as the family of penicillin-based antibiotics.

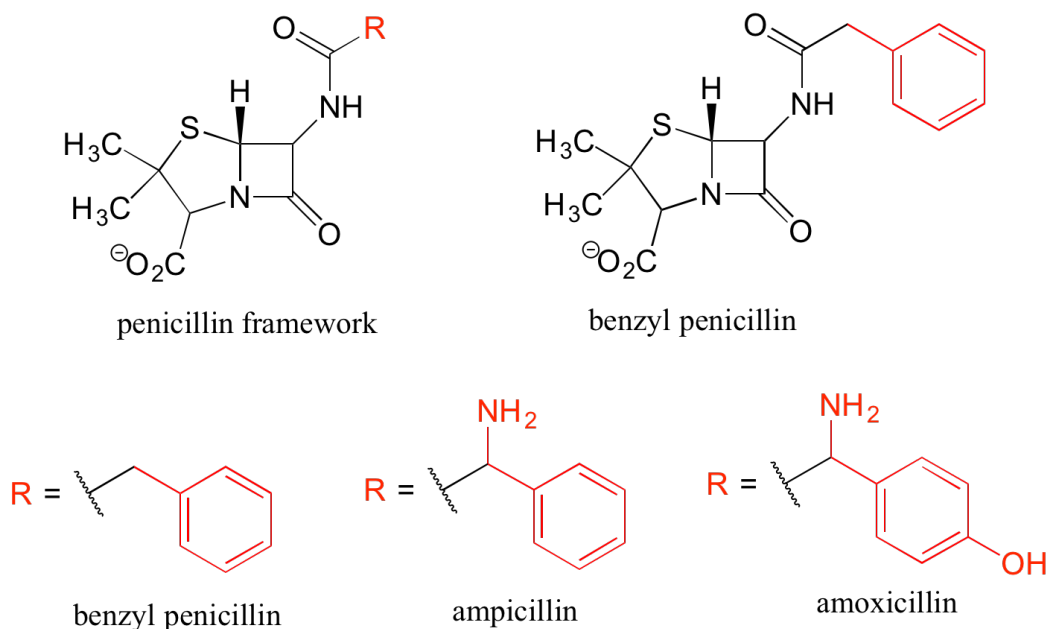

Using abbreviations appropriately is a very important skill to develop when studying organic chemistry in a biological context, because although many biomolecules are very large and complex (and take forever to draw!), usually we are focusing on just one small part of the molecule where a change is taking place.

As a rule, **you should never abbreviate any atom involved in a bond-breaking or bond-forming event that is being illustrated:** only abbreviate that part of the molecule which is not involved in the reaction of interest.

For example, carbon #2 in the reactant/product below most definitely is involved in bonding changes, and therefore should not be included in the 'R' group.

Carbon #2 is involved in reaction events - do **not** include in abbreviation!

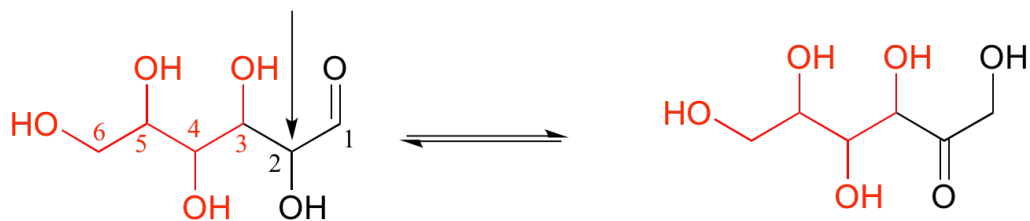

appropriate abbreviation:

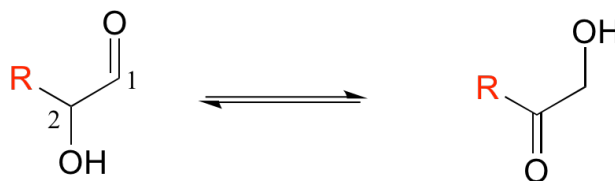

inappropriate abbreviation:



If you are unsure whether to draw out part of a structure or abbreviate it, the safest thing to do is to draw it out.

Section 5.8: Stereoisomers, Enantiomers, and Chirality

As seen in section 5.7, organic chemistry involves infinitely varied structures arising from how the atoms are assembled in 3-dimensional space. Providing only the molecular formula of a compound is often insufficient for defining the compound as many molecular formulas have numerous structural isomers. For example, the molecular formula C_2H_6O , a molecule of only 9 atoms, can refer to dimethyl ether or ethanol, depending on whether the oxygen is in the middle of or at the end of the carbon chain.

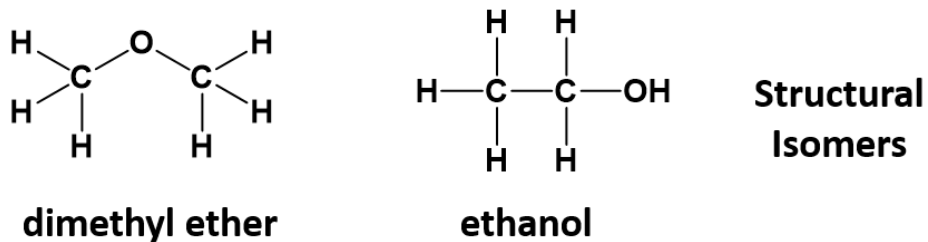

Remember that structural isomers have the same molecular formula, but the order that the atoms are linked together is different, leading to different physical and chemical properties. For example, ethanol is liquid at room temperature, whereas diethyl ether is a gas.

If the atoms of compounds with the same molecular formula are linked together in the same order, but their 3-dimensional arrangement in space differs, they are considered to be a special type of isomer called a **stereoisomer**. The sugar molecules glucose and galactose are stereoisomers. They differ in the spatial position of a single -OH group as indicated in the diagram below:

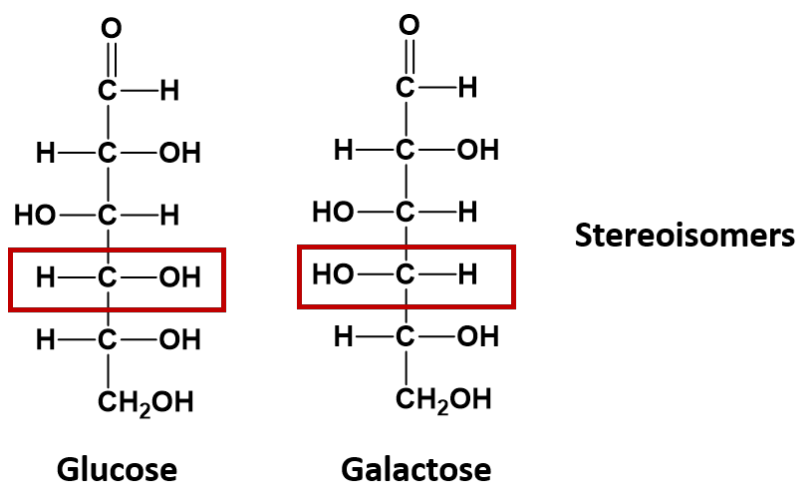

There is a special kind of stereoisomers, called enantiomers, that are mirror images of each other, but are not superimposable. This means that no matter how you turn them in space that you can never put them on top of one another and recover the same compound. One example is 2-butanol which can be drawn as a pair of enantiomers (Fig. 5.18).

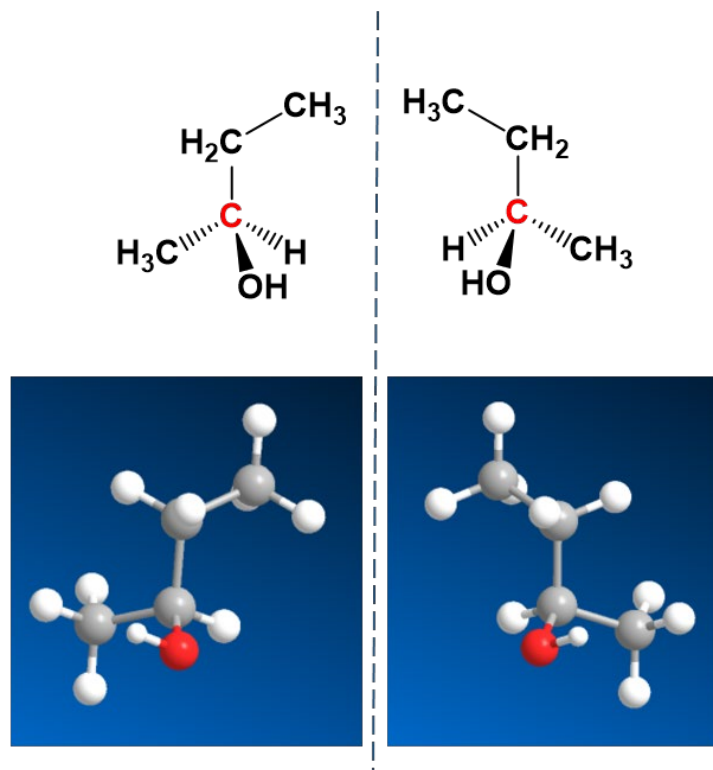

Enantiomers are mirror images that are not superimposable

Figure 5.18: The enantiomers of 2-butanol. The enantiomers are shown in the 3-D structural formula displayed in the top diagram and the ball and stick model in the lower diagram.

Chirality

Enantiomers are said to have the property of **chirality**. **Chirality** is the term that is given to objects that are mirror images but are not superimposable. The term 'chiral' is derived from the Greek word for 'handedness' – ie. right-handedness or left-handedness. Your hands are chiral: your right hand is a mirror image of your left hand, but if you place one hand on top of the other, both palms down, you see that they are not superimposable. (Fig 5.19). Thus chiral objects are mirror images of one another, but cannot be superimposed on top of one another. Carbon becomes chiral when it has four different substituents attached to it. You will notice in the example above that the central carbon has four different groups attached to it: an -OH group, an -H, a -CH₃, and a -CH₂CH₃ group.

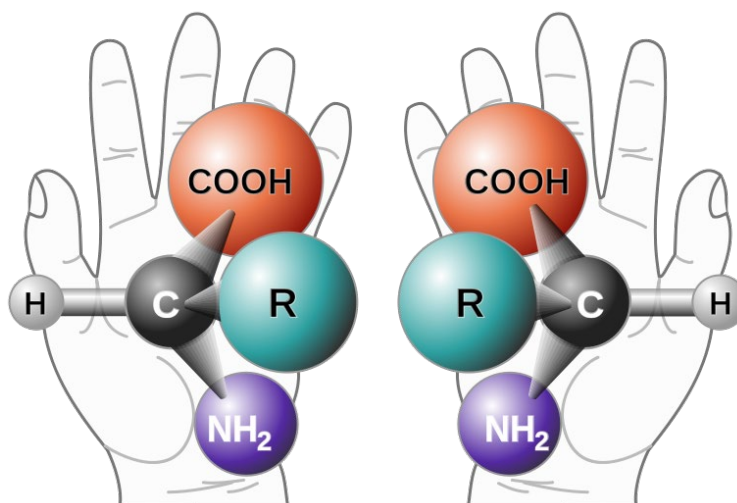

Figure 5.19: The Nature of Chirality. Carbon becomes chiral when it has four different substituents bonded to it. Any way you rotate the molecule on the left, you cannot superimpose it onto the molecule on the right.

Source: [Chirality with hands.jpg](#): Unknown derivative work: -- [περήλιο ©](#) - [Chirality with hands.jpg](#)

Stereoisomers that are not enantiomers, such as glucose and galactose shown above, **do** have chiral centers and are not superimposable, but they are not mirror images of one another. Only stereoisomers that are also mirror images and not superimposable are termed enantiomers. Enantiomers are very hard to separate from one another. They are nearly identical in their physical and chemical properties. They have the same molecular weight, the same polarity, the same melting and boiling points, etc. In fact, enantiomers are so alike that they even share the same name! In Figure 5.14 the two enantiomers of 2-butanol are shown. Both of the molecules are 2-butanol. But they are **not** exactly the same molecule, in the same way that your left shoe is not **exactly** the same as your right. They are non-superimposable mirror images of each other. How do we communicate this difference?

One small difference between enantiomers is the direction that polarized light will rotate when it hits the molecule. One enantiomer will rotate light in the clockwise direction, while the other will rotate it in the counterclockwise direction. The clockwise version is termed 'D' for dextrorotary (or right-handed) and the counterclockwise version is termed 'L' for levorotary (or left-handed). However, light rotation cannot be used in a predictive way to determine the absolute stereo-configuration of a molecule (i.e. you cannot tell which

enantiomer is going to rotate the light to the right or to the left until you actually do the experiment).

Thus, another system is needed to describe the absolute configuration. The Cahn-Ingold-Prelog (CIP) priority system was designed to determine the absolute stereo-configuration of enantiomers as either sinister (S) or rectus (R). In this system, the groups that are attached to the chiral carbon are given priority based on their atomic number (**Z**). Atoms with higher atomic number (more protons) are given higher priority (i.e. $S > P > O > N > C > H$).

For determining the stereochemistry, place the lowest priority group away from you, so that the other three groups are held are facing you. Assign priority to the remaining groups.

The rules for this system of stereochemical nomenclature are, on the surface, fairly simple. We'll use the simple 3-carbon sugar glyceraldehyde as our first example. Try making a model of the stereoisomer of glyceraldehyde shown below. If you don't have a chemistry modeling kit, an easy alternative is to use toothpicks and gumdrops. Be sure that you are making the correct enantiomer!

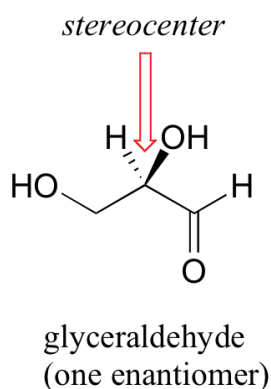

The first thing that we must do is to assign a **priority** to each of the four substituents bound to the **chiral carbon**. In this nomenclature system, the priorities are based on atomic number, with higher atomic numbers having a higher priority. We first look at the atoms that are directly bonded to the chiral carbon: these are H, O (in the hydroxyl), C (in the aldehyde), and C (in the CH₂OH group).

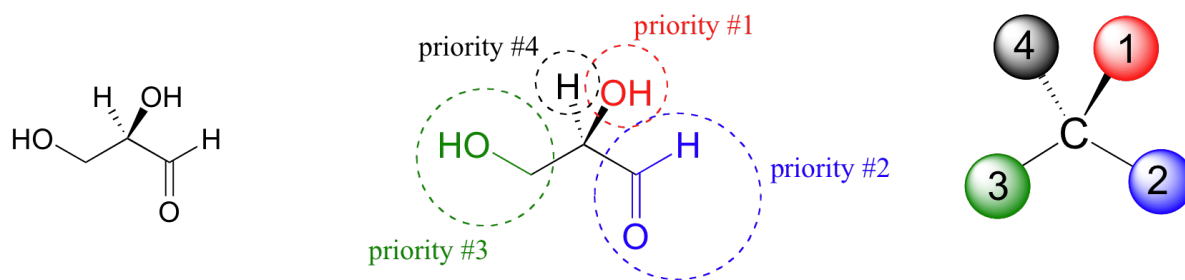

Two priorities are easy: hydrogen, with an atomic number of 1, is the lowest (#4) priority, and the hydroxyl oxygen, with atomic number 8, is priority #1. Carbon has an atomic number of 6. Which of the two 'C' groups is priority #2, the aldehyde (CHO) or the alcohol (CH₂OH)? To determine this, we move one more bond away from the stereocenter: for the aldehyde we have a **double** bond to an oxygen, while on the CH₂OH group we have a **single** bond to an oxygen. If the atom is the same, double bonds have a higher priority than single bonds. Therefore, the aldehyde group is assigned #2 priority and the CH₂OH group the #3 priority. With our priorities assigned, we next make sure that the #4 priority group (the hydrogen) is pointed back away from ourselves, into the plane of the page (it is already).

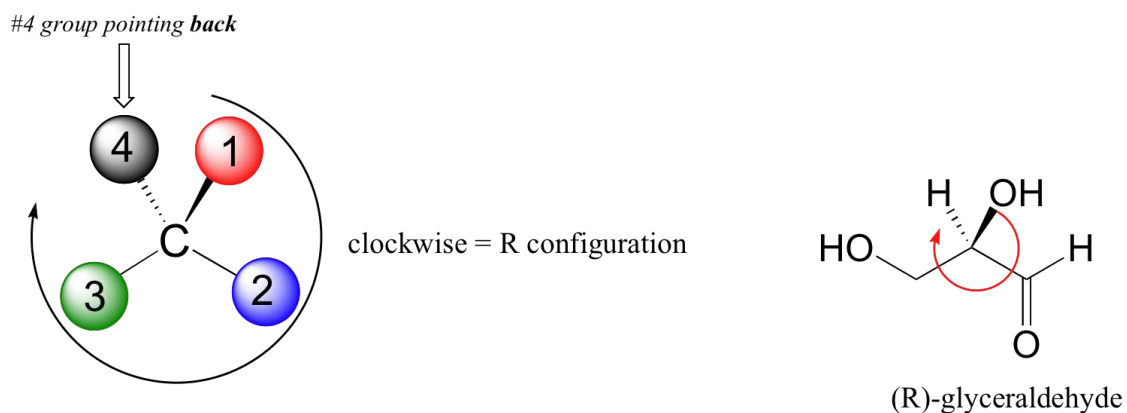

Then, we trace a circle defined by the #1, #2, and #3 priority groups, in increasing order. For our glyceraldehyde example, this circle is clockwise, which tells us that this carbon has the 'R' configuration, and that this molecule is (R)-glyceraldehyde. For (S)-glyceraldehyde, the circle described by the #1, #2, and #3 priority groups is counter-clockwise (but first, we must flip the molecule over so that the H is pointing into the plane of the page).

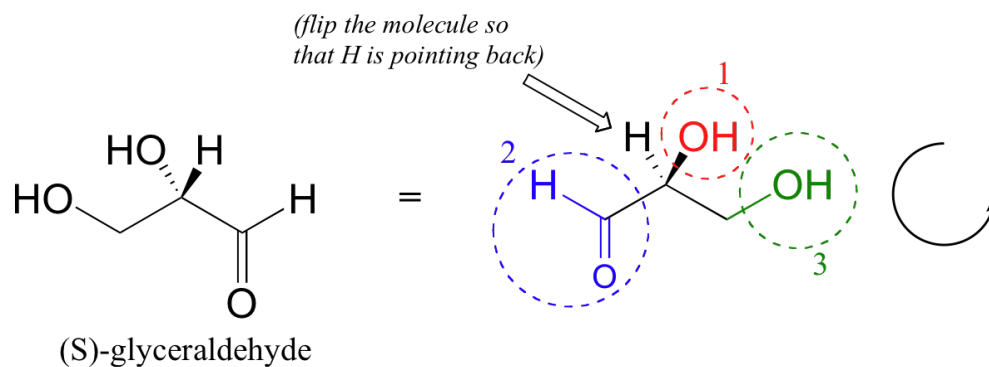

In the case of 2-butanol (Fig 5.20), the first priority and the fourth priority are easy to assign. The -OH is first priority and the -H is fourth priority. How do you assign 2nd and 3rd priority, since both of those atoms are carbon? If the priority is the same for an attached atom, you need to look out to the next level and evaluate priority there. For 2-butanol, one group is -CH₃ and one group is -CH₂CH₃. In the first situation, if we look out to the next level, this carbon is bound to three other hydrogen atoms (all very low priority). In the second situation, the carbon is bound to two hydrogens and one carbon. Since C has a higher priority than H, the -CH₂CH₃ group will have higher priority over the -CH₃ group. Once all of the groups have been assigned priority, you can determine which direction the priority is moving. If it is in the clockwise direction, the molecule is given the 'R' designation. Priority moving in the counterclockwise direction is given the 'S' designation. In our example, the 2-butanol on the left shows priority moving in the counterclockwise direction giving the S-enantiomer. The molecule on the right shows the R-enantiomer with priority moving in the clockwise direction.

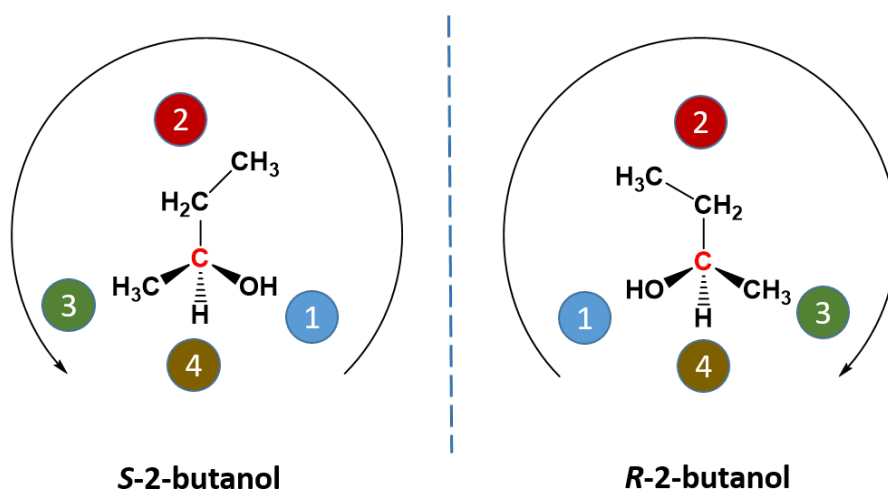
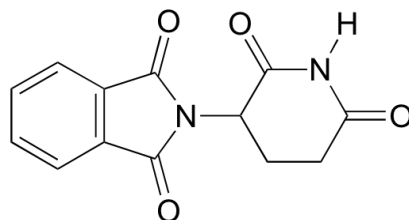

Figure 5.20: Stereochemistry of 2-butanol. The CIP priority system can be used to determine the absolute stereo-conformation of enantiomers

Thalidomide - A Story of Unintended Consequences

Interestingly, enantiomers have the same physical properties and exactly the same chemical properties, **except** when reacting with other chiral molecules. Thus, chiral molecules have potentially drastic differences in physiology and medicine. For example, in the 1960's, a drug called thalidomide was widely prescribed in Western Europe to alleviate morning sickness in pregnant women.



thalidomide

Thalidomide had previously been used in other countries as an antidepressant, and was believed to be safe and effective. It was not long, however, before doctors realized that something had gone horribly wrong: many babies born to women who had taken thalidomide during pregnancy suffered from severe birth defects.



Figure 5.21: Baby born to a mother who had taken thalidomide while pregnant.
(OtisArchives3, CC BY 2.0)

Researchers later realized that the problem lay in the fact that thalidomide was being provided as a mixture of two different isomeric forms, called a racemic mixture.

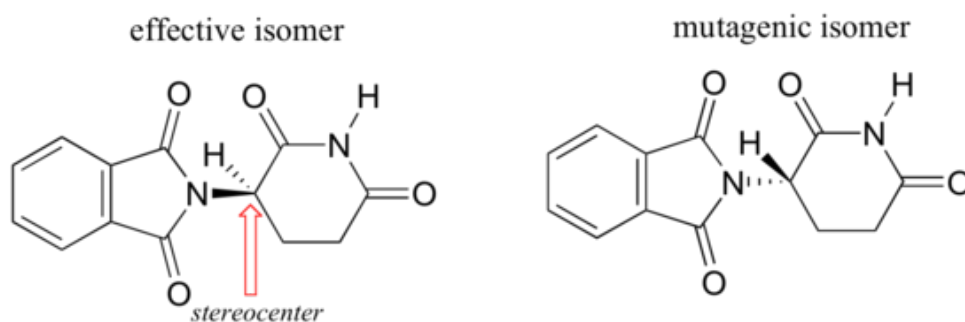

One of the isomers is an effective medication, while the other caused the side effects. Both isomeric forms have the same molecular formula and the same atom-to-atom connectivity, so they are not merely structural isomers. Where they differ is in the arrangement in three-dimensional space about one tetrahedral chiral carbon. Thus, these two forms of thalidomide are enantiomers.

Note that the carbon in question has **four different substituents** (two of these just happen to be connected by a ring structure). Tetrahedral carbons with four different substituent groups are called **stereocenters**.

Practice Question:

Identify the Chiral Carbons in the following molecules

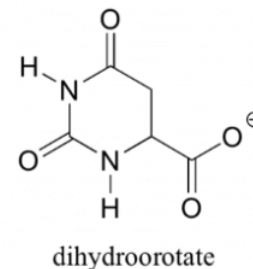
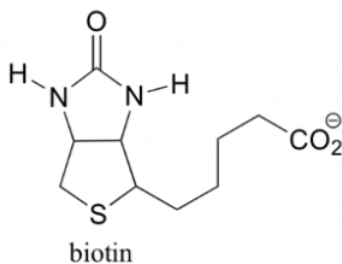
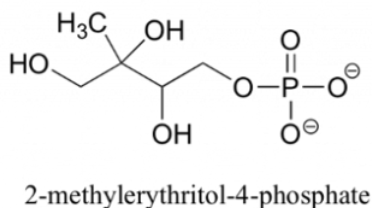
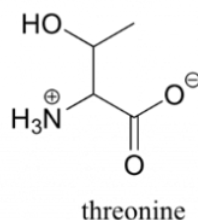
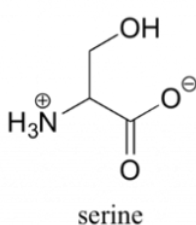
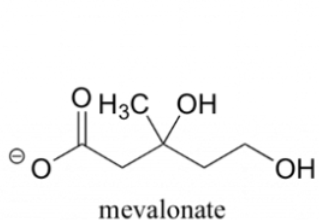

Looking at the structures of what we are referring to as the two isomers of thalidomide, you may not be entirely convinced that they are actually two different molecules. In order to convince ourselves that they are indeed different, let's create a generalized picture of a tetrahedral carbon stereocenter, with the four substituents designated R₁-R₄. The two stereoisomers of our simplified model look like this:

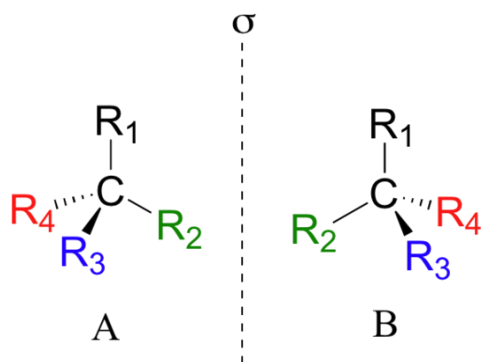

If you look carefully at the figure above, you will notice that molecule A and molecule B are mirror images of each other (the line labeled ' σ ' represents a mirror plane). Furthermore, **they are not superimposable**: if we pick up molecule A, flip it around, and place it next to molecule B, we see that the two structures cannot be superimposed on each other. They are two different molecules!

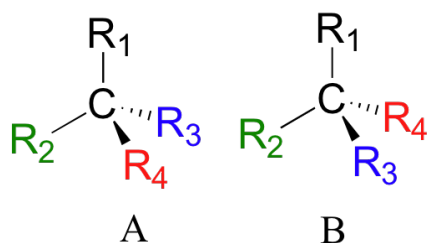

If you make models of the two stereoisomers of thalidomide and do the same thing, you will see that they too are mirror images, and cannot be superimposed (it will help to look at a color version of the figure below).

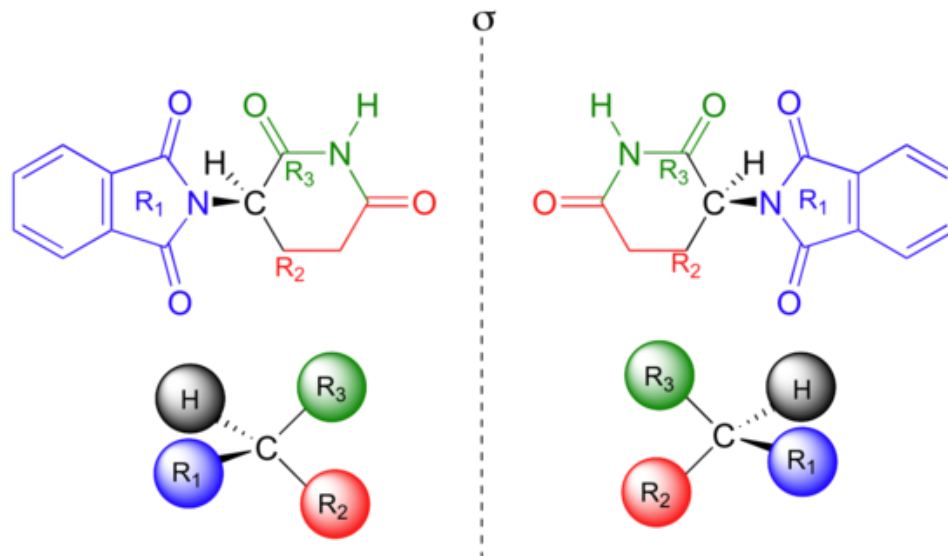

Thalidomide is a **chiral** molecule.

Here are some more examples of chiral molecules that exist as pairs of enantiomers. In each of these examples, there is a single stereocenter, indicated with an arrow. (Many molecules have more than one stereocenter, but we will get to that a little later!)

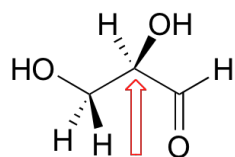

glyceraldehyde

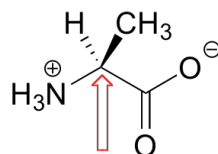
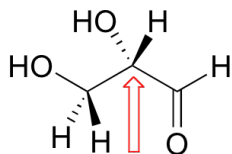

alanine

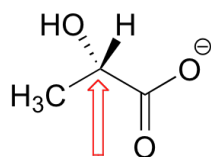
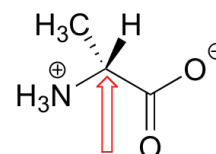

lactate

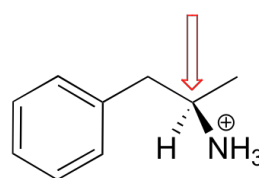
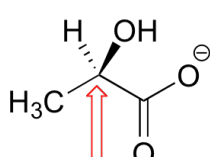

amphetamine

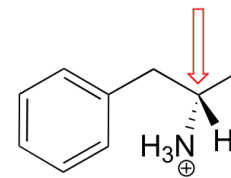

Here are some examples of molecules that are achiral (not chiral). Notice that none of these molecules has a stereocenter (an atom that is bound to four different substituents).

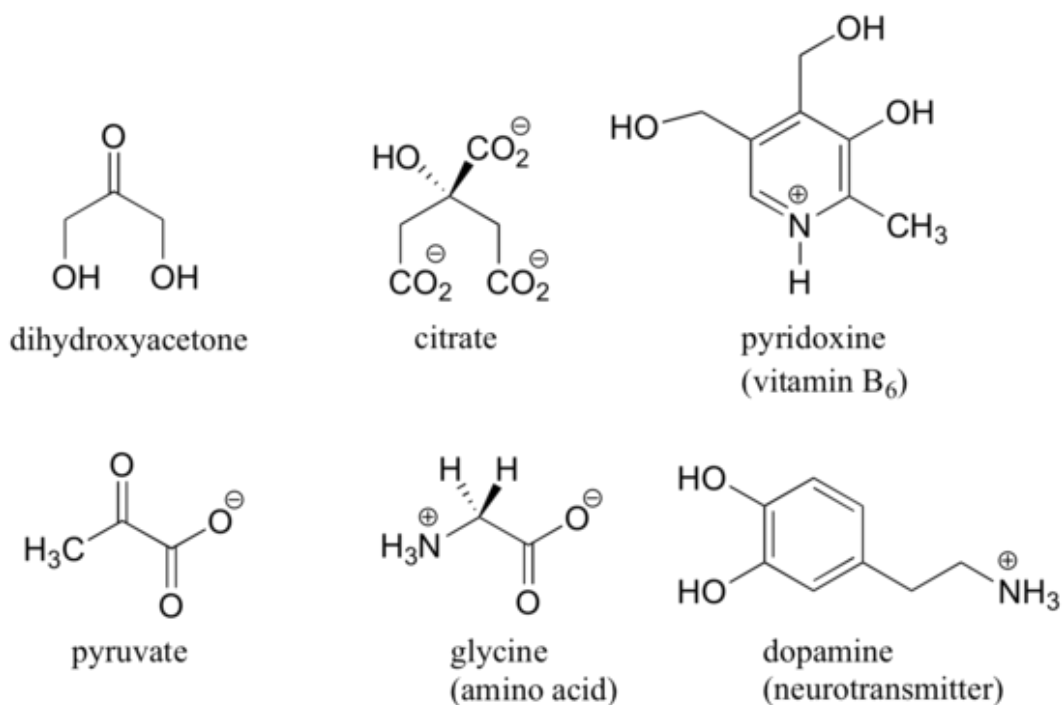

When evaluating a molecule for chirality, it is important to recognize that the use of the dashed/solid wedge drawing does not necessarily mean that the molecule is chiral. Chiral molecules are sometimes drawn without using wedges. Conversely, wedges may be used on carbons that are not stereocenters – look, for example, at the drawings of glycine and citrate in the figure above. Just because you see dashed and solid wedges in a structure, do not automatically assume that you are looking at a stereocenter.

Other elements in addition to carbon can be stereocenters. The phosphorus center of phosphate ion and organic phosphate esters, for example, is tetrahedral, and thus is potentially a stereocenter.

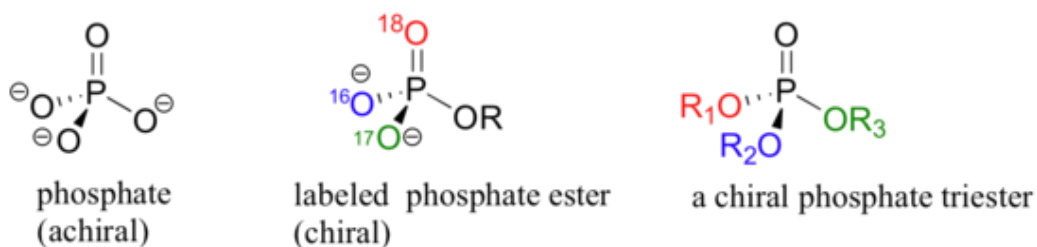

Practice Question:

Label the molecules below as chiral or achiral, and locate all stereocenters

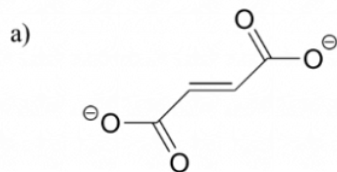

fumarate
(a citric acid cycle intermediate)

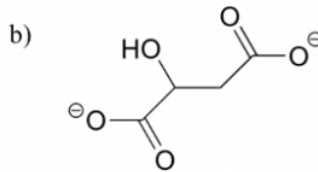

malate
(a citric acid cycle intermediate)

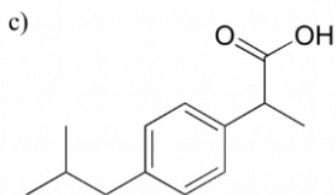

ibuprofen

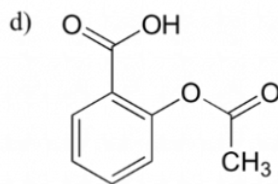

acetylsalicylic acid
(aspirin)

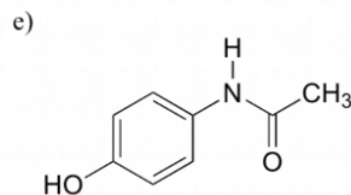

acetaminophen
(active ingredient in Tylenol)

Having trouble visualizing chirality and enantiomers? It may be helpful to watch this [video tutorial](#)

Section 5.9: The Importance of Chirality in Protein Interactions

The thalidomide that was used in the 1960s to treat depression and morning sickness was sold as a 50:50 mixture of both the R and the S enantiomer – this is referred to as a **racemic mixture**. A 'squiggly' bond in a chemical structure indicates a racemic mixture - thus racemic (**R/S**) thalidomide would be drawn as:

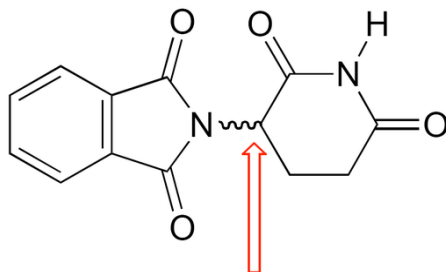

mixture of both R and S configurations at this stereocenter

The problem with racemic thalidomide, as we learned above, is that only the R enantiomer is an effective medicine, while the S enantiomer causes mutations in the developing fetus. How does such a seemingly trivial structural variation lead to such a dramatic (and in this case, tragic) difference in biological activity? Virtually all drugs work by interacting in some way with important proteins in our cells: they may bind to pain receptor proteins to block the transmission of pain signals, for instance, or clog up the active site of an enzyme that is involved in the synthesis of cholesterol. Proteins are chiral molecules, and are very sensitive to stereochemistry: just as a right-handed glove won't fit on your left hand, a protein that is able to bind tightly to (**R**)-thalidomide may not bind well at all to (**S**)-thalidomide (it will help to view a color version of the figure below).

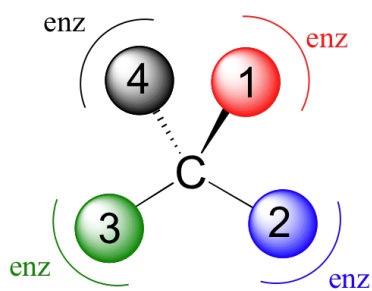

a protein that binds specifically to a chiral molecule . . .

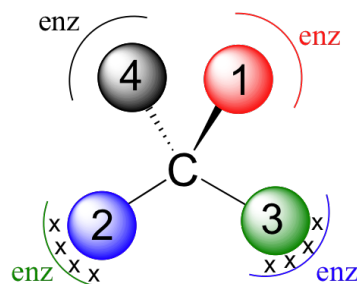

may not bind well at all to a different stereoisomer!

Instead, it seems that (**S**)-thalidomide interacts somehow with a protein involved in the development of a growing fetus, eventually causing the observed birth defects.

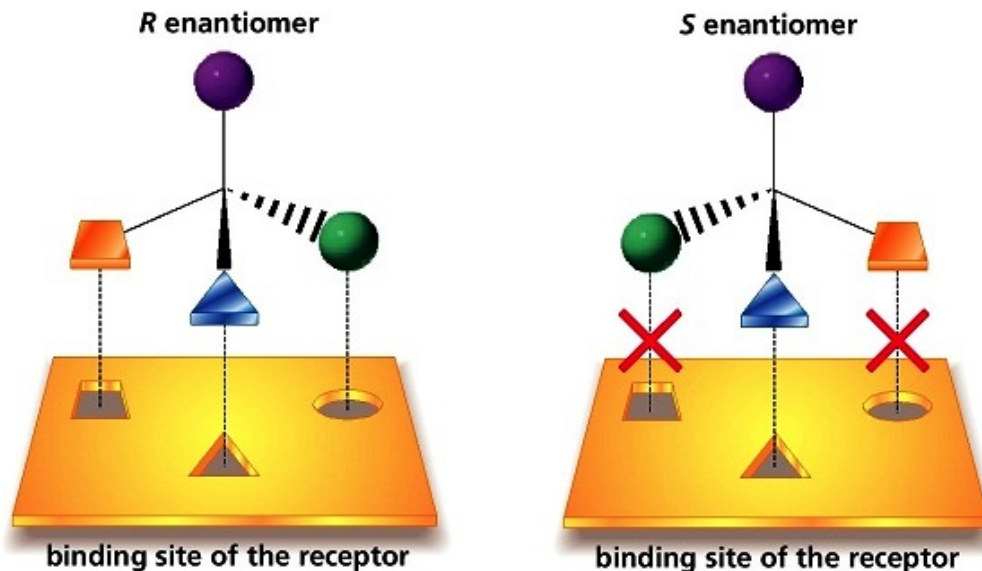
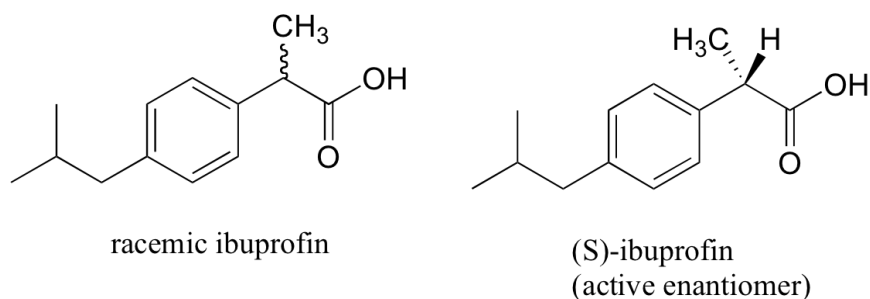

Figure 5.22 Drug binding sites on proteins are stereospecific.

Source: www.kshitij-iitjee.com/Study/Chemistry/Part2/Chapter3/109.jpg

The over-the-counter painkiller ibuprofen is currently sold as a racemic mixture, but only the **S** enantiomer is effective.



Fortunately, the **R** enantiomer does not produce any dangerous side effects, although its presence does seem to increase the amount of time that it takes for (**S**)-ibuprofen to take effect.

You can, with the assistance your instructor, directly experience the biological importance of stereoisomerism. Carvone is a chiral, plant-derived molecule that smells like spearmint in the **R** form and caraway (a spice) in the **S** form.

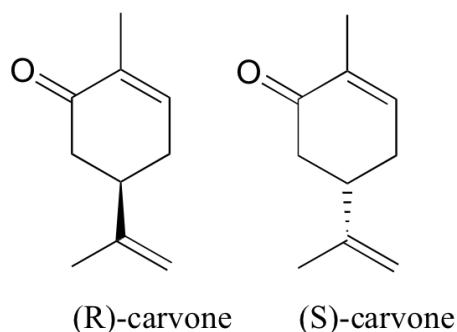

The two enantiomers interact differently with smell receptor proteins in your nose, generating the transmission of different chemical signals to the olfactory center of your brain.

Section 5.10: Common Organic Functional Groups

The number of known organic compounds is a quite large. In fact, there are many times more organic compounds known than all the other (inorganic) compounds discovered so far, about 7 million organic compounds in total. Fortunately, organic chemicals consist of a relatively few similar parts, combined in different ways, that allow us to predict how a compound we have never seen before may react, by comparing how other molecules containing the same types of parts are known to react.

These parts of organic molecules are called functional groups and are made up from specific bonding patterns with the atoms most commonly found in organic molecules (C, H, O, N, S, and P). The identification of functional groups and the ability to predict reactivity based on functional group properties is one of the cornerstones of organic chemistry.

Functional groups are specific atoms, ions, or groups of atoms having consistent properties. A functional group makes up part of a larger molecule.

For example, -OH, the hydroxyl group that characterizes alcohols, is an oxygen with a hydrogen attached. It could be found on any number of different molecules.

Just as elements have distinctive properties, functional groups have characteristic chemistries. An -OH functional group on one molecule will tend to react similarly, although perhaps not identically, to an -OH on another molecule.

Organic reactions usually take place at the functional group, so learning about the reactivities of functional groups will prepare you to understand many other things about organic chemistry.

Functional groups are structural units within organic compounds that are defined by specific bonding arrangements between specific atoms. The structure of capsaicin, the fiery compound found in hot peppers, incorporates several functional groups, labeled in the figure below and explained throughout this section.

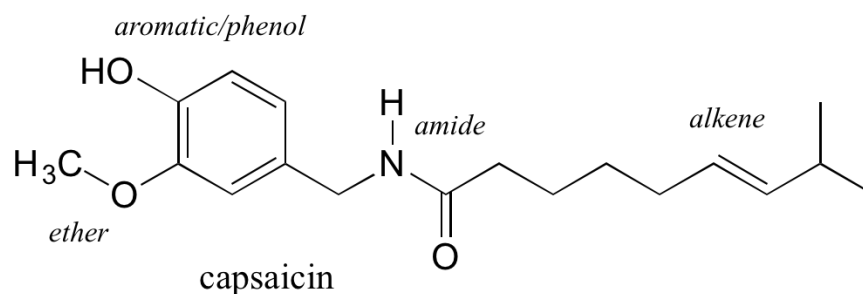

As we progress in our study of organic chemistry, it will become extremely important to be able to quickly recognize the most common functional groups, because **they are the key structural elements that define how organic molecules react**. For now, we will only worry about drawing and recognizing each functional group, as depicted by Lewis and line structures. Much of the remainder of your study of organic chemistry will be taken up with learning about how the different functional groups behave in organic reactions. Below is a brief introduction to the major organic functional groups.

Alkanes

The 'default' in organic chemistry (essentially, the **lack** of any functional groups) is given the term **alkane**, characterized by single bonds between carbon and carbon, or between carbon and hydrogen. Methane, CH₄, is the natural gas you may burn in your furnace. Octane, C₈H₁₈, is a component of gasoline.

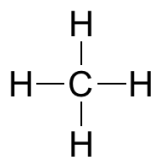

methane

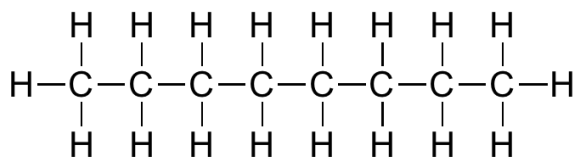

||

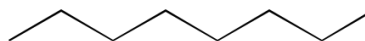

octane

Alkenes and Alkynes

Alkenes (sometimes called olefins) have carbon-carbon double bonds, and alkynes have carbon-carbon triple bonds. Ethene, the simplest alkene example, is a gas that serves as a cellular signal in fruits to stimulate ripening. (If you want bananas to ripen quickly, put them in a paper bag along with an apple - the apple emits ethene gas (also called ethylene), setting off the ripening process in the bananas). Ethyne, commonly called acetylene, is used as a fuel in welding blow torches.

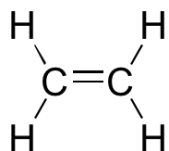

ethene
(an alkene)

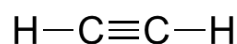

ethyne
(an alkyne)

Many alkenes can take two geometric forms: **cis** or **trans**. The **cis** and **trans** forms of a given alkene are different isomers with different physical properties because there is a very high energy barrier to rotation about a double bond. In the example below, the difference between **cis** and **trans** alkenes is readily apparent.

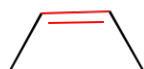
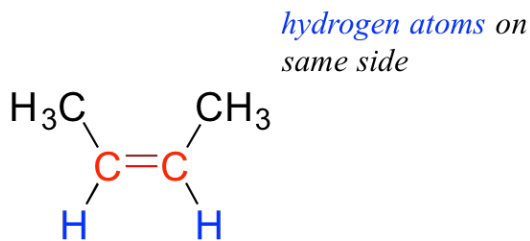

cis-alkene

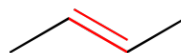
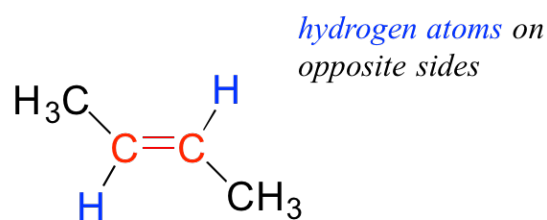

trans-alkene

Alkanes, alkenes, and alkynes are all classified as hydrocarbons, because they are composed solely of carbon and hydrogen atoms. Alkanes are said to be saturated hydrocarbons, because the carbons are bonded to the maximum possible number of hydrogens - in other words, they are '**saturated**' with hydrogen atoms. The double and triple-bonded carbons in alkenes and alkynes have fewer hydrogen atoms bonded to them - they are thus referred to as unsaturated hydrocarbons.

Aromatics

The aromatic group is exemplified by benzene (which used to be a commonly used solvent on the organic lab, but which was shown to be carcinogenic), and naphthalene, a compound with a distinctive 'mothball' smell. Aromatic groups are planar (flat) ring structures, and are widespread in nature.

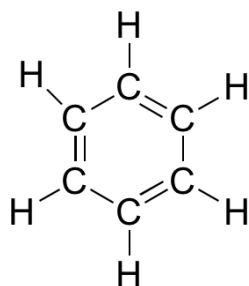

=

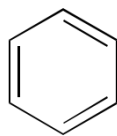

benzene

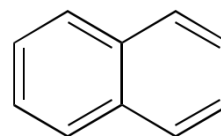

naphthalene

Alkyl Halides

When the carbon of an alkane is bonded to one or more halogens, the group is referred to as an alkyl halide or haloalkane. Chloroform is a useful solvent in the laboratory, and was one of the earlier anesthetic drugs used in surgery. Chlorodifluoromethane was used as a refrigerant and in aerosol sprays until the late twentieth century, but its use was discontinued after it was found to have harmful effects on the ozone layer. Bromoethane is a simple alkyl halide often used in organic synthesis. Alkyl halides groups are quite rare in biomolecules.

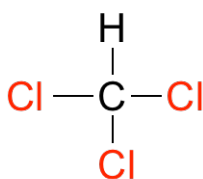

trichloromethane
(chloroform)

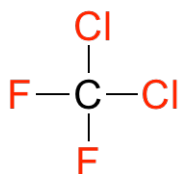

dichlorodifluoromethane
(Freon-12)

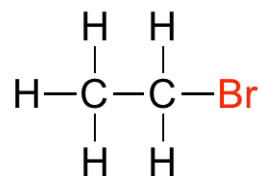

bromoethane

Alcohols, Phenols, and Thiols

In the **alcohol** functional group, a carbon is single-bonded to an OH group (the OH group, when it is part of a larger molecule, is referred to as a **hydroxyl group**). Except for methanol, all alcohols can be classified as primary, secondary, or tertiary. In a primary alcohol, the carbon bonded to the OH group is also bonded to only one other carbon. In a secondary alcohol and tertiary alcohol, the carbon is bonded to two or three other carbons, respectively. When the hydroxyl group is **directly** attached to an aromatic ring, the resulting group is called a phenol. The sulfur analog of an alcohol is called a thiol (from the Greek **thio**, for sulfur).

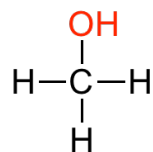

methanol

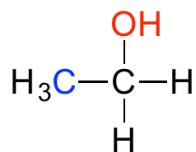

primary alcohol

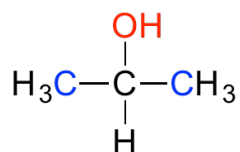

secondary alcohol

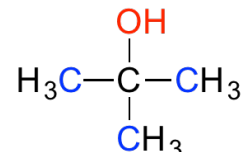

tertiary alcohol

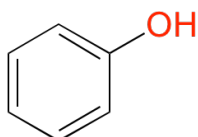

phenol

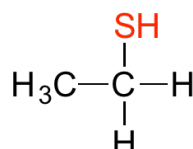

thiol

Note that the definition of a phenol states that the hydroxyl oxygen must be **directly** attached to one of the carbons of the aromatic ring. The compound below, therefore, is **not** a phenol - it is a primary alcohol.

*hydroxyl is not attached to carbon
in aromatic ring*

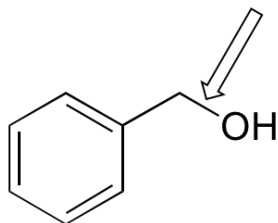

primary alcohol
(*not* a phenol)

The distinction is important, because there is a significant difference in the reactivity of alcohols and phenols

Ethers and Sulfides

In an ether functional group, an oxygen is bonded to two carbons. Below is the structure of diethyl ether, a common laboratory solvent and also one of the first compounds to be used as an anesthetic during operations. The sulfur analog of an ether is called a **thioether** or **sulfide**.

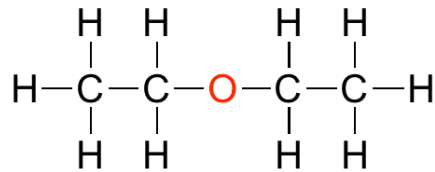

||

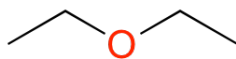

an ether

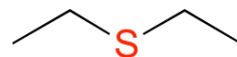

a sulfide

Amines

Amines are characterized by nitrogen atoms with single bonds to hydrogen and carbon. Just as there are primary, secondary, and tertiary alcohols, there are primary, secondary, and tertiary amines. Ammonia is a special case with no carbon atoms.

One of the most important properties of amines is that they are basic, and are readily protonated to form ammonium cations. In the case where a nitrogen has four bonds to carbon (which is somewhat unusual in biomolecules), it is called a quaternary ammonium ion.

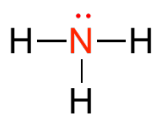

ammonia

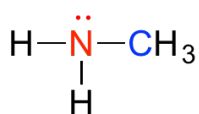

a primary amine



a secondary amine

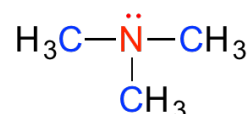

a tertiary amine

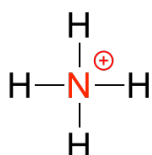

ammonium ion

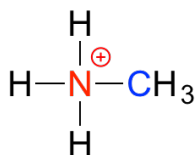

a primary ammonium ion

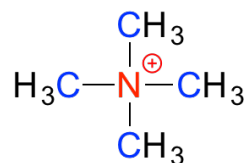

a quaternary ammonium ion

Note: Do not be confused by how the terms 'primary', 'secondary', and 'tertiary' are applied to alcohols and amines - the definitions are different. In alcohols, what matters

is how many other carbons the alcohol **carbon** is bonded to, while in amines, what matters is how many carbons the **nitrogen** is bonded to.

carbon is bonded to three carbons

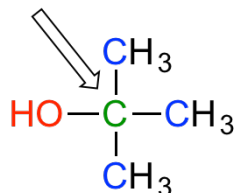

a tertiary alcohol

nitrogen is bonded to one carbon

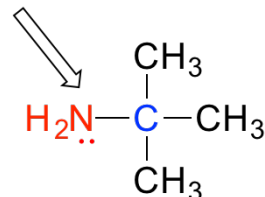

a primary amine

Organic Phosphates

Phosphate and its derivative functional groups are ubiquitous in biomolecules. Phosphate linked to a single organic group is called a **phosphate ester**; when it has two links to organic groups it is called a phosphate diester. A linkage between two phosphates creates a phosphate anhydride.

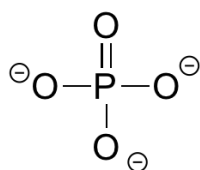

phosphate

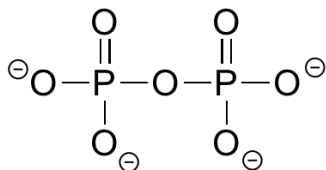

a phosphate anhydride

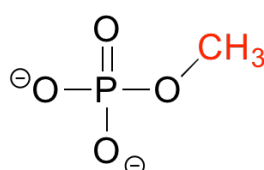

a phosphate ester

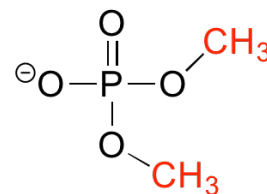

a phosphate diester

Aldehydes and Ketones

There are a number of functional groups that contain a carbon-oxygen double bond, which is commonly referred to as a carbonyl. Ketones and aldehydes are two closely related carbonyl-based functional groups that react in very similar ways. In a ketone, the carbon atom of a carbonyl is bonded to two other carbons. In an **aldehyde**, the carbonyl carbon is bonded on one side to a hydrogen, and on the other side to a carbon. The exception to this definition is formaldehyde, in which the carbonyl carbon has bonds to two hydrogens.

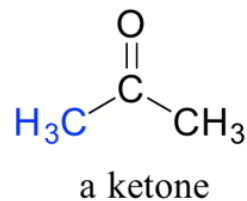
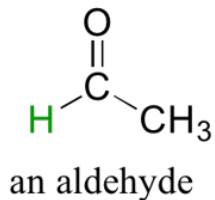
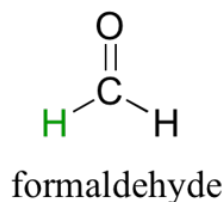

Carboxylic Acids and Their Derivatives

When a carbonyl carbon is bonded on one side to a carbon (or hydrogen) and on the other side to an oxygen, nitrogen, or sulfur, the functional group is considered to be one of the 'carboxylic acid derivatives', a designation that describes a set of related functional groups. The main member of this family is the **carboxylic acid** functional group, in which the carbonyl is bonded to a hydroxyl group. The carboxylate ion form has donated the H^+ to the solution. Other derivatives are carboxylic esters (usually just called 'esters'), **thioesters**, **amides**, **acyl phosphates**, **acid chlorides**, and **acid anhydrides**. With the exception of acid chlorides and acid anhydrides, the carboxylic acid derivatives are very common in biological molecules and/or metabolic pathways and will be discussed in further details in a later chapter.

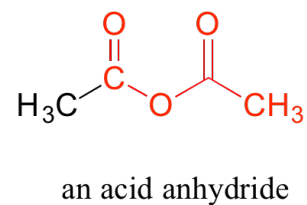
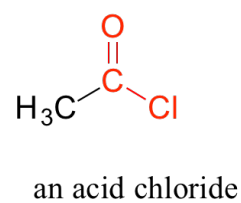
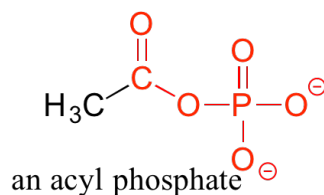
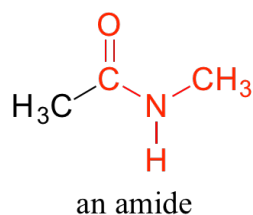
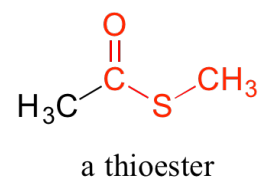
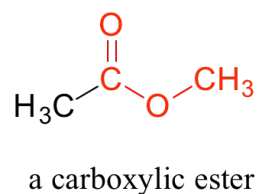
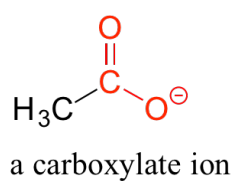
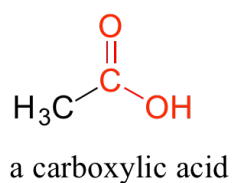

Practice Recognizing Functional Groups in Molecules

A single compound often contains several functional groups, particularly in biological organic chemistry. The six-carbon sugar molecules glucose and fructose, for example, contain aldehyde and ketone groups, respectively, and both contain five alcohol groups. A compound with several alcohol groups is often referred to as a 'polyol'.

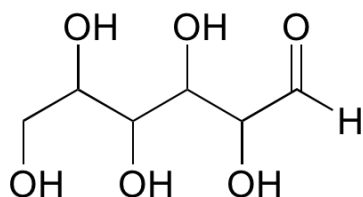

glucose

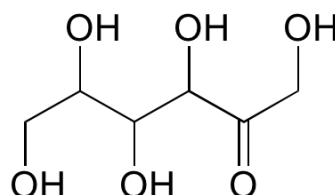

fructose

The hormone testosterone, the amino acid phenylalanine, and the glycolysis metabolite dihydroxyacetone phosphate all contain multiple functional groups, as labeled below.

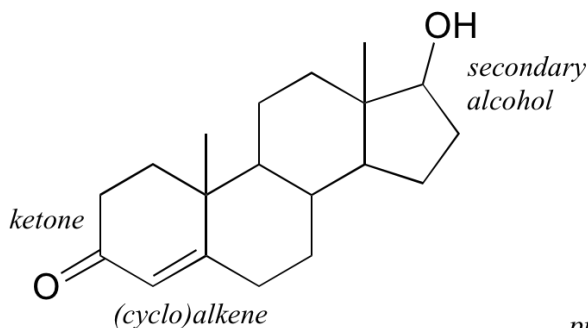

testosterone

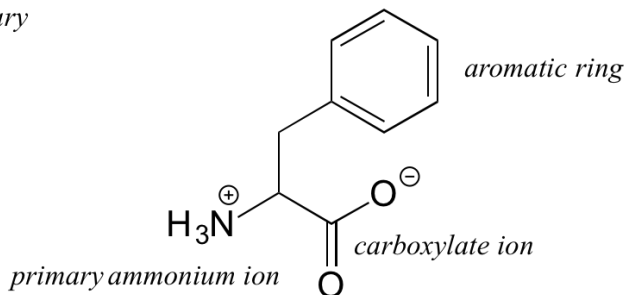

phenylalanine

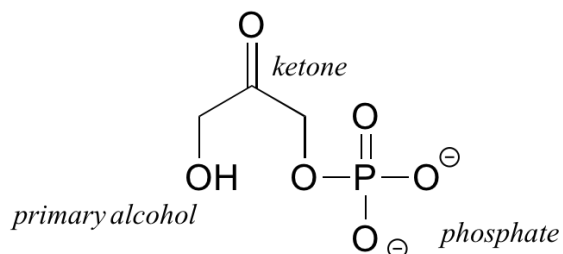

dihydroxyacetone phosphate
(DHAP)

While not in any way a complete list, this section has covered most of the important functional groups that we will encounter in biochemistry. Table 5.7 provides a summary of all of the groups listed in this section.

Table 5.7 Common Organic Functional Groups

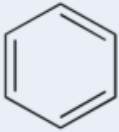
alkane	$\begin{array}{c} \text{H} \quad \text{H} \\ \quad \\ \text{H}-\text{C}-\text{C}-\text{H} \\ \quad \\ \text{H} \quad \text{H} \end{array}$	ketone	$\begin{array}{c} \text{O} \\ \\ \text{H}_3\text{C}-\text{C}-\text{CH}_3 \end{array}$
alkene	$\begin{array}{c} \text{H} \quad \quad \text{H} \\ \diagdown \quad / \\ \text{C}=\text{C} \\ / \quad \diagdown \\ \text{H} \quad \quad \text{H} \end{array}$	aldehyde	$\begin{array}{c} \text{O} \\ \\ \text{H}_3\text{C}-\text{C}-\text{H} \end{array}$
alkyne	$\text{H}-\text{C}\equiv\text{C}-\text{H}$	carboxylic acid	$\begin{array}{c} \text{O} \\ \\ \text{H}_3\text{C}-\text{C}-\text{OH} \end{array}$
aromatic		ester	$\begin{array}{c} \text{O} \\ \\ \text{H}_3\text{C}-\text{C}-\text{O}-\text{CH}_3 \end{array}$
alkyl halide	$\begin{array}{c} \text{H} \\ \\ \text{H}-\text{C}-\text{Cl} \\ \\ \text{H} \end{array}$	amide	$\begin{array}{c} \text{O} \\ \\ \text{H}_3\text{C}-\text{C}-\text{N}-\text{CH}_3 \\ \\ \text{H} \end{array}$

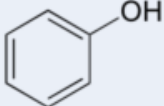
alcohol	$\begin{array}{c} \text{H} \\ \\ \text{H}_3\text{C}-\text{C}-\text{OH} \\ \\ \text{H} \end{array}$	thioester	$\begin{array}{c} \text{O} \\ \\ \text{H}_3\text{C}-\text{C}-\text{S}-\text{CH}_3 \end{array}$
thiol	$\begin{array}{c} \text{H} \\ \\ \text{H}_3\text{C}-\text{C}-\text{SH} \\ \\ \text{H} \end{array}$	acyl phosphate	$\begin{array}{c} \text{O} \\ \\ \text{H}_3\text{C}-\text{C}-\text{O}-\text{P}(\text{O})_2\text{O}^- \end{array}$
amine	$\begin{array}{c} \text{H} \\ \\ \text{H}_3\text{C}-\text{C}-\text{NH}_2 \\ \\ \text{H} \end{array}$	acid chloride	$\begin{array}{c} \text{O} \\ \\ \text{H}_3\text{C}-\text{C}-\text{Cl} \end{array}$
ether	$\text{H}_3\text{C}-\text{O}-\text{CH}_3$	phosphate monoester	$\begin{array}{c} \text{O} \\ \\ \ominus\text{O}-\text{P}-\text{OCH}_3 \\ \\ \text{O}^- \end{array}$
thioether	$\text{H}_3\text{C}-\text{S}-\text{CH}_3$	phosphate <u>diester</u>	$\begin{array}{c} \text{O} \\ \\ \ominus\text{O}-\text{P}-\text{OCH}_3 \\ \\ \text{OCH}_3 \end{array}$
phenol		nitrile	$\text{~}\text{C}\equiv\text{N}$

Exercise 5.10.1

Identify the functional groups (other than alkanes) in the following organic compounds. State whether alcohols and amines are primary, secondary, or tertiary.

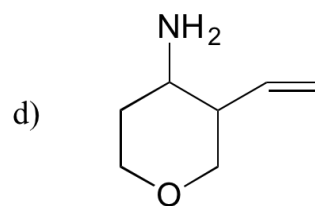
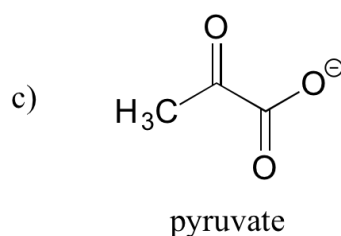
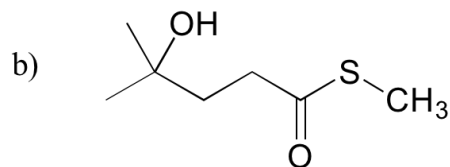
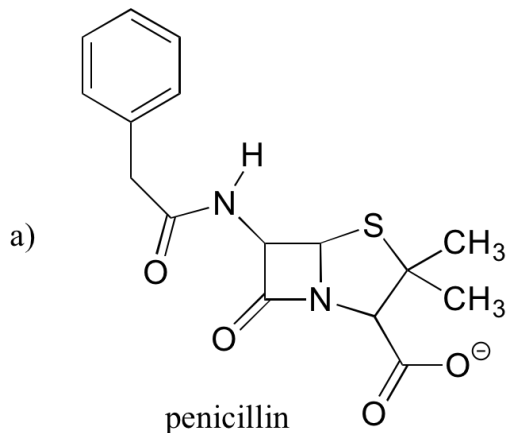

Exercise 5.10.2

Draw one example each of compounds fitting the descriptions below, using line structures. Be sure to designate the location of all non-zero formal charges. All atoms should have complete octets (phosphorus may exceed the octet rule). There are many possible correct answers for these, so be sure to check your structures with your instructor or tutor.

a) a compound with molecular formula $C_6H_{11}NO$ that includes alkene, secondary amine, and primary alcohol functional groups

b) an ion with molecular formula $C_3H_5O_6P^{2-}$ that includes aldehyde, secondary alcohol, and phosphate functional groups.

c) A compound with molecular formula C_6H_9NO that has an amide functional group, and does **not** have an alkene group.

Section 5.11: Chapter Summary

Atoms can share pairs of valence electrons to obtain a valence shell octet. This sharing of electrons is a **covalent bond**. A species formed from covalently bonded atoms is a **molecule** and is represented by a **molecular formula**, which gives the number of atoms of each type in the molecule. The two electrons shared in a covalent bond are called a **bonding pair of electrons**. The electrons that do not participate in covalent bonds are called **nonbonding pairs** (or **lone pairs**) of electrons. A covalent bond consisting of one pair of shared electrons is called a **single bond**.

Covalent bonds occur between nonmetal atoms. Naming simple covalent compounds follows simple rules similar to those for ionic compounds. However, for covalent compounds, numerical prefixes are used as necessary to specify the number of atoms of each element in the compound.

In some cases, more than one pair of electrons is shared to satisfy the octet rule. Two pairs of electrons are shared by two atoms to make a **double bond**. Three pairs of atoms are shared to make a **triple bond**. Single, double, and triple covalent bonds may be represented by one, two, or three dashes, respectively, between the symbols of the atoms. In the case of a **coordinate covalent bond**, one atom supplies both of the electrons and the other atom does not supply any of the electrons.

To judge the relative polarity of a covalent bond, chemists use **electronegativity**, which is a relative measure of how strongly an atom attracts electrons when it forms a covalent bond. The greater the electronegativity difference between the atoms involved in the covalent bond, the more polarity the bond displays.

In comparison to ionic compounds, covalent molecules tend to have lower melting and boiling points, are less soluble in water, and are poor conductors of electricity. These major differences are largely due to increased polarity of ionic bonds when compared with covalent bonds.

Organic molecules can be represented in a number of different ways. You should be able to recognize and draw out organic structures in each of these different structural representations: **molecular formula, a displayed formula, a partially-condensed and fully-condensed structure, and line structures** (with wedges and dashes when appropriate). In addition, regions of an organic structure may be represented by an **R-group**, to save time in structure recreation. This is especially useful when drawing a group of related compounds that only differ in one or two regions. The differing regions of the

molecule can be written out as R-groups to avoid having to redraw the entire molecule each time.

Organic molecules can have isomer structures. **Structural or constitutional isomers** share the same molecular formula but the atoms within the structure are bonded together in a different orientation. **Stereoisomers** have the same molecular formula and the atoms are also bonded together in the same order, however, the 3-dimensional arrangement of the atoms in space is different. A special type of stereoisomer is called an enantiomer. **Enantiomers** are stereoisomers that are mirror images of each other, but are not superimposable. Enantiomers have most of the same physical and chemical properties, however, since biological interactions depend on the 3-dimensional structure of molecules, enantiomers often have different biological activities. Molecules that are mirror images, but are not superimposable are said to have the property of **chirality** or handedness. Carbon displays chirality when it has four different substituents on it.

Functional groups are structural units within organic compounds that are defined by specific bonding arrangements between specific atoms. Just as elements have distinctive properties, functional groups have characteristic chemistries. An -OH functional group on one molecule will tend to react similarly, although not identically, to an -OH group on another molecule. Functional groups are the key structural elements that define how organic molecules react, thus it is important to learn how to recognize common organic functional groups.

Section 5.12: References

Chapter 5 materials have been adapted from the following creative commons resources unless otherwise noted:

1. Organic Chemistry Portal. WikiUniversity. Available at: https://en.wikiversity.org/wiki/Portal:Organic_chemistry
2. Anonymous. (2012) Introduction to Chemistry: General, Organic, and Biological (V1.0). Published under Creative Commons by-nc-sa 3.0. Available at: <http://2012books.lardbucket.org/books/introduction-to-chemistry-general-organic-and-biological/index.html>
3. Poulsen, T. (2010) Introduction to Chemistry. Published under Creative Commons by-nc-sa 3.0. Available at: <http://openedgroup.org/books/Chemistry.pdf>

4. Molecules and Molecular Compounds. (2017) Libretexts. Available at:
[https://chem.libretexts.org/Textbook Maps/General Chemistry Textbook Maps/Map%3A A Chemistry%3A The Central Science \(Brown et al.\)/02. Atoms, Molecules, and Ions/2.6%3A Molecules and Molecular Compounds](https://chem.libretexts.org/Textbook%20Maps/General%20Chemistry%20Textbook%20Maps/Map%3A%20A%20Chemistry%3A%20The%20Central%20Science%20(Brown%20et%20al.)/02.%20Atoms,%20Molecules,%20and%20Ions/2.6%3A%20Molecules%20and%20Molecular%20Compounds)
5. Clark, J. (2017) 'General Principles of Chemical Bonding' Published by Libretexts. Available at:
[https://chem.libretexts.org/Core/Physical and Theoretical Chemistry/Chemical Bonding /General Principles of Chemical Bonding/Coordinate \(Dative Covalent\) Bonding](https://chem.libretexts.org/Core/Physical%20and%20Theoretical%20Chemistry/Chemical%20Bonding/General%20Principles%20of%20Chemical%20Bonding/Coordinate%20(Dative%20Covalent)%20Bonding)
6. OpenStax (2015) Atoms, Isotopes, Ions, and Molecules: The Building Blocks. OpenStax CNX. Available at: <http://cnx.org/contents/be8818d0-2dba-4bf3-859a-737c25fb2c99@12>.
7. Wikipedia, Ionic Compound. Available at:
https://en.wikipedia.org/wiki/Ionic_compound
8. Physical and Theoretical Chemistry (2017) Libretexts. Available at:
[https://chem.libretexts.org/Core/Physical and Theoretical Chemistry/Chemical Bonding /General Principles of Chemical Bonding/Covalent Bonds vs Ionic Bonds](https://chem.libretexts.org/Core/Physical%20and%20Theoretical%20Chemistry/Chemical%20Bonding/General%20Principles%20of%20Chemical%20Bonding/Covalent%20Bonds%20vs%20Ionic%20Bonds).
9. Wikibooks. (2015) Organic Chemistry. Available at:
https://en.wikibooks.org/wiki/Organic_Chemistry.
10. Clark, J. (2014) How to Draw Organic Molecules. Available at: [http://chem.libretexts.org/Core/Organic Chemistry/Fundamentals/How to Draw Organic Molecules](http://chem.libretexts.org/Core/Organic%20Chemistry/Fundamentals/How%20to%20Draw%20Organic%20Molecules)
11. Soderberg, T. (2016). [Organic Chemistry With a Biological Emphasis](#) . Published under Creative Commons by-nc-sa 3.0.
12. Anonymous. (2012) Introduction to Chemistry: General, Organic, and Biological (V1.0). Published under Creative Commons by-nc-sa 3.0. Available at:
<http://2012books.lardbucket.org/books/introduction-to-chemistry-general-organic-and-biological/index.html>
13. Organic Chemistry Portal. WikiUniversity. Available at: https://en.wikiversity.org/wiki/Portal:Organic_chemistry
14. Anonymous. (2012) Introduction to Chemistry: General, Organic, and Biological (V1.0). Published under Creative Commons by-nc-sa 3.0. Available at:

<http://2012books.lardbucket.org/books/introduction-to-chemistry-general-organic-and-biological/index.html>

15. Poulsen, T. (2010) Introduction to Chemistry. Published under Creative Commons by-nc-sa 3.0. Available at: <http://openedgroup.org/books/Chemistry.pdf>

16. OpenStax (2015) Atoms, Isotopes, Ions, and Molecules: The Building Blocks. OpenStax CNX. Available at: <http://cnx.org/contents/be8818d0-2dba-4bf3-859a-737c25fb2c99@12>.

17. Wikipedia, Ionic Compound. Available at: https://en.wikipedia.org/wiki/Ionic_compound

Chapter 6: Natural Products and Organic Chemistry

Section 6.1: Definition and Uses

What is a natural product chemistry and why should we be interested in studying it? The broadest definition of a **natural product** is anything that is produced by life, and includes biotic materials (e.g. wood, silk), bio-based materials (e.g. bioplastics, cornstarch), bodily fluids (e.g. milk, plant exudates), and other natural materials that were once found in living organisms (e.g. soil, coal). A more restrictive definition of a natural product is any organic compound that is synthesized by a living organism. The science of organic chemistry, in fact, has its origins in the study of natural products, and has given rise to the fields of **synthetic organic chemistry** where scientists create organic molecules in the laboratory, and **semi-synthetic organic chemistry** where scientists modify existing natural products to improve or alter their activities.

Natural products have high structural diversity and unique pharmacological or biological activities due to the natural selection and evolutionary processes that have shaped their utility over hundreds of thousands of years. In fact, the structural diversity of natural products far exceeds the capabilities of synthetic organic chemists within the laboratory. Thus, natural products have been utilized in both traditional and modern medicine for treating diseases. Currently, natural products are often used as starting points for drug discovery followed by synthetic modifications to help reduce side effects and increase bioavailability. In fact, natural products are the inspiration for approximately half of U.S. Food and Drug Administration (FDA) approved drugs. In addition to medicine, natural products and their derivatives are commonly used as food additives in the form of spices and herbs, antibacterial agents, and antioxidants to protect food freshness and longevity. In fact, natural organic products find their way into almost every facet of our lives, from the clothes on our backs, to plastics and rubber products, health and beauty products, and even the energy we use to power our automobiles.

Natural products may be classified according to their biological function, biosynthetic pathway, or their source. They are often divided into two major classes: primary and secondary metabolites. **Primary metabolites** are organic molecules that have an intrinsic function that is essential to the survival of the organism that produces them (i.e. the organism would die without these metabolites). Examples of primary metabolites include the core building block molecules (nucleic acids, amino acids, sugars, and fatty

acids) required to make the major macromolecules (DNA, RNA, proteins, carbohydrates, and lipids) responsible for sustaining life. Many hormones, neurotransmitters, and other chemical messengers are also primary metabolites. **Secondary metabolites** in contrast are organic molecules that typically have an extrinsic function that mainly affects other organisms outside of the producer. Secondary metabolites are not essential to survival but do increase the competitiveness of the organism within its environment.

Natural products, especially within the field of organic chemistry, are often defined as primary and secondary metabolites. A more restrictive definition limiting natural products to secondary metabolites is commonly used within the fields of **medicinal chemistry** and **pharmacognosy**, where the study and use of natural products is in the discovery of new medicinal treatments.

Section 6.2: Primary metabolites

Primary metabolites are components of basic metabolic pathways that are required for life. They are associated with essential cellular functions such as nutrient assimilation, energy production, and growth/development. They have a wide species distribution that span many phyla and frequently more than one kingdom. Primary metabolites include the building blocks required to make the four major macromolecules within the body: carbohydrates, lipids, proteins, and nucleic acids (DNA and RNA).

These are large polymers of the body that are built up from repeating smaller monomer units (Fig. 6.1). The monomer units for building the nucleic acids, DNA and RNA, are the nucleotide bases, whereas the monomers for proteins are amino acids, for carbohydrates are sugar residues, and for lipids are fatty acids or acetyl groups.

Primary metabolites that are involved with energy production include numerous enzymes that breakdown food molecules, such as carbohydrates and lipids, and capture the energy released in molecules of adenosine triphosphate (ATP). **Enzymes** are biological catalysts that speed up the rate of chemical reactions. Typically they are proteins, which are composed of amino acid building blocks. The basic structure of cells and of organisms are also composed of primary metabolites. These include cell membranes (e.g. phospholipids), cell walls (e.g. peptidoglycan, chitin), and cytoskeletons (proteins). DNA and RNA which store and transmit genetic information are composed of nucleic acid primary metabolites. Primary metabolites also include molecules involved in cellular signaling, communication and transport. The next few sections will discuss the four major macromolecules in greater detail.

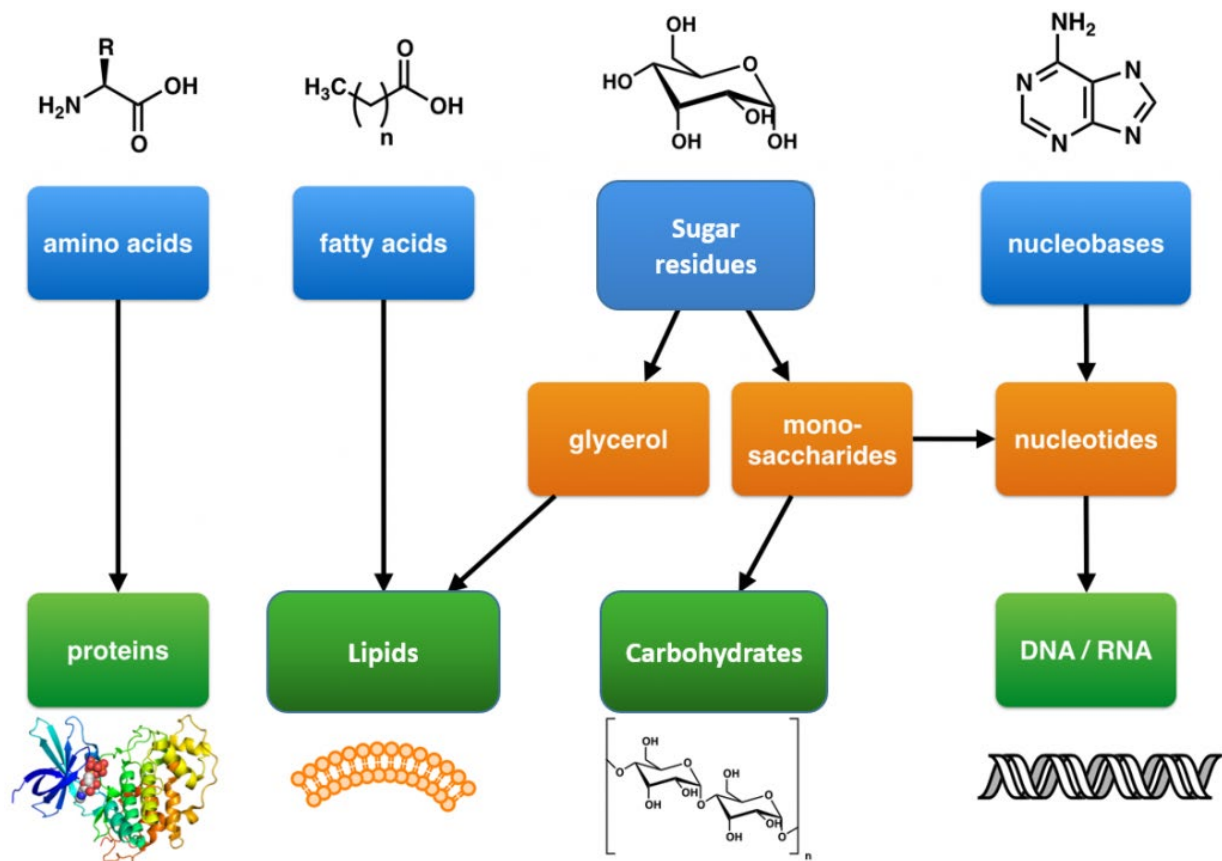

Figure 6.1: The Molecular building blocks of life are made from organic compounds.

Modified from: [Boghog](#)

Section 6.3: Lipids

Lipids are a diverse group of compounds that are united by a common feature. Lipids are hydrophobic (“water-fearing”), or insoluble in water. Lipids perform many different functions in a cell. Cells store energy for long-term use in the form of lipids called triacylglycerides. Lipids also provide insulation from the environment for plants and animals. For example, they help keep aquatic birds and mammals dry because of their water-repelling nature. Lipids are also the building blocks of many hormones and are an important constituent of the plasma membrane. Lipids include fats, oils, waxes, phospholipids, and steroids.



Figure 6.2 The Importance of Lipids in Nature. Water birds, such as ***Larus argentatus*** shown here, maintain and waterproof their feathers by smoothing with an oily substance produced by the uropygial gland located near the anus.

Photo By Lamiot - Own work, CC BY 2.5,
<https://commons.wikimedia.org/w/index.php?curid=1383465>

Fats and Oils

Fats and oils are primarily composed of triacylglycerides (TAGS). These macromolecules consist of two main components—glycerol and fatty acids. Glycerol is an organic alcohol that contains three carbons, five hydrogens, and three hydroxyl (OH) groups. Fatty acids have a long chain of hydrocarbons to which a carboxylic acid group (a carboxyl-) is attached, hence the name “fatty acid.” The number of carbons in the fatty acid may range from 4 to 36; most common are those containing 12–18 carbons. In a TAG, three fatty acids are attached to the glycerol molecule through the alcohol functional groups. This reaction, termed dehydration synthesis, is accompanied with the release of water and will be covered in more detail in chapter 7.

Glycerol

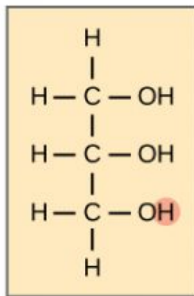

+

Fatty Acid

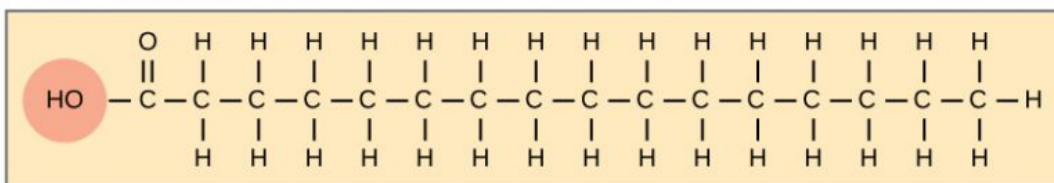

Triacylglycerol

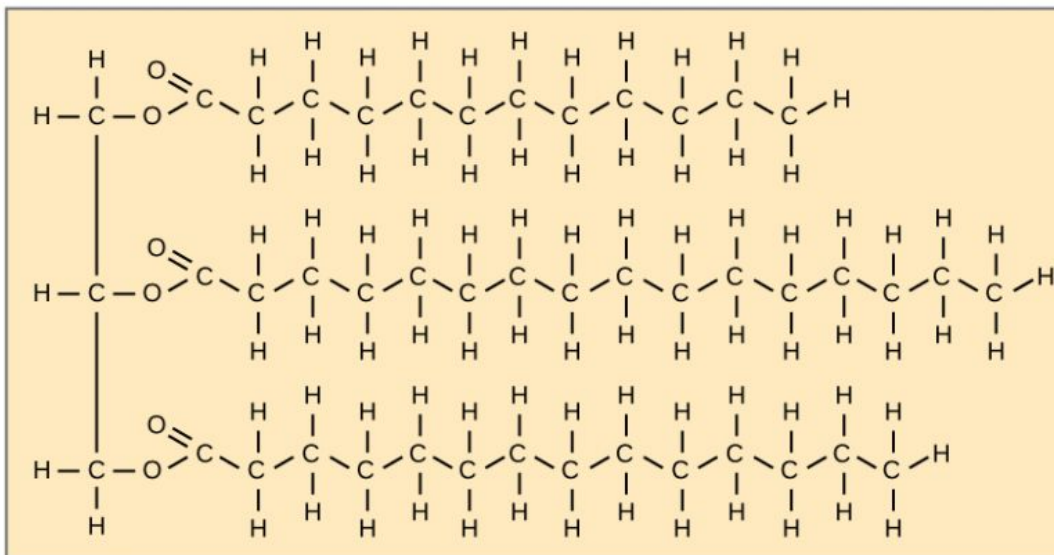

Figure 6.3 Formation of Triacylglycerides (TAGS). Triacylglycerides (TAGS) are formed by the joining of three fatty acids to a glycerol backbone in a dehydration reaction (remember this removes a water molecule and forms a covalent bond). Three molecules of water are released in the process.

The fatty acids that make up TAGS can be either saturated (containing only C-C single bonds) or they can be unsaturated (containing some C-C double bonds). Terms such as saturated fat or unsaturated oil are often used to describe the fats or oils obtained from foods. Saturated fats contain a high proportion of saturated fatty acids and are typically solids at room temperature, while unsaturated oils contain a high proportion of unsaturated fatty acids and are typically liquids at room temperature. This is due to the intermolecular forces present in the different kinds of fats. The most common type of Unsaturated fatty acids found in nature contain double bonds in the **cis** conformation. This causes bends in the fatty acid chain that do not allow the chains to stack upon one another. This keeps them from forming stronger London Dispersion interactions that are seen in the tighter stacking of saturated fatty acids (Figure 6.4). Thus, unsaturated fats in the **cis** conformation tend to have lower melting temperatures than saturated fatty acids and are liquids at room temperature. Unsaturated fats that have **trans** double bonds do not have bends in their chain and can still stack in a similar fashion to saturated fats. Thus, unsaturated **trans** fatty acids tend to be solids at room temperature. **Cis** unsaturated fatty acids are common in nature, while **trans** unsaturated fatty acids are rare. **Trans**-unsaturated fatty acids are typically a by-product of food processing or deep-fat frying. The high consumption of saturated fats or trans-unsaturated fats is a factor, along with the high consumption of cholesterol, in increased risks of heart disease.

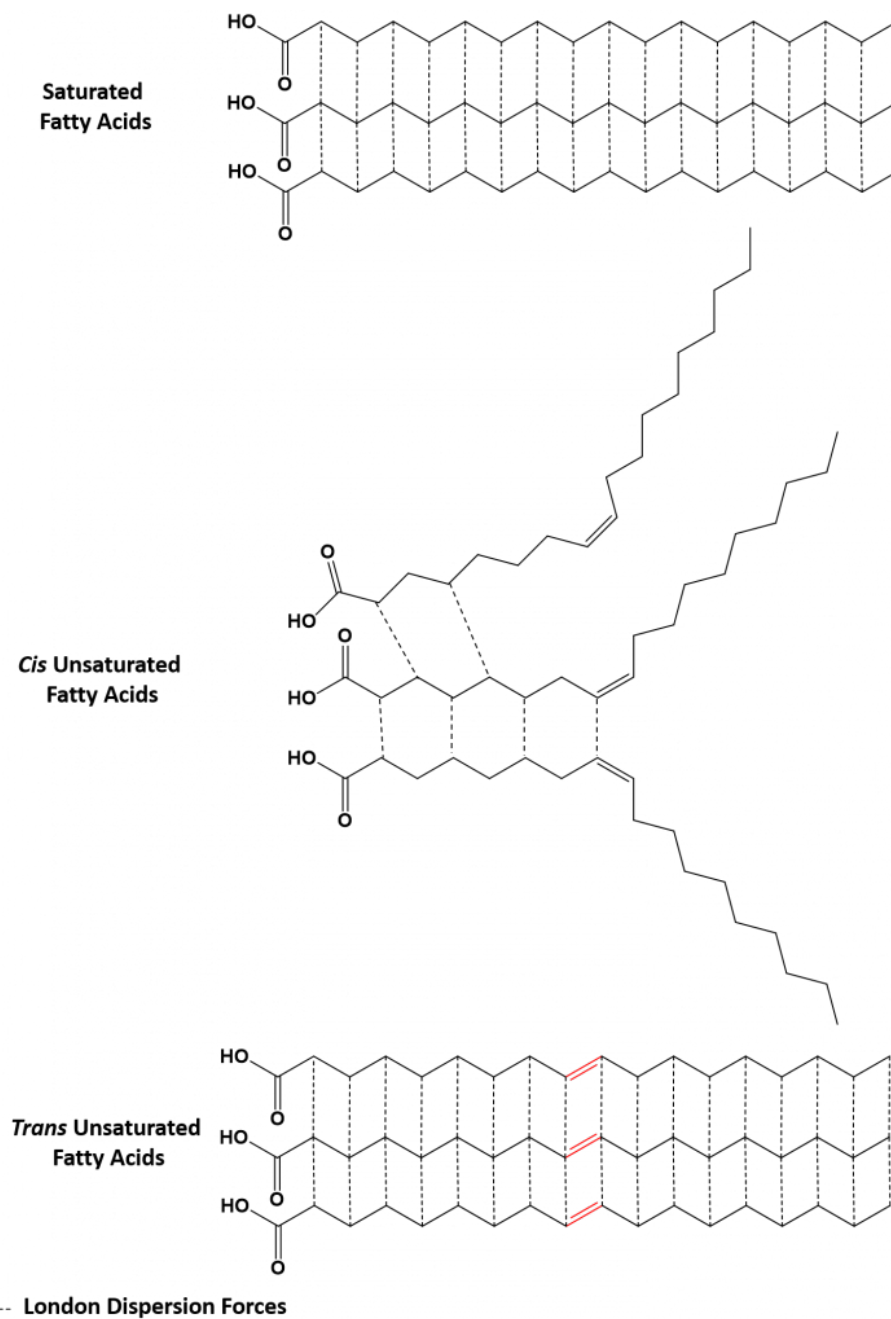

Figure 6.4 Saturated and Unsaturated Fatty Acids. Saturated fatty acids only contain carbon-carbon single bonds and thus, can stack on one another forming many London Dispersion intermolecular interactions (dashed lines). Unsaturated fatty acids in the cis conformation have bends in their chains that prevent them from stacking and forming substantial London Dispersion bonds. Thus, they tend to have lower melting temperatures and are liquids at room temperature. Unsaturated fatty acids in the trans conformation, do not have bends and thus, can stack and form London Dispersion interactions similar to that of saturated fatty acids.

Waxes

Waxes are produced by many different plants and animals. Waxes made by animals are typically esters of fatty acids, as shown in Figure 6.5, whereas those made by plants are commonly mixtures of unesterified hydrocarbons. Plants commonly use waxes on the cuticles of plant leaves where they can repel water. Bees use wax to form their intricate honeycombs, and the sperm whale produces large amounts of waxes and oils called spermaceti. The spermaceti organ is located in the head of the sperm whale, where it can hold large amounts of oil. The sperm whale is capable of heating and lowering the temperature of the spermaceti oils and waxes, helping the whale control its buoyancy in the ocean. Heating the oil lowers its density and allows the whale to float, whereas lowering the temperature increases the density and allows the whale to sink again. In the late 1800's and early 1900's sperm whale oil was considered the finest lubricating oil on Earth, and was used for the lubrication of fine machinery, such as pocket watches.

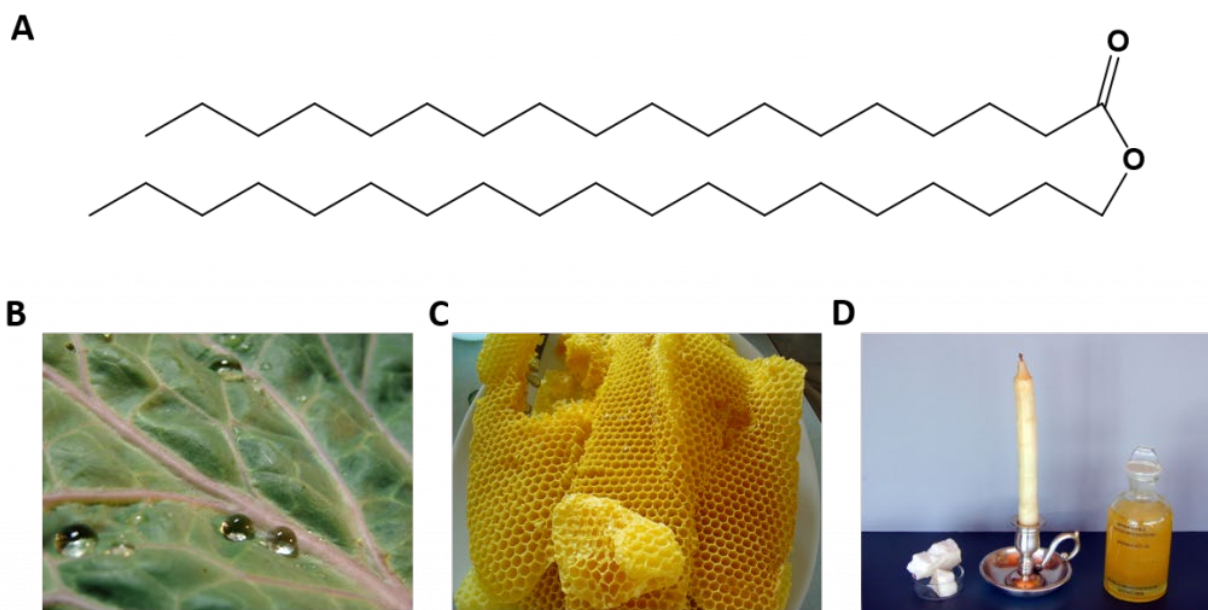

Figure 6.5 Examples of Waxes in Nature. (A) A typical wax ester contains two long chain hydrocarbons joined by an ester linkage. (B) Photo of water beading on the waxy cuticle of a kale leaf. (C) honeycomb made of beeswax, and (D) Spermaceti wax sample, a spermaceti candle, and spermaceti oil from the head of a sperm whale. (B) Courtesy of [Rei](#) at [en.wikipedia](#), (C) Courtesy of [Boutet, E.](#) and (D) Courtesy of [Einzelheiten zur Genehmigung](#)

Phospholipids

Phospholipids are major constituents of the plasma membrane, the outermost layer of animal cells. Like TAGS, they are composed of fatty acid chains covalently bonded to a glycerol or sphingosine backbone. Instead of three fatty acids attached as in TAGS, however, there are two fatty acids forming diacylglycerol, and the third carbon of the glycerol backbone is occupied by a modified phosphate group (Figure 6.6).

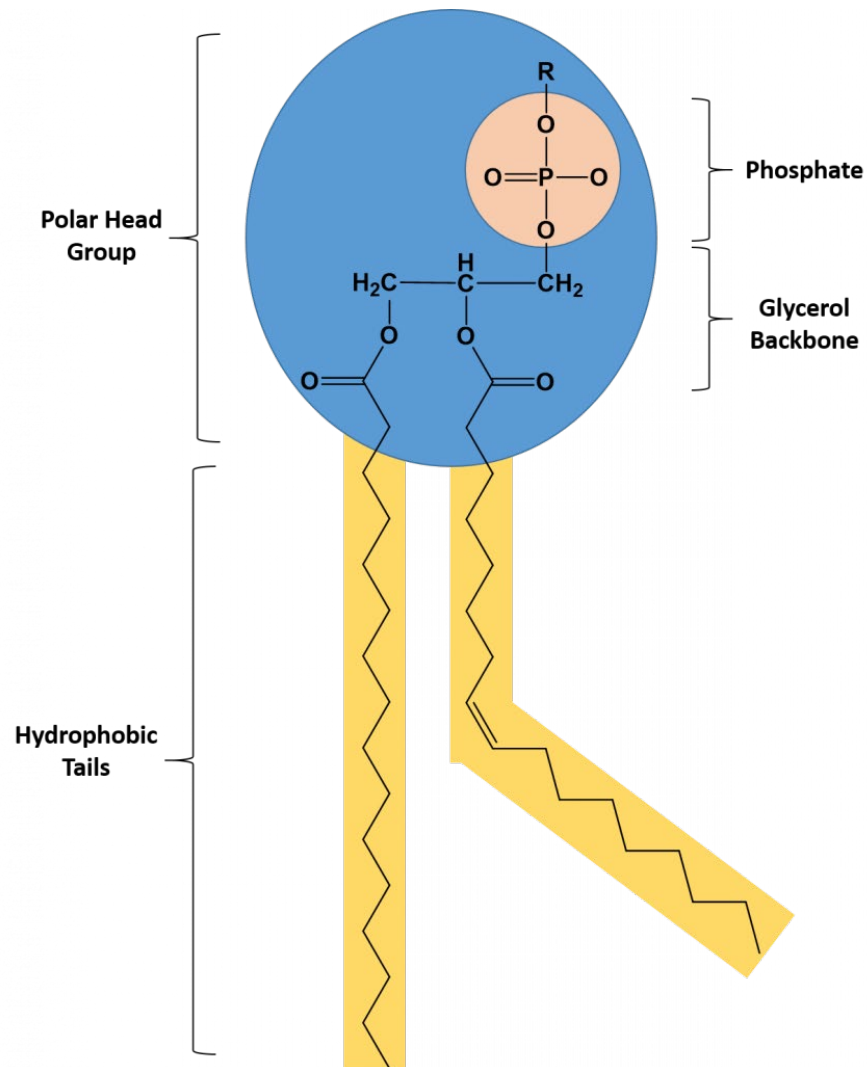

Figure 6.6 The Structure of a Phospholipid. A phospholipid is a molecule with two fatty acids and a modified phosphate group attached to a glycerol backbone. The phosphate may be modified by the addition of charged or polar chemical groups at the position designated with an R.

A phospholipid is an **amphipathic** molecule, meaning it has both a hydrophobic and a hydrophilic part. The fatty acid chains are hydrophobic and cannot interact with water, whereas the phosphate-containing group is hydrophilic and interacts with water (Figure 6.7). The head is the hydrophilic part, and the tail contains the hydrophobic fatty acids. In a membrane, a bilayer of phospholipids forms the matrix of the structure, the fatty acid tails of phospholipids face inside, away from water, whereas the phosphate group faces the outside, aqueous side. This forms a hydrophobic layer on the inside of the bilayer, where the tails are located.

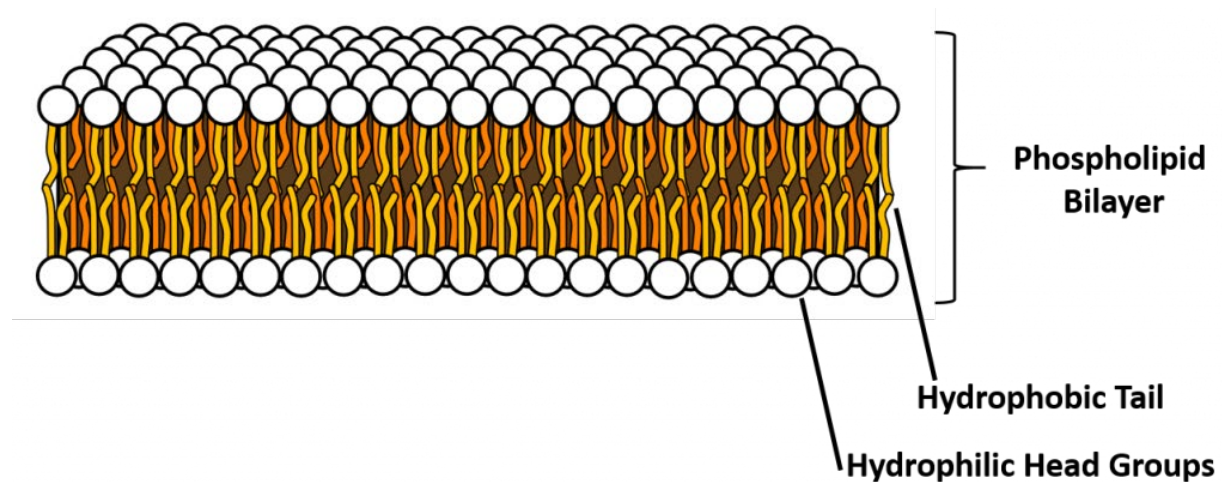

Figure 6.7 The phospholipid bilayer is the major component of all cellular membranes. The hydrophilic head groups of the phospholipids face the aqueous solution. The hydrophobic tails are sequestered in the middle of the bilayer. Credit AmitWo, Wikimedia; <https://commons.wikimedia.org/wiki/File:Micelle.svg>

Phospholipids are responsible for the dynamic nature of the plasma membrane. There are proteins embedded within the plasma membrane that function in the transport of molecules across the membrane or that can receive signals and serve as receptors in cell-to-cell communication (Figure 6.8). Due to the oily nature of the hydrophobic tails, the plasma membrane retains a fluid nature where the embedded proteins can move laterally from one area to another, much like they are swimming in the membrane. This is known as the fluid mosaic model. Note that some proteins extend all the way through the plasma membrane and these are called integral membrane proteins. Others are found only attached to the extracellular side or the intracellular side of the membrane. These proteins are known as peripheral membrane proteins. In addition to proteins, carbohydrates can also be attached to either lipids (glycolipids) or proteins (glycoproteins) within the plasma

membrane. Carbohydrates often serve as recognition signals for cell-to-cell communication.

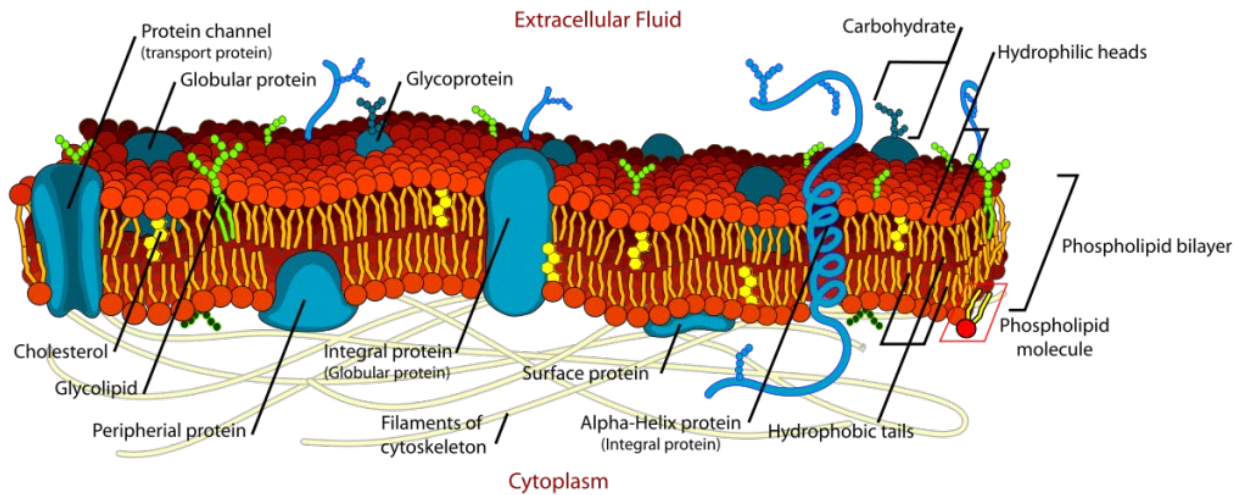
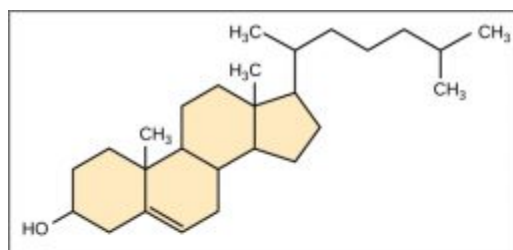

Figure 6.8. The Fluid Mosaic Model of the Plasma Membrane. The plasma membrane core structure is the phospholipid bilayer. Embedded within this core structure are integral and peripheral membrane proteins. The proteins within the plasma membrane can move laterally through the plasma membrane. Carbohydrates are often attached to either lipids or proteins within the plasma membrane where they play a role in cell-to-cell communication.

Steroids

Unlike the phospholipids and TAGS discussed earlier, steroids have a fused ring structure. Although they do not resemble the other lipids, they are grouped with them because they are also hydrophobic and insoluble in water. All steroids have four linked carbon rings and several of them, like cholesterol, have a short tail (Figure 6.9). Many steroids also have the $-OH$ functional group, which puts them in the alcohol classification (sterols). Remember that each line in these diagrams of chemical structures represents a covalent bond. The points where the lines connect to each other show the location of carbon atoms – these carbon atoms are not labeled, but their existence is implied in the chemical structure.



Cholesterol

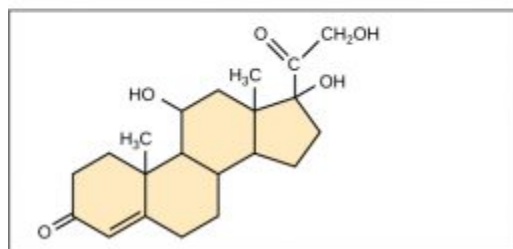

Cortisol

Figure 6.9 Steroids such as cholesterol and cortisol are composed of four fused hydrocarbon rings.

Cholesterol is the most common steroid. Cholesterol is mainly synthesized in the liver and is the precursor to many steroid hormones such as testosterone and estradiol, as well as to Vitamin D. Cholesterol is also the precursor for bile salts, which help in the emulsification of fats during the digestion process. and their subsequent absorption by cells. Although cholesterol is often spoken of in negative terms by lay people, it is necessary for proper functioning of the body. It is a component of the plasma membrane of animal cells and is found within the phospholipid bilayer where it regulates the rigidity of the plasma membrane. At high temperatures, cholesterol helps to stabilize the membrane and raise the melting temperature. At low temperatures, cholesterol keeps the hydrophobic tails from clustering together and stiffening too much.

Overall, lipids make up important cellular structures, such as the plasma membrane, are critical in cell-to-cell communication where they often serve as hormones or localized signaling molecules. **Hormones** are any molecule that is produced in one area of the body, is secreted into the blood stream where it travels to a distant location to mediate its effect. Testosterone and estradiol are good examples of steroid hormones. Lipids, such as TAGS, are also essential for providing energy for the body. Chapter 8 will look more closely at the regulation TAG and carbohydrate energy sources.

Section 6.4: Carbohydrates

Carbohydrates are macromolecules with which most consumers are somewhat familiar. To lose weight, some individuals adhere to “low-carb” diets. Athletes, in contrast, often “carb-load” before important competitions to ensure that they have sufficient energy to compete at a high level. Carbohydrates are, in fact, an essential part of our diet; grains, fruits, and vegetables are all natural sources of carbohydrates. Carbohydrates provide energy to the body, particularly through glucose, a simple sugar. Carbohydrates also have other important functions in humans, animals, and plants, including cell recognition, structural support, and by providing cushioning support in the extracellular matrix of joints.

Carbohydrates can be represented by the stoichiometric formula $(CH_2O)_n$, where n is the number of carbons in the molecule. In other words, the ratio of carbon to hydrogen to oxygen is 1:2:1 in carbohydrate molecules. This formula also explains the origin of the term “carbohydrate”: the components are carbon (“carbo”) and water (hence, “hydrate”). Thus, compared with lipids, carbohydrates are much more polar and many are soluble in water. Carbohydrates are classified into three subtypes: monosaccharides, disaccharides, and polysaccharides.

Monosaccharides

Monosaccharides (mono- = “one”; sacchar- = “sweet”) are simple sugars, the most common of which is glucose. In monosaccharides, the number of carbons usually ranges from three to seven. Most monosaccharide names end with the suffix -ose.

The chemical formula for glucose is $C_6H_{12}O_6$. In humans, glucose is an important source of energy. During cellular respiration, energy is released from glucose, and that energy is used to help make adenosine triphosphate (ATP). Plants synthesize glucose using carbon dioxide and water, and glucose in turn is used for energy requirements for the plant. Excess glucose is often stored as starch that is catabolized (the breakdown of larger molecules by cells) by humans and other animals that feed on plants.



Figure 6.10 Bread, pasta, and sugar all contain high levels of carbohydrates. (“Wheat products” by US Department of Agriculture is in the Public Domain)

Galactose (part of lactose, or milk sugar) and fructose (found in sucrose, in fruit) are other common monosaccharides and also share the same molecular formula as glucose, $C_6H_{12}O_6$. Although glucose, galactose, and fructose all have the same chemical formula ($C_6H_{12}O_6$), they differ structurally and chemically (and are known as isomers) because of the different arrangement of functional groups around the asymmetric carbon; all of these monosaccharides have more than one asymmetric carbon. The glucose-fructose pair and galactose-fructose pair are structural isomers as the bonding order of their atoms differ. Glucose and galactose on the other hand are stereoisomers, as they have the same bonding order, but a different 3-dimensional arrangement in space. In addition, you can see that glucose and galactose each have an aldehyde functional group, whereas fructose has a ketone functional group. Sugars that contain aldehyde functional groups are called aldoses, whereas sugars that have ketone functional groups are called ketoses.

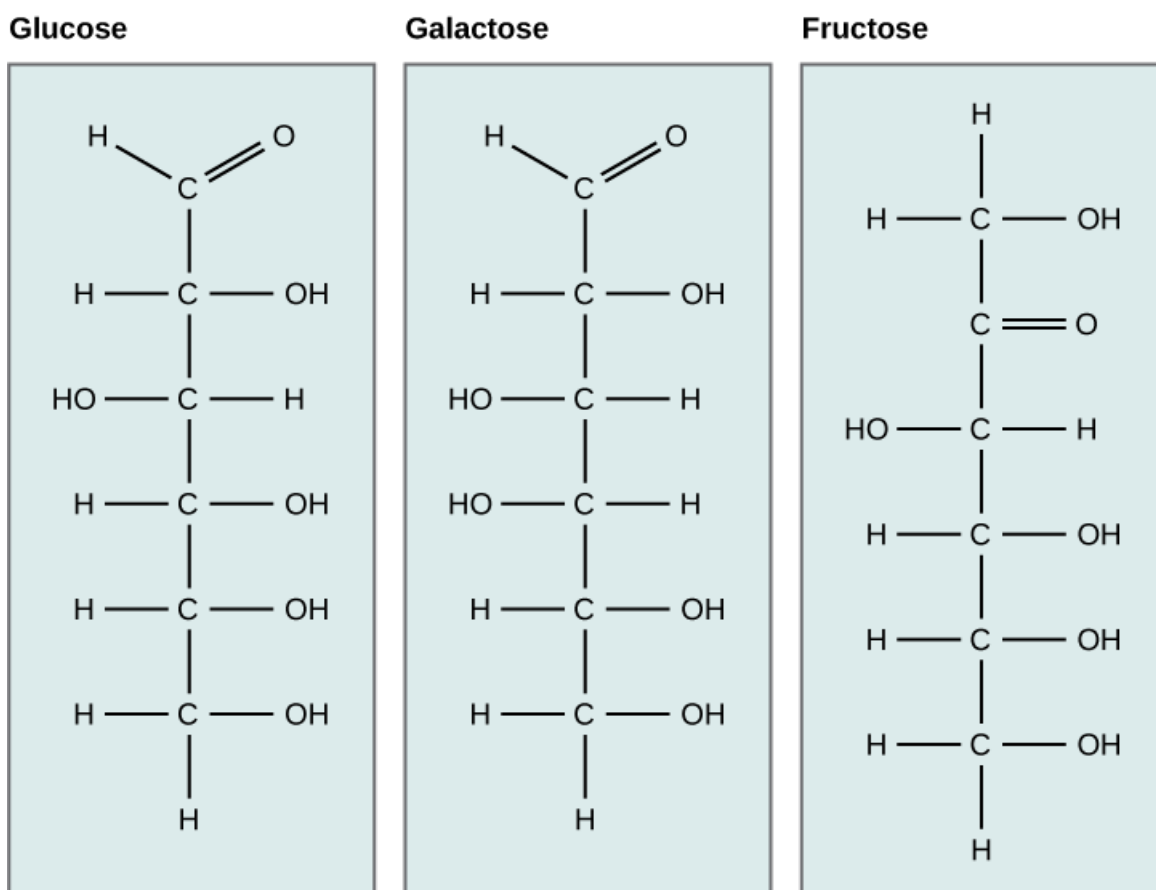

Figure 6.11 Glucose, galactose, and fructose are all hexoses. They are structural isomers, meaning they have the same chemical formula ($C_6H_{12}O_6$) but a different arrangement of atoms. Fructose is a ketose sugar, whereas glucose and galactose are aldoses.

Sugars are structurally quite complex because they contain a high number of chiral centers. For example, if you look at glucose in Figure 6.11, you will see that only the first and the last carbons in the chain are achiral. The first carbon is bonded in the aldehyde functional group and therefore contains two bonds to the same oxygen. Thus, it cannot be chiral. Similarly, the 6th carbon is bonded to two hydrogen atoms and also lacks chirality. The remaining four carbons are each bonded to four different substituents and therefore have chirality.

Due to the high amount of chirality, sugars often have many isomer possibilities. For example, the number of stereoisomers possible for glucose is 2^n , where n = the number of chiral centers. For glucose, $n = 4$. Thus, there are a total of $2 \times 2 \times 2 \times 2 = 16$ possible stereoisomers! Note that we are only listing the stereoisomers, not the vast number of structural isomers that are also possible. Recall that for protein recognition, the shape of the molecule in 3-dimensional space is critical. Thus, since carbohydrates have such a high possibility of isomeric forms, they are ideal components for cell-to-cell recognition, as small changes in the carbohydrate structure can be used for vastly different messages to the surrounding cells.

Note that for every sugar, there will be one other sugar that is exactly opposite at all of the chiral centers of the molecule. This exact opposite is the mirror image of the other sugar, but is not superimposable. This exact opposite is called the enantiomer. Note that enantiomer pairs have all of the same physical properties, except for the direction that they can rotate plain polarized light. Thus, they are very hard to tell apart and to separate from one another. They are in fact, given the same name, with the prefix of D- or L- to designate which way that they rotate plain polarized light. D- is given for sugars that rotate light in the right-handed or dextrorotatory, and L- is given for sugars that rotate light in the left-handed or levorotatory direction.

D-sugars are the ones predominantly produced in nature. To distinguish the D- and the L- conformations from one another, look at the chiral center that is farthest from the ketone or aldehyde functional group. If the hydroxyl (-OH) functional group is on the right hand side, it is the D- conformation, if the hydroxyl (-OH) functional group is on the left hand side, it is the L- conformation. The two enantiomers of glucose and fructose are shown below in Figure 6.12 as examples.

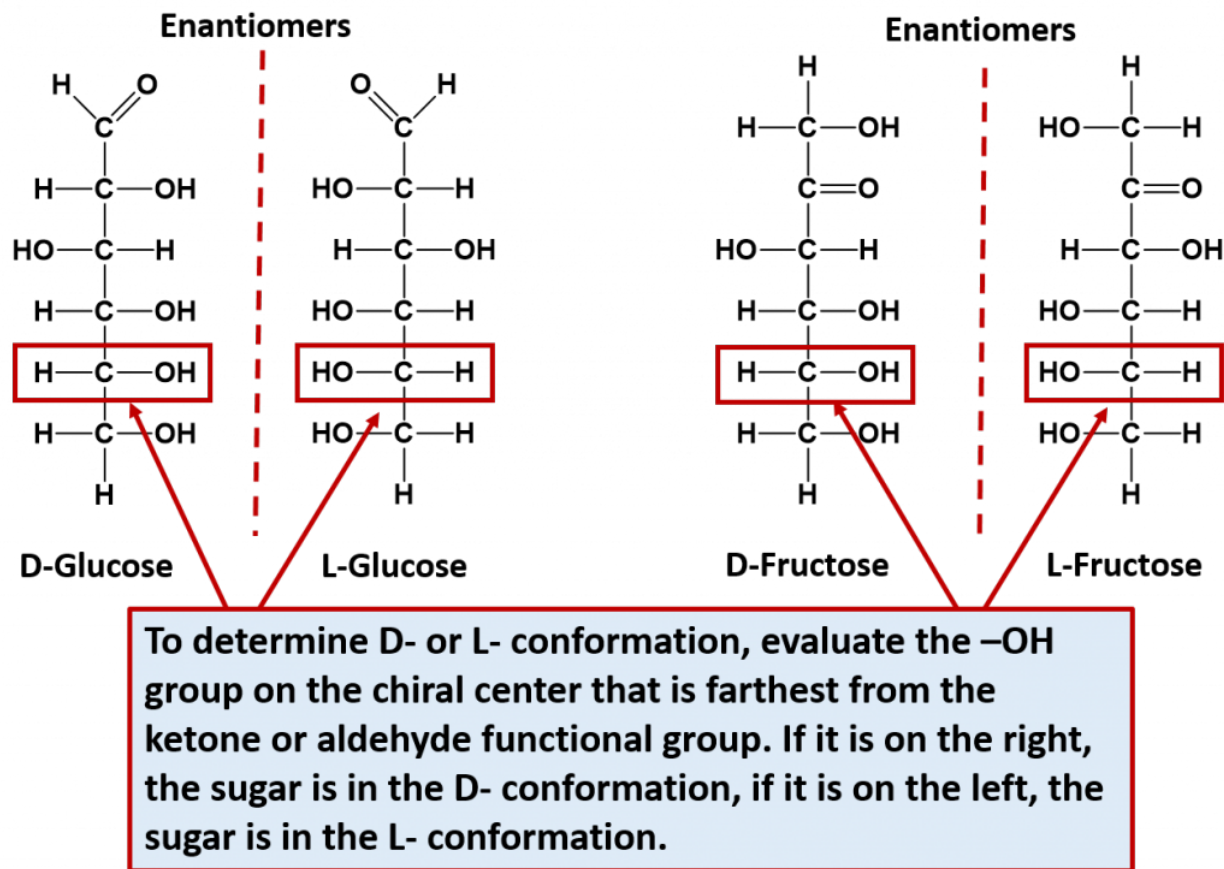

Figure 6.12 Enantiomer Pairs. Enantiomers are stereoisomers that are mirror images of one another but are not superimposable. For monosaccharides, each sugar can exist in the D- or L-conformation depending on which direction they rotate plain polarized light. To determine the D- or L- conformation, evaluate the -OH located on the chiral center farthest away from the ketone or aldehyde functional group. If it is on the right hand side, the sugar is the D- conformation. If it is on the left hand side, it is the L- conformation.

Monosaccharides that have 5 or 6 carbons, will often spontaneously cyclize to form 5- or 6-membered ring structures. When they do this, the carbon of the aldehyde or ketone functional group will accept the incoming bond causing the carbonyl bonded oxygen to become another hydroxyl functional group on the sugar. This introduces one additional chiral center into the molecule and forms another unique pair of isomers that are called anomers. The new anomers are called the alpha (α) and beta (β) conformations. Figure 6.13 demonstrates how glucose cyclizes to form the alpha and beta anomeric forms.

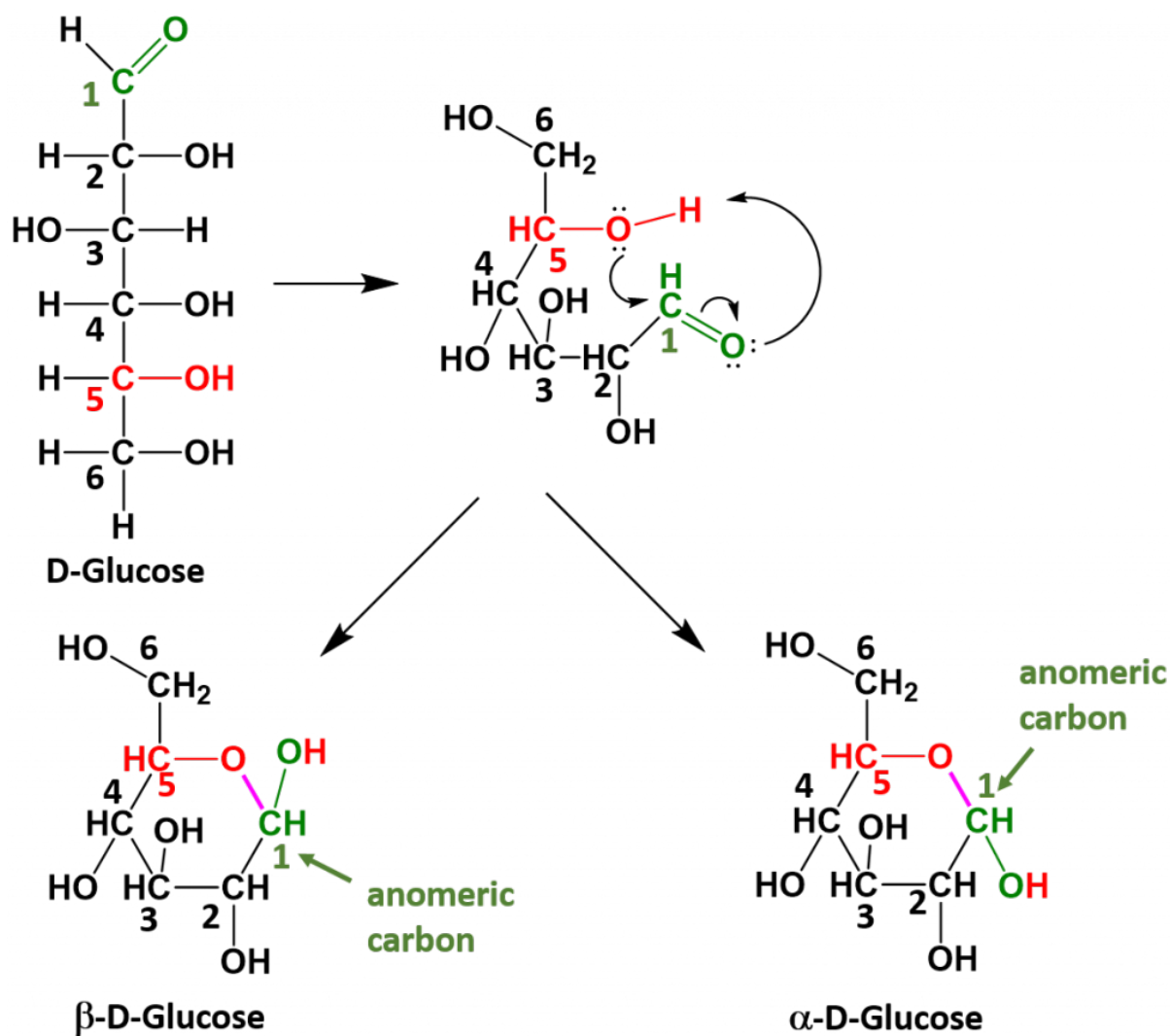

Figure 6.13 Cyclization of Glucose. When glucose cyclizes the oxygen from the 5th carbon, shown in red, attacks the carbonyl carbon at position 1, shown in green. This pushes the double bond up onto the carbonyl oxygen which enables the carbonyl oxygen to take the hydrogen from the hydroxyl group on position 5. This forms a new bond, shown in purple between the oxygen at position 5 and the carbon at position 1. The carbon at position 1 is then bonded to two oxygen molecules and is known as the anomeric carbon, shown in green.

Once the linear sugar has cyclized, this forms a new functional group called a hemiacetal (which is essentially a hydroxyl group next to an ether functional group with the anomeric carbon sandwiched in between. This functional group is represented by the red and

green colored atoms present in Figure 6.13. The formation of the hemiacetal is important because this is the reactive functional group that allows for the formation of disaccharides and polysaccharides. This dehydration reaction is covered in more detail in chapter 7.

Disaccharides

Disaccharides (di- = "two") form when two monosaccharides undergo a dehydration reaction (also known as a condensation reaction or dehydration synthesis). This reaction will be covered in more detail in Chapter 7. During this process, the hydroxyl (OH) group of the hemiacetal from one monosaccharide combines with the hydrogen from a hydroxyl group of another monosaccharide, releasing a molecule of water and forming a covalent bond which joins the two monosaccharides together through an oxygen linkage. This new bond is called a **glycosidic bond**. Figure 6.14 shows the formation of the disaccharide maltose from two α -D-glucose monomers.

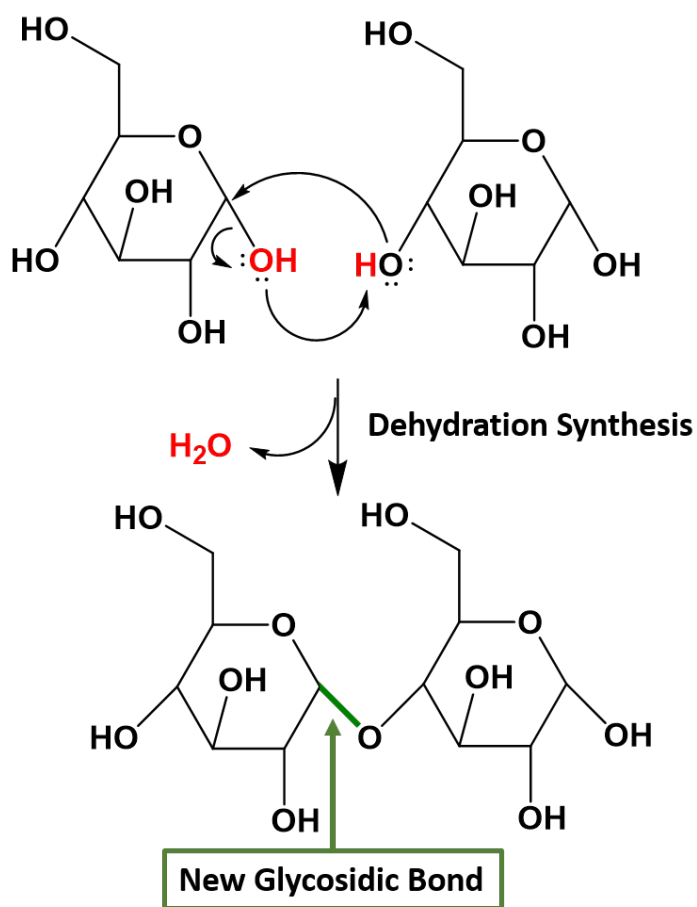

Figure 6.14 Formation of a Glycosidic Bond. In this example, two α -D-glucose monomers combine to form the disaccharide maltose. Glycosidic bonds, shown in green, are formed when two sugars undergo dehydration synthesis joining the sugar molecules through an oxygen linkage. The hydroxyl from the hemiacetal on one sugar, shown in red, combines with a hydrogen from the hydroxyl of another sugar, shown in red, to form the leaving water molecule, shown in red. The remaining oxygen from the hydroxyl group forms the glycosidic bond, shown in green, with the anomeric carbon atom from the first sugar.

Common disaccharides include maltose, lactose, and sucrose (Figure 6.15). Maltose, or malt sugar, is a disaccharide composed of two glucose molecules. It is not commonly produced in nature, but is often a breakdown product when starch is being digested. It is also common in the juice of grains such as barley. Lactose is a disaccharide commonly found in the milk of lactating mammals. Human infants are able to use lactose as a food source because they express the lactase enzyme that is responsible for breaking down the lactose into its monosaccharide units. When growing into adulthood, many people become lactose intolerant because the expression of the lactase enzyme is altered or down regulated. Certain populations of humans originating in Scandinavia and regions in Africa have acquired mutations that have allowed continued expression of the lactase enzyme and enabled the consumption of dairy products into adulthood. The most familiar disaccharide is sucrose, or table sugar, which is composed of the monomers glucose and fructose.

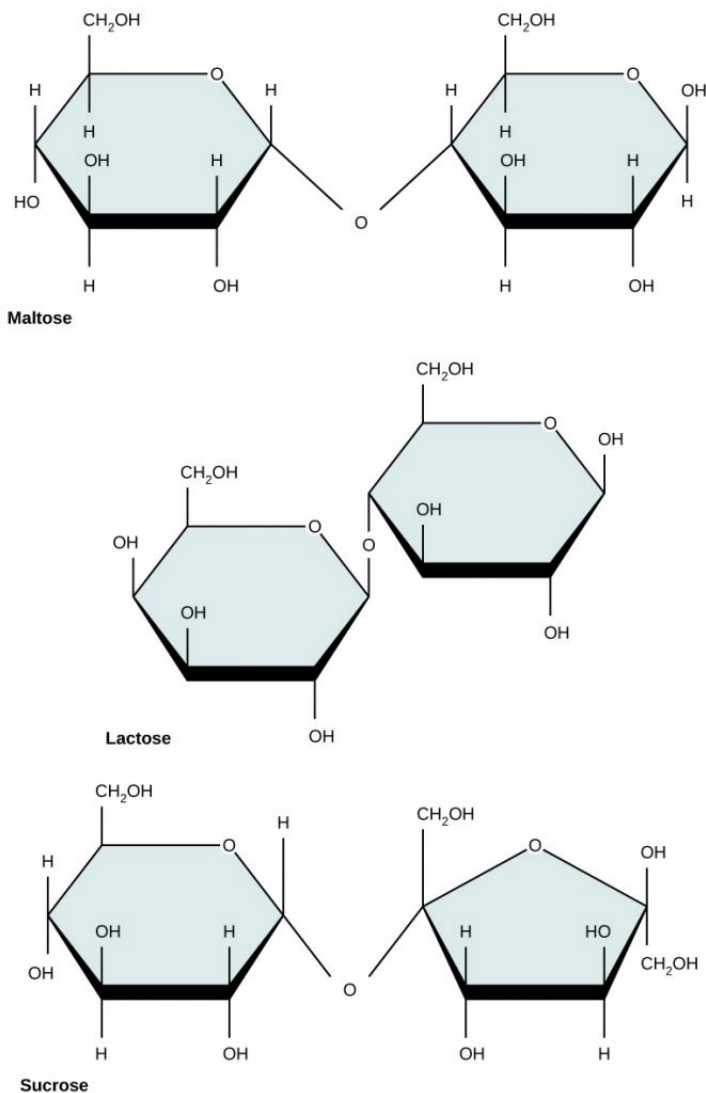

Figure 6.15 Common disaccharides include maltose (grain sugar), lactose (milk sugar), and sucrose (table sugar).

Polysaccharides

A long chain of monosaccharides linked by glycosidic bonds is known as a polysaccharide (poly- = "many"). The chain may be branched or unbranched, and it may contain different types of monosaccharides. All of the monosaccharides are connected together by covalent glycosidic bonds through the process of dehydration synthesis. The molecular weight may be very large, upwards of 100,000 daltons or more depending on the number of monomers joined. Starch, glycogen, cellulose, and chitin are primary examples of polysaccharides.

Starch is the stored form of sugars in plants and is made up of a mixture of amylose and amylopectin (both polymers of glucose). Amylose is a straight chain of glucose linked together at the α 1,4 position (or from the 1-position anomeric carbon on one glucose to the oxygen on the 4 carbon of the next glucose in the chain). Amylopectin is more complex than the amylose, in that it has branching associated with the structure. It has the same α 1,4 glucose main chain as the amylose structure, but it also has α 1,6 branches about every 25 glucose residues (Figure 6.16). Note that all of the glucose monomers present in both starch and glycogen are in the α -D-conformation. Plants are able to synthesize glucose, and the excess glucose, beyond the plant's immediate energy needs, is stored as starch in different plant parts, including roots and seeds. The starch in the seeds provides food for the embryo as it germinates and can also act as a source of food for humans and animals. The starch that is consumed by humans is broken down by enzymes, such as salivary amylases, into smaller molecules, such as maltose and glucose. The cells can then absorb and utilize the glucose for energy.

Glycogen is the storage form of glucose in humans and other vertebrates and is very similar in structure to that of amylopectin. Glycogen, however, has a much higher rate of α 1,6 branching than amylopectin (with branches occurring about every 10 residues). The need for the higher branching, is that glycogen can only be broken down starting from the ends of the molecule to release single glucose monomers. If there was only one end, as in the amylose molecule, it would take a long time to release glucose that could then be used to create energy needed by muscles and other tissues in the body. By having a branching molecule, there are more ends of the molecule that are useful for the quick breakdown and release of glucose. This is needed in animals that may need quick bursts of energy to elude a predator or chase down prey. Within animals, glycogen is predominantly stored in the liver (about 10% of the mass of the liver is glycogen!) and in muscle cells (approximately 2% of the total mass).

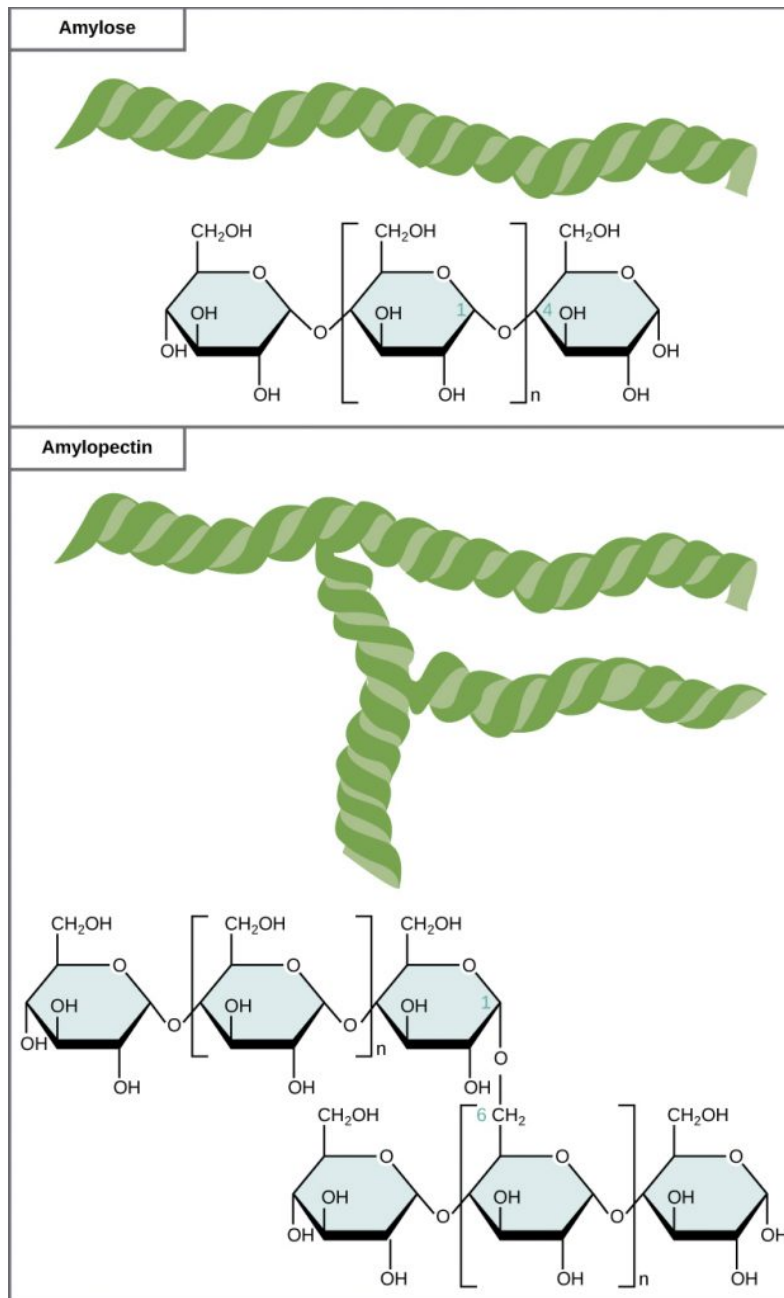

Figure 6.16 Amylose and amylopectin are two different forms of starch. Amylose is composed of unbranched chains of glucose monomers. Amylopectin is composed of branched chains of glucose monomers. Because of the way the subunits are joined, the glucose chains have a helical structure. Glycogen (not shown) is similar in structure to amylopectin but more highly branched.

In addition to being a tasty food, carbohydrate polymers can serve as structural support molecules as well. Cellulose is the most abundant natural carbohydrate and serves as a structural biopolymer. It is made up of β 1,4 linkages between the glucose molecules. This creates a linear structure where each glucose monomer is flipped upside down compared with the last. When the fibers from one cellulose strand are then aligned with another fiber they can form strong hydrogen bond interactions that build strong fiber networks (Figure 6.17). The cell wall of plants is mostly made of cellulose; this provides structural support to the cell. Wood and paper are also mostly cellulosic in nature.

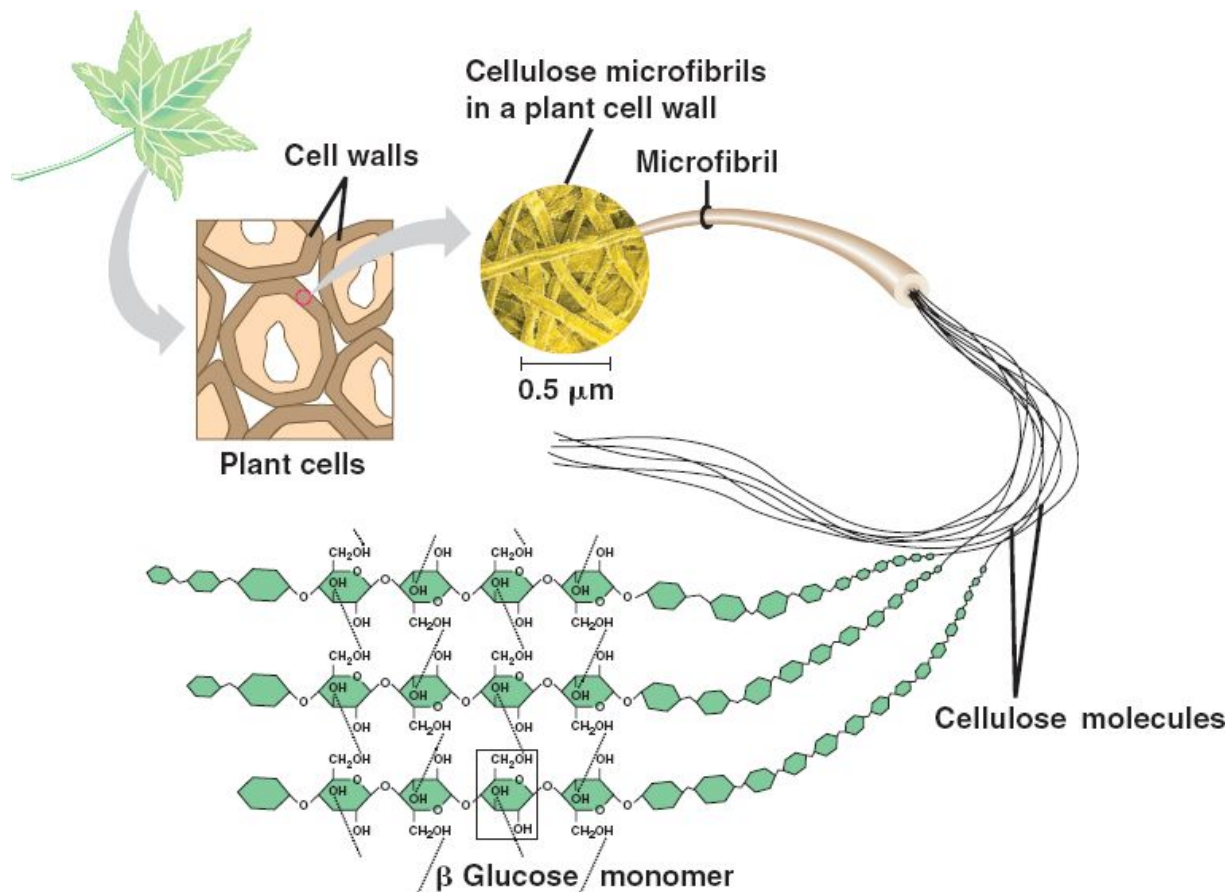

Figure 6.17 In cellulose, glucose monomers are linked in unbranched chains by β 1,4 linkages. Because of the way the glucose subunits are joined, every glucose monomer is flipped relative to the next one resulting in a linear structure that can form hydrogen bonds with neighboring strands. The result of the hydrogen bonded strands produces very strong fibrous material.

Figure provided by [Marta O. under Creative Commons](#)

Interestingly, the exoskeleton of many insects is made from a modified form of cellulose that is called chitin. Chitin is modified with the incorporation of nitrogen into the sugar structure. The repeating structural units are called N-acetyl- β -d-glucosamine and are shown in Figure 6.18. Chitin is also a major component of fungal cell walls; fungi are neither animals nor plants and form a kingdom of their own in the domain Eukarya. Polymers containing N-acetyl- β -d-glucosamine also occur in humans where they are present in extracellular matrix and provide cushioning for joints. In fact, N-acetyl- β -d-glucosamine is one of the most prominent dietary supplements sold in the United States, provided to support joint health.

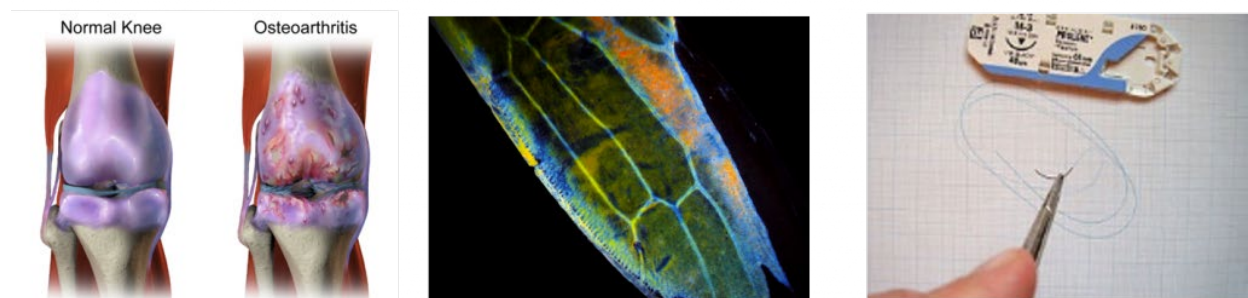
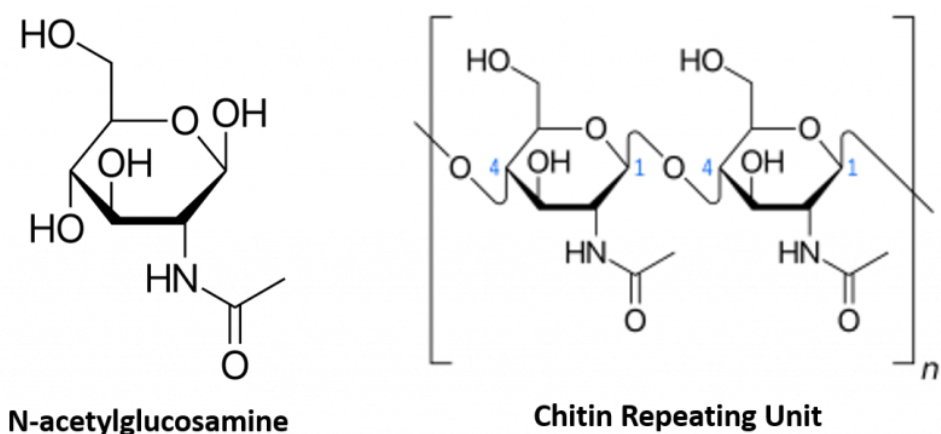

Figure 6.18 N-acetyl- β -d-glucosamine is a common modified sugar in polysaccharides. N-acetyl- β -d-glucosamine (upper left) is the repeating sugar unit in the polymer, chitin (upper right). N-acetyl- β -d-glucosamine is a component of normal joint cushioning (lower left). Chitin is a primary polysaccharide in the hard exoskeleton of insects as shown in the wing of the leafhopper (middle photo). Chitin has been utilized in medical technology to serve as material for surgical sutures. It provides a self dissolving matrix that will last about two weeks in the body.

lower left photo provided by [BruceBlau](#), middle photo provided by [Zituba](#), and lower right photo provided by [Werneuchen](#)

Section 6.5: Proteins

Proteins are one of the most abundant organic molecules in living systems and have the most diverse range of functions of all macromolecules. Proteins may be structural, regulatory, contractile, or protective; they may serve in transport, storage, or membranes; or they may be toxins or enzymes. Each cell in a living system may contain thousands of different proteins, each with a unique function. Their structures, like their functions, vary greatly. They are all, however, polymers of amino acids, arranged in a linear sequence and connected together by covalent bonds.

Amino Acids and Primary Protein Structure

The major building block of proteins are called alpha (α) amino acids. As their name implies they contain a carboxylic acid functional group and an amine functional group. The alpha designation is used to indicate that these two functional groups are separated from one another by one carbon group. In addition to the amine and the carboxylic acid, the alpha carbon is also attached to a hydrogen and one additional group that can vary in size and length. In the diagram below, this group is designated as an R-group. Within living organisms there are 20 amino acids used as protein building blocks. They differ from one another only at the R-group position. The basic structure of an amino acid is shown below:

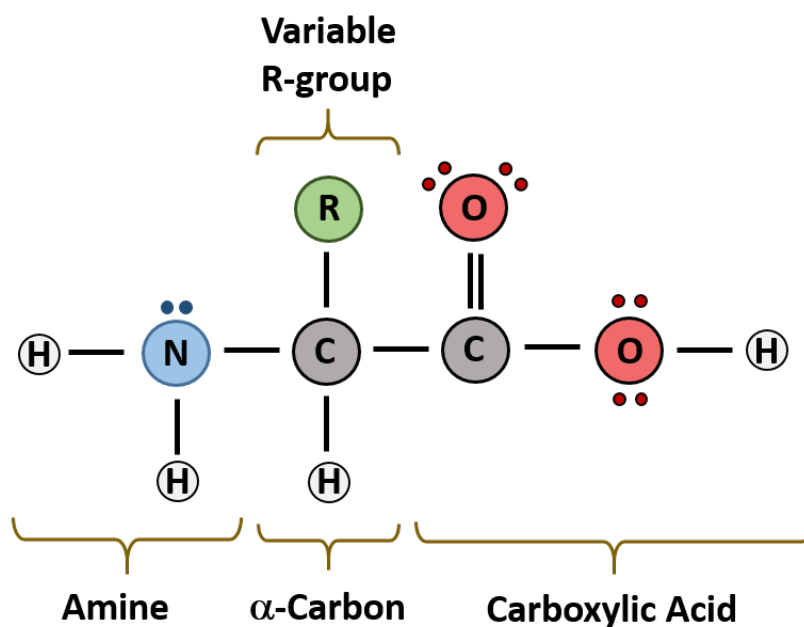

Figure 6.19 General Structure of an Alpha Amino Acid

Within cellular systems, proteins are linked together by a large enzyme complex that contains a mixture of RNA and proteins. This complex is called the ribosome. Thus, as the amino acids are linked together to form a specific protein, they are placed within a very specific order that is dictated by the genetic information contained within the messenger RNA molecule. This specific ordering of amino acids is known as the protein's primary sequence. The primary sequence of a protein is linked together using dehydration synthesis that combine the carboxylic acid of the upstream amino acid with the amine functional group of the downstream amino acid to form an amide linkage (Figure 6.20). Within protein structures, this amide linkage is known as the peptide bond. Subsequent amino acids will be added onto the carboxylic acid terminal of the growing protein. Thus, proteins are always synthesized in a directional manner starting with the amine and ending with the carboxylic acid tail. New amino acids are always added onto the carboxylic acid tail, never onto the amine of the first amino acid in the chain. The directionality of protein synthesis is dictated by the ribosome. In addition, because the R-groups can be quite bulky, they usually alternate on either side of the growing protein chain in the trans conformation. The cis conformation is only preferred with one specific amino acid known as proline.

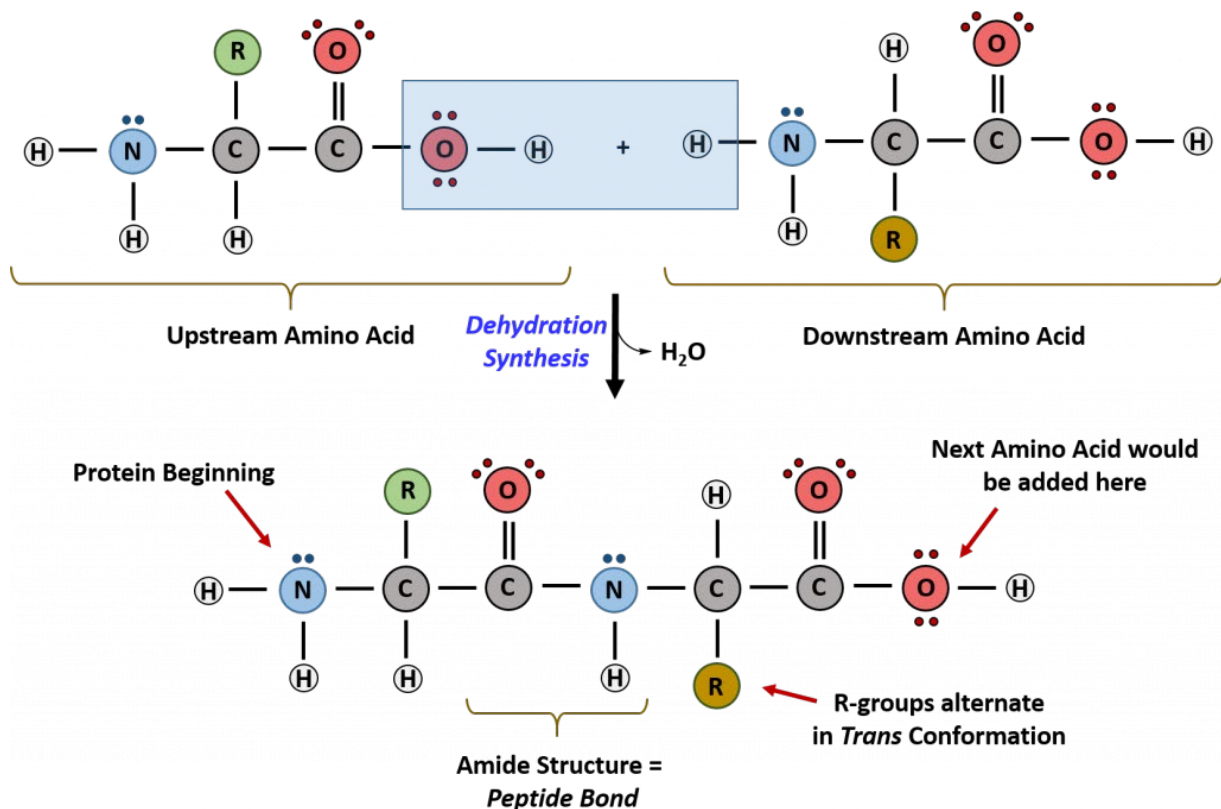

Figure 6.20 Formation of the Peptide Bond. The addition of two amino acids to form a peptide requires dehydration synthesis.

Proteins are very large molecules containing many amino acid residues linked together in very specific order. Proteins range in size from 50 amino acids in length to the largest known protein containing 33,423 amino acids. Macromolecules with fewer than 50 amino acids are known as peptides.

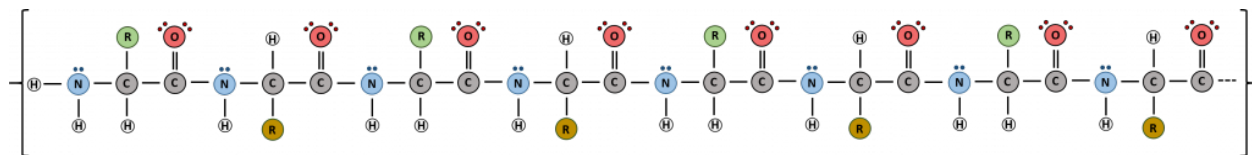
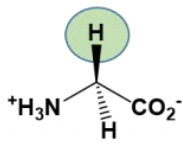

Figure 6.21 Peptides and Proteins are macromolecules built from long chains of amino acids joined together through amide linkages.

The identity and function of a peptide or a protein is determined by the primary sequence of amino acids within its structure. There are a total of 20 alpha amino acids that are commonly incorporated into protein structures (Figure 6.22). The different R-groups have different characteristics based on the nature of atoms incorporated into the functional groups. There are R-groups that only contain carbon and hydrogen and are very nonpolar or hydrophobic. Others contain polar uncharged functional groups such as alcohols, amides, and thiols. A few amino acids are basic (containing amine functional groups) or acidic (containing carboxylic acid functional groups). These amino acids are capable of forming full charges and can have ionic interactions. The order and nature of amino acids in the primary sequence of a protein determine the folding pattern of the protein based on the surrounding environment of the protein (ie if it is inside the cell, it is likely surrounded by water in a very polar environment, whereas if the protein is embedded in the plasma membrane, it will be surrounded by very nonpolar hydrocarbon tails).

Due to the large pool of amino acids that can be incorporated at each position within the protein, there are billions of different possible protein combinations that can be used to create novel protein structures! For example, think about a tripeptide made from this amino acid pool. At each position there are 20 different options that can be incorporated. Thus, the total number of resulting tripeptides possible would be $20 \times 20 \times 20$ or 20^3 , which equals 8,000 different tripeptide options! Now think about how many options there would be for a small peptide containing 40 amino acids. There would be 20^{40} options, or a mind boggling 1.09×10^{52} potential sequence options! Each of these options would vary in the overall protein shape, as the nature of the amino acid side chains helps to determine the interaction of the protein with the other residues in the protein itself and with its surrounding environment.

Nonpolar (Hydrophobic) Amino Acids



Glycine
Gly, G

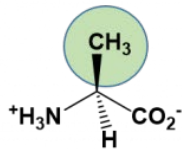

Alanine
Ala, A

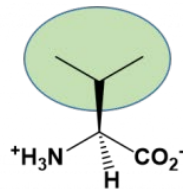

Valine
Val, V

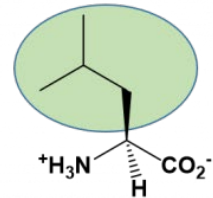

Leucine
Leu, L

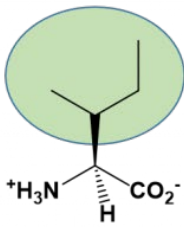

Isoleucine
Ile, I

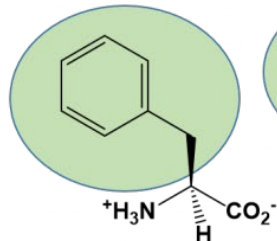

Phenylalanine
Phe, F

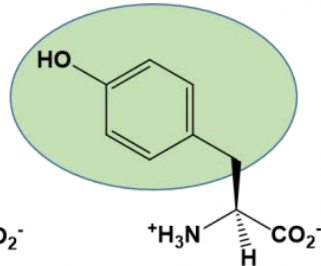

Tyrosine
Tyr, Y

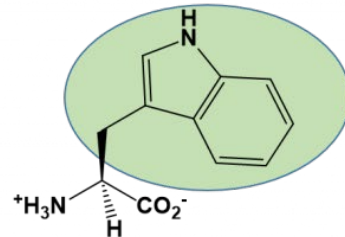

Tryptophan
Trp, W

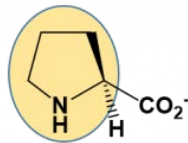

Proline
Pro, P

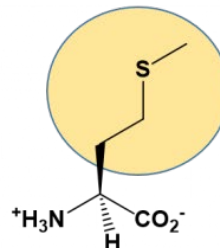

Methionine
Met, M

Polar (Hydrophilic) Amino Acids

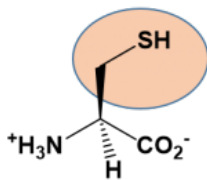

Cysteine
Cys, C

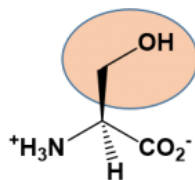

Serine
Ser, S

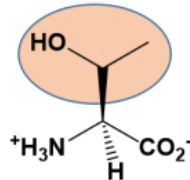

Threonine
Thr, T

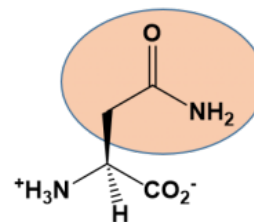

Asparagine
Asn, N

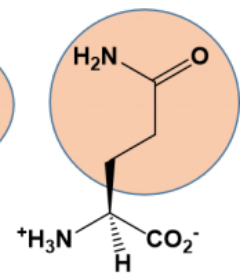

Glutamine
Gln, Q

Acidic Amino Acids

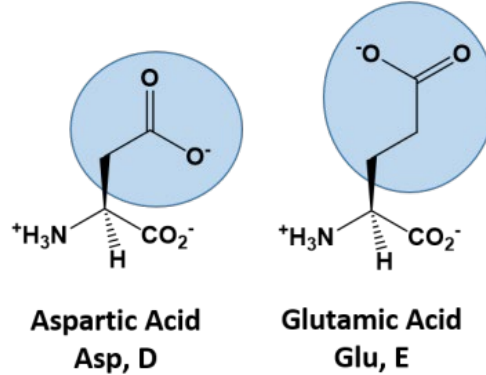

Basic Amino Acids

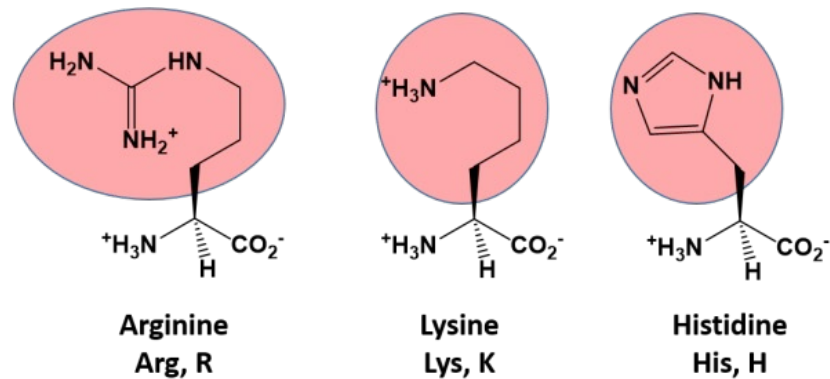

Figure 6.22 Structure of the 20 Alpha Amino Acids used in Protein Synthesis.

The character of the amino acids throughout the protein help the protein to fold and form its 3-dimensional structure. It is this 3-D shape that is required for the functional activity of the protein (ie. protein shape = protein function). For proteins found inside the watery environments of the cell, hydrophobic amino acids will often be found on the inside of the protein structure, whereas water-loving hydrophilic amino acids will be on the surface where they can hydrogen bond and interact with the water molecules. Proline is unique because it has the only R-group that forms a cyclic structure with the amine functional group in the main chain. This cyclization is what causes proline to adopt the **cis** conformation rather than the **trans** conformation within the backbone. This shift in structure will often mean that prolines are positions where bends or directional changes occur within the protein. Methionine is unique, in that it serves as the starting amino acid

for almost all of the many thousands of proteins known in nature. Cysteines contain thiol functional groups and thus, can be oxidized with other cysteine residues to form covalent disulfide bonds within the protein structure (Figure 6.23). Disulfide bridges add additional stability to the 3-D structure and are often required for correct protein folding and function (Figure 6.23).

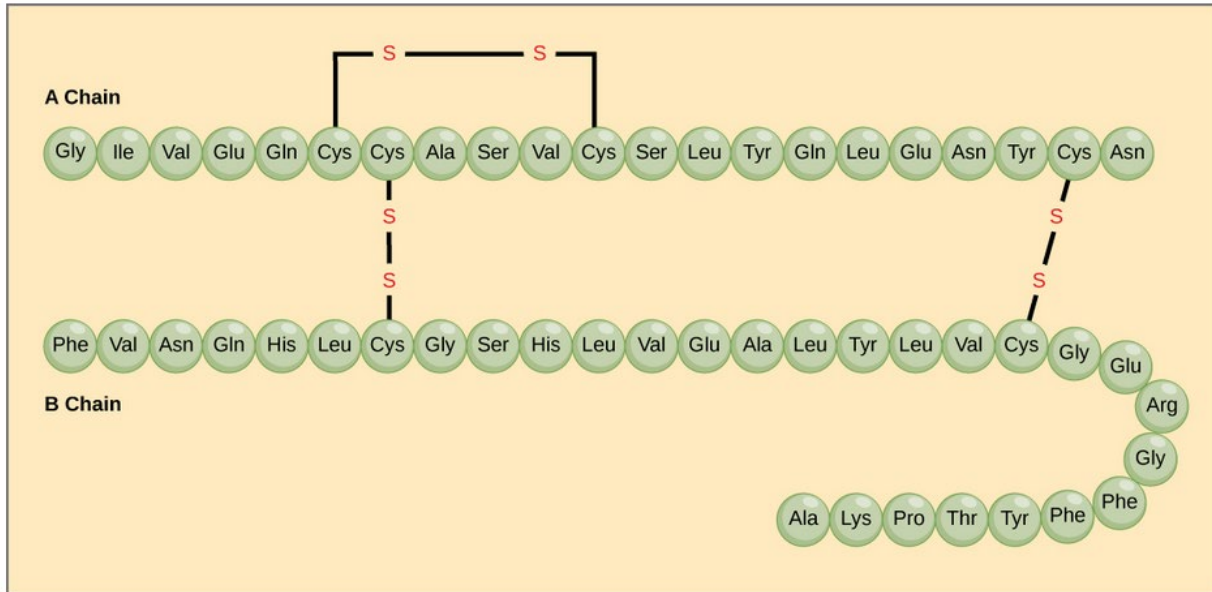

Figure 6.23 Disulfide Bonds. Disulfide bonds are formed between two cysteine residues within a peptide or protein sequence or between different peptide or protein chains. In the example above the two peptide chains that form the hormone insulin are depicted. Disulfide bridges between the two chains are required for the proper function of this hormone to regulate blood glucose levels.

Protein Shape and Function

The primary structure of each protein leads to the unique folding pattern that is characteristic for that specific protein. Recall that this is the linear order of the amino acids as they are linked together in the protein chain (Figure 6.24).

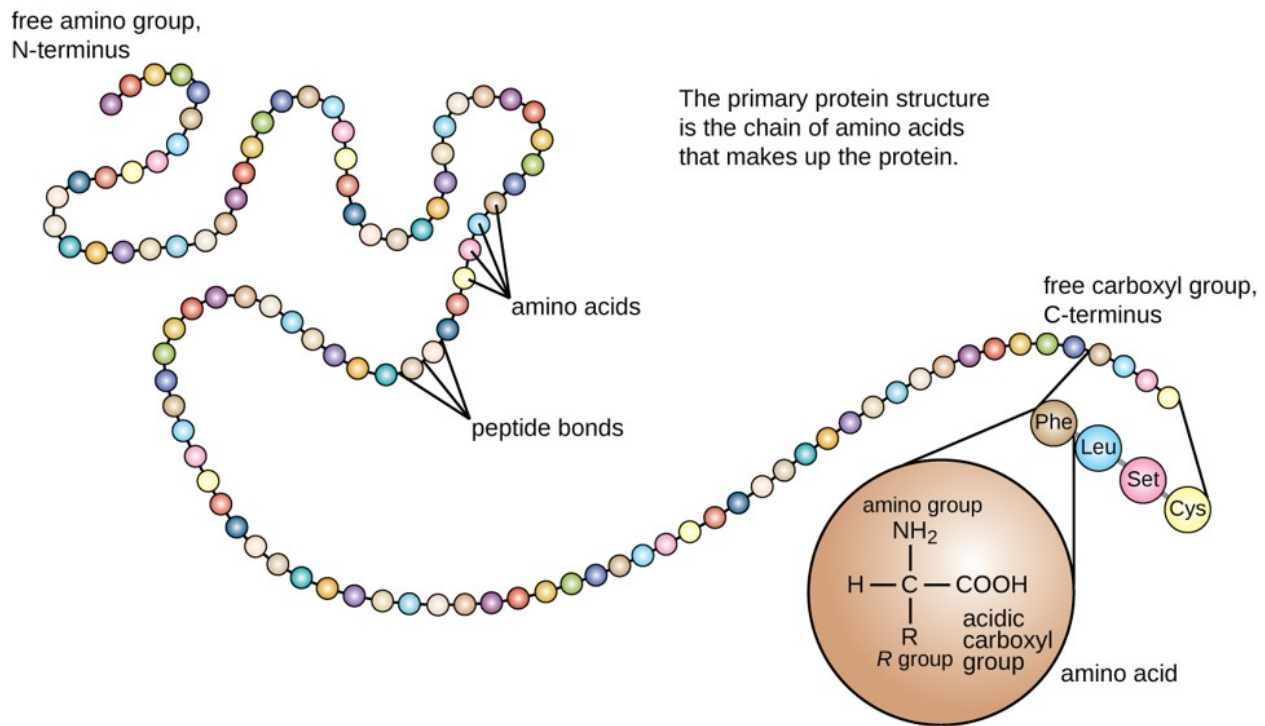

Figure 6.24 Primary protein structure is the linear sequence of amino acids.

(credit: modification of work by National Human Genome Research Institute)

Within each protein small regions may adopt specific folding patterns. These specific motifs or patterns are called secondary structure. Common secondary structural features include alpha helix and beta-pleated sheet (Figure 6.25). Within these structures, intramolecular interactions, especially hydrogen bonding between the backbone amine and carbonyl functional groups are critical to maintain 3-dimensional shape. Every helical turn in an alpha helix has 3.6 amino acid residues. The R groups (the variant groups) of the polypeptide protrude out from the α -helix chain. In the β -pleated sheet, the "pleats" are formed by hydrogen bonding between atoms on the backbone of the polypeptide chain. The R groups are attached to the carbons and extend above and below the folds of the pleat. The pleated segments align parallel or antiparallel to each other, and hydrogen bonds form between the partially positive nitrogen atom in the amino group and the partially negative oxygen atom in the carbonyl group of the peptide backbone. The α -helix and β -pleated sheet structures are found in most proteins and they play an important structural role.

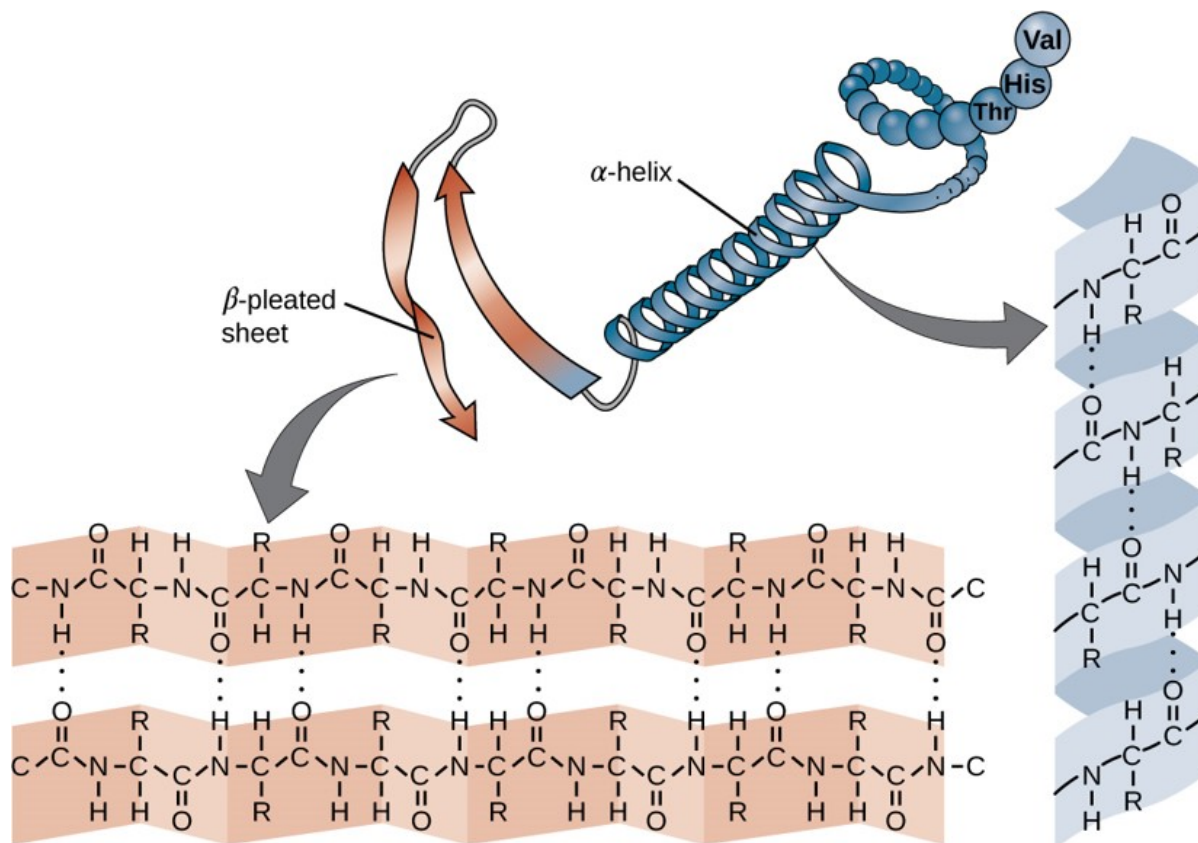

Figure 6.25 Secondary Structural Features in Protein Structure. The alpha helix and beta-pleated sheet are common structural motifs found in most proteins. They are held together by hydrogen bonding between the amine and the carbonyl oxygen within the amino acid backbone.

A Closer Look: Secondary Protein Structure in Silk

There were many trade routes throughout the ancient world. The most highly traveled and culturally significant of these was called the Silk Road. The Silk Road ran from the Chinese city of Chang'an all the way through India and into the Mediterranean and Egypt. The reason that the Silk road was so culturally significant was because of the great distance that it covered. Essentially the entire ancient world was connected by one trade route.



Figure 6.26 Silkworms

On the route many things were traded, including silk, spices, slaves, ideas, and gun powder. The silk road had an astounding effect on the creation of many societies. It was able to bring economic wealth into areas along the route, and new ideas traveled the distance and influence many things including art. An example of this is Buddhist art that was found in India. The painting has many western influences that can be identified in it, such as realistic musculature of the people being

Painted. Also, the trade of gun powder to the West helped influence warfare, and in turn shaped the modern world. The real reason the Silk Road was started though was for the product that it takes its name from: Silk.

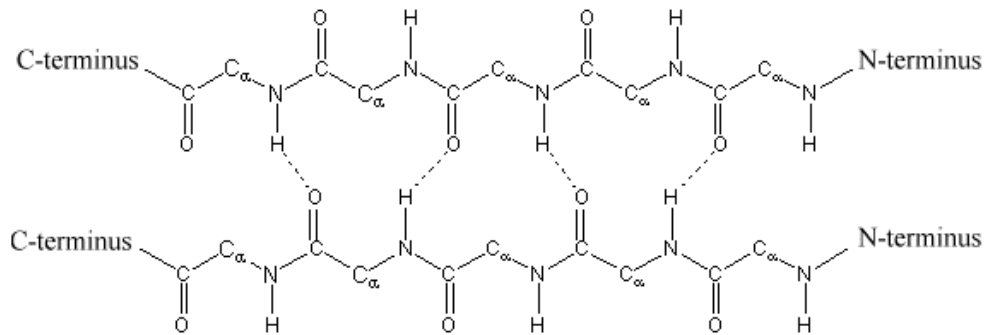

Figure 6.27 Land route in Red, Sea route in Blue

Silk was prized by the Kings and Queens of both European and Middle Eastern Society. The Silk showed that the rulers had power and wealth because the silk was not easy to come by, and therefore was definitely not cheap. Silk was first developed in China, and is made by harvesting the silk from the cocoons of the mulberry silkworm. The silk itself is called a natural protein fiber because it is composed of a pattern of amino acids in a secondary protein structure. The secondary structure of silk is the beta pleated sheet. The primary structure of silk contains the amino acids of

glycine, alanine, serine, in specific repeating pattern. These three amino acids make up 90% of the protein in silk. The last 10% is comprised of the amino acids glutamic acid, valine, and aspartic acid. These amino acids are used as side chains and affect things such as elasticity and strength. they also vary between various species. The beta pleated sheet of silk is connected by hydrogen bonds. The hydrogen bonds in the silk form beta pleated sheets rather than alpha helixes because of where the bonds occur. The hydrogen bonds go from the amide hydrogens on one protein chain to the corresponding carbonyl oxygen across the way on the other protein chain. This is in contrast to the alpha helix because in that structure the bonds go from the amide to the carbonyl oxygen, but they are not adjacent. The carbonyl oxygen is on the amino acid that is four residues before.

Parallel β Sheet



Antiparallel β Sheet

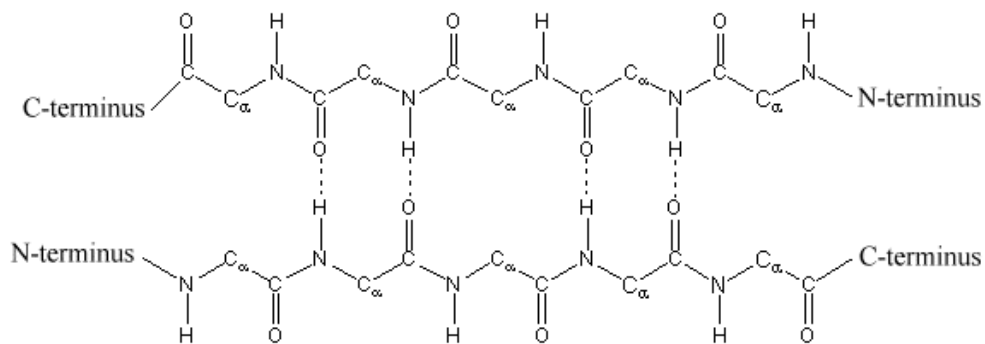

Figure 6.28 Parallel and Antiparallel Beta-Pleated Sheets

Silk is a great example of the beta pleated sheet structure. The formation of this secondary structure in the silk protein allows it to have very strong tensile strength. Silk also helped to form one of the greatest trading routes in history, allowing for the exchange of ideas, products and cultures while advancing the societies that were involved. Silk contains both anti-parallel and parallel arrangements of beta sheets. Unlike the α helix, though, the side chains are squeezed rather close together in a pleated-sheet arrangement. In consequence very bulky side chains make the structure unstable. This explains why silk is composed almost entirely of glycine, alanine, and serine, the three amino acids with the smallest side chains. Some species of silk worm produce varying amounts of bulky side chains, but these silks are not as prized as the mulberry silkworm (which has no bulky amino acid side chains) because the silk with bulky side chains is weaker and doesn't have as much tensile strength.

The complete 3-dimensional shape of the entire protein (or sum of all the secondary structures) is known as the tertiary structure of the protein and is a unique and defining feature for that protein (Figure 6.29). Primarily, the interactions among R groups creates the complex three-dimensional tertiary structure of a protein. The nature of the R groups found in the amino acids involved can counteract the formation of the hydrogen bonds described for standard secondary structures. For example, R groups with like charges are repelled by each other and those with unlike charges are attracted to each other (ionic bonds). When protein folding takes place, the hydrophobic R groups of nonpolar amino acids lay in the interior of the protein, whereas the hydrophilic R groups lay on the outside. The former types of interactions are also known as hydrophobic interactions. Interaction between cysteine side chains forms disulfide linkages in the presence of oxygen, the only covalent bond forming during protein folding.

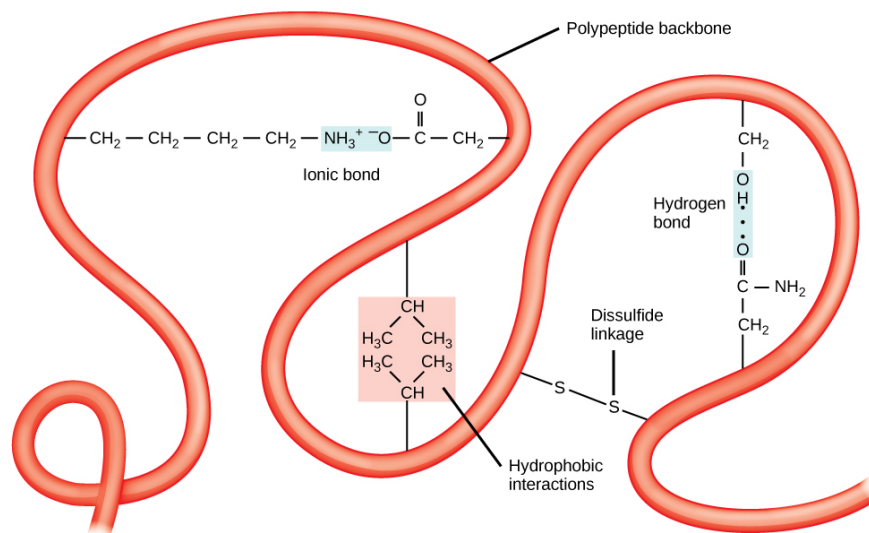

Figure 6.29 Tertiary Protein Structure. The tertiary structure of proteins is determined by a variety of chemical interactions. These include hydrophobic interactions, ionic bonding, hydrogen bonding and disulfide linkages.

All of these interactions, weak and strong, determine the final three-dimensional shape of the protein. When a protein loses its three-dimensional shape, it is usually no longer functional.

In nature, some proteins are formed from several polypeptides, also known as subunits, and the interaction of these subunits forms the quaternary structure. Weak interactions between the subunits help to stabilize the overall structure. For example, insulin (a

globular protein) has a combination of hydrogen bonds and disulfide bonds that cause it to be mostly clumped into a ball shape. Insulin starts out as a single polypeptide and loses some internal sequences during cellular processing that form two chains held together by disulfide linkages as shown in figure 6.23. Three of these structures are then grouped further forming an inactive hexamer (Figure 6.30). The hexamer form of insulin is a way for the body to store insulin in a stable and inactive conformation so that it is available for release and reactivation in the monomer form.

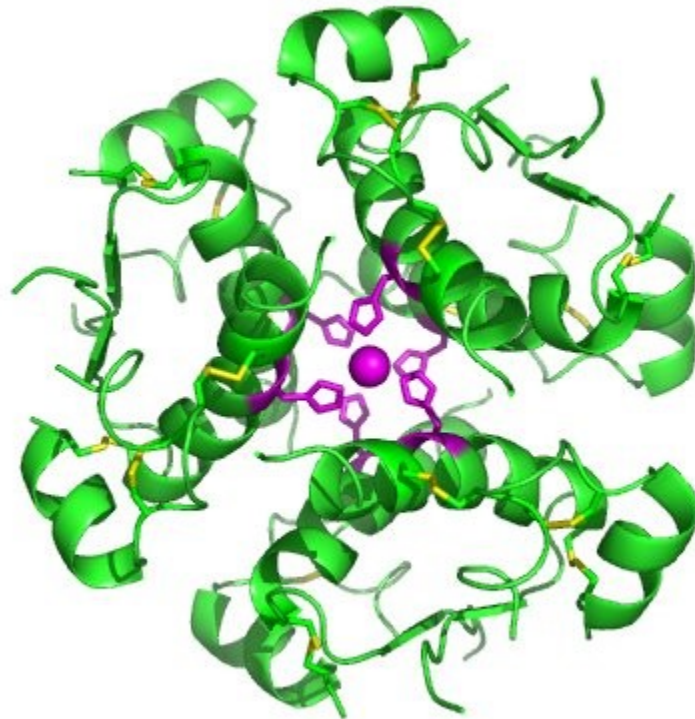

Figure 6.30 The Insulin Hormone is a Good Example of Quaternary Structure. Insulin is produced and stored in the body as a hexamer (a unit of six insulin molecules), while the active form is the monomer. The hexamer is an inactive form with long-term stability, which serves as a way to keep the highly reactive insulin protected, yet readily available.

Figure By: [Isaac Yonemoto](#)

The four levels of protein structure (primary, secondary, tertiary, and quaternary) are summarized in Figure 6.31.

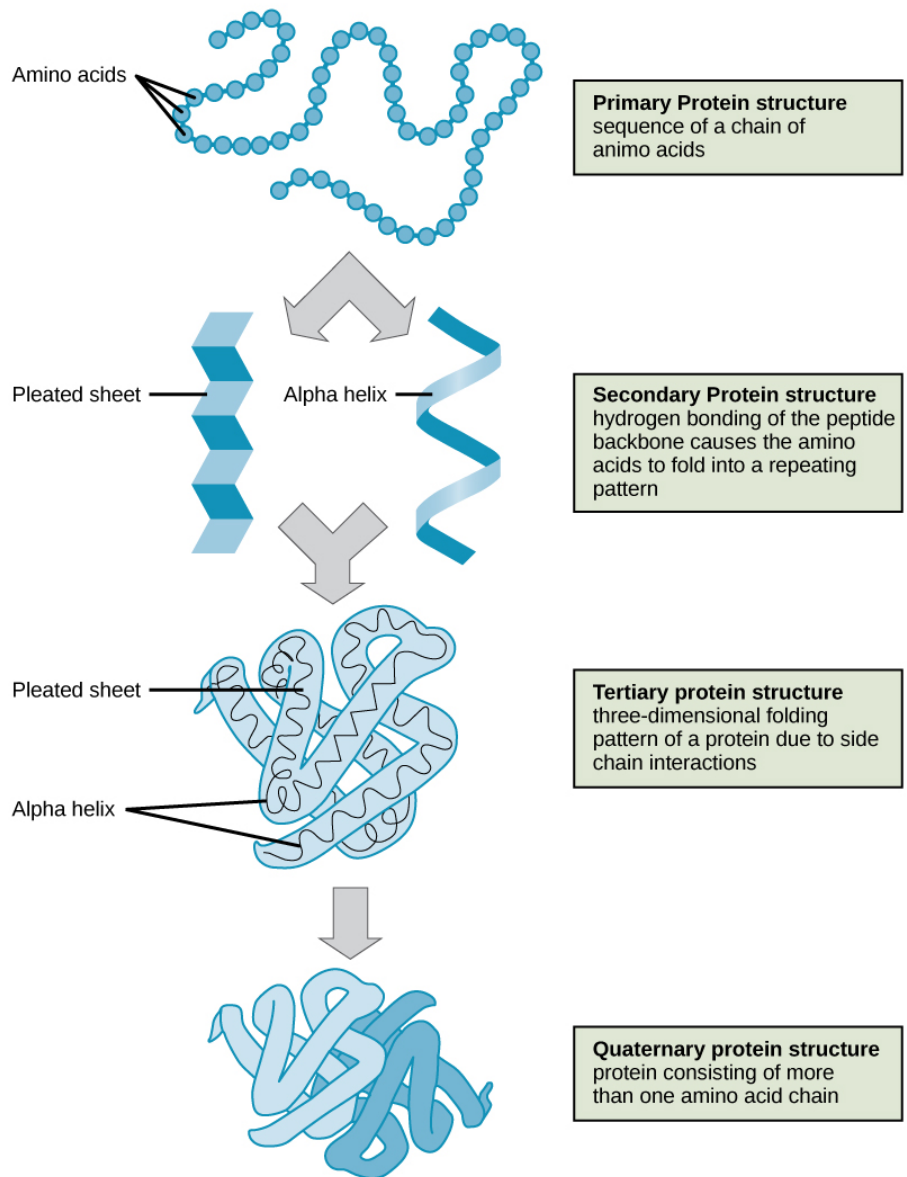

Figure 6.31 The four levels of protein structure can be observed in these illustrations. (credit: modification of work by National Human Genome Research Institute)

Hydrolysis is the breakdown of the primary protein sequence by the addition of water to reform the individual amino acids monomer units.

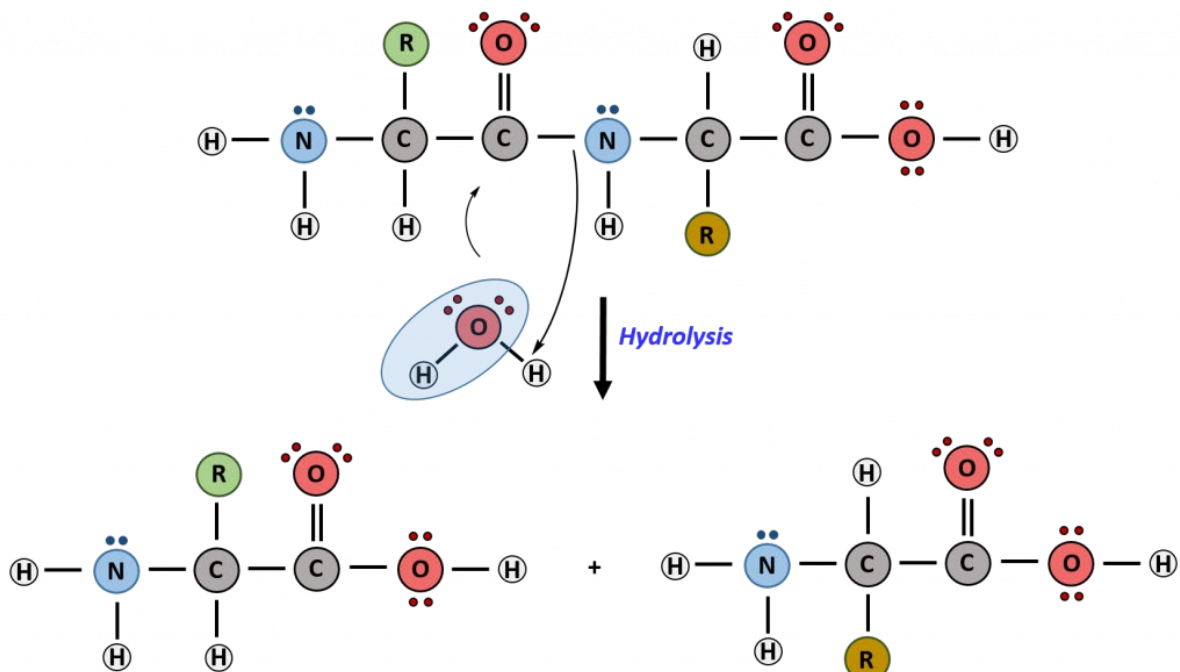

Figure 6.32 Hydrolysis of Proteins. In the hydrolysis reaction, water is added across the amide bond incorporating the -OH group with the carbonyl carbon and reforming the carboxylic acid. The hydrogen from the water reforms the amine.

If the protein is subject to changes in temperature, pH, or exposure to chemicals, the protein structure may unfold, losing its shape without breaking down the primary sequence in what is known as **denaturation** (Figure 6.33). **Denaturation** is different from hydrolysis, in that the primary structure of the protein is not affected. **Denaturation** is often reversible because the primary structure of the polypeptide is conserved in the process if the denaturing agent is removed, allowing the protein to refold and resume its function. Sometimes, however, denaturation is irreversible, leading to a permanent loss of function. One example of irreversible protein denaturation is when an egg is fried. The albumin protein in the liquid egg white is denatured when placed in a hot pan. Note that not all proteins are denatured at high temperatures; for instance, bacteria that survive in hot springs have proteins that function at temperatures close to boiling. The stomach is also very acidic, has a low pH, and denatures proteins as part of the digestion process; however, the digestive enzymes of the stomach retain their activity under these conditions.

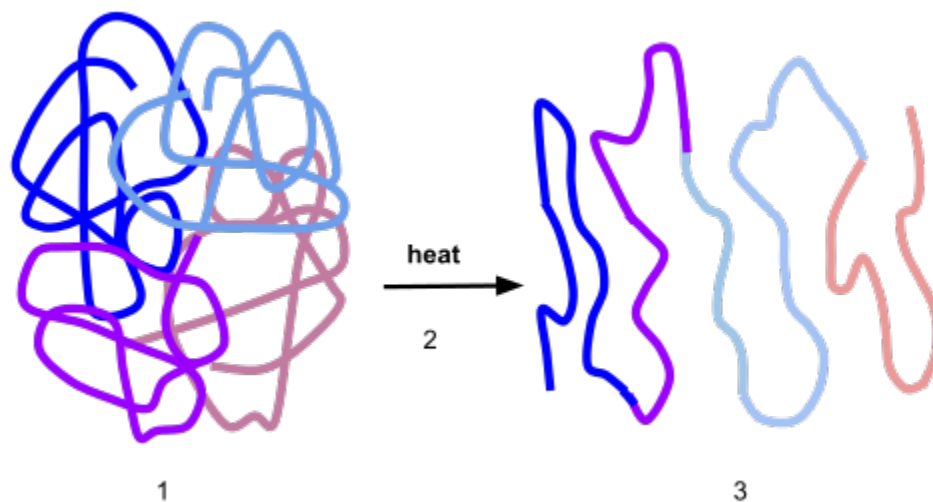

Figure 6.33 Protein Denaturation. Figure (1) depicts the correctly folded intact protein. Step (2) applies heat to the system that is above the threshold of maintaining the intramolecular protein interactions. Step (3) shows the unfolded or denatured protein. Colored regions in the denatured protein correspond to the colored regions of the natively folded protein shown in (1).

Diagram provided by: [Scurran15](#)

Protein folding is critical to its function. It was originally thought that the proteins themselves were responsible for the folding process. Only recently was it found that often they receive assistance in the folding process from protein helpers known as **chaperones (or chaperonins)** that associate with the target protein during the folding process. They act by preventing aggregation of polypeptides that make up the complete protein structure, and they disassociate from the protein once the target protein is folded.

Proteins are involved in many cellular functions. Proteins can act as enzymes which enhance the rate of chemical reactions. In fact, 99% of enzymatic reactions within a cell are mediated by proteins. Thus, they are integral in the processes of building up or breaking down of cellular components. Proteins can also act as structural scaffolding within the cell, helping to maintain cellular shape. Proteins can also be involved in cellular signaling and communication, as well as the transport of molecules from one location to another. Under extreme circumstances such as starvation, proteins can also be used as an energy source within the cell.

Review Questions:

1. What type of protein facilitates or accelerates chemical reactions?

1. an enzyme
2. a hormone
3. a membrane transport protein
4. a tRNA molecule

2. What are the monomers that make up proteins called?

1. amino acids
2. chaperones
3. disaccharides
4. nucleotides

3. Where is the linkage made that combines two amino acids?

1. between the R group of one amino acid and the R group of the second
2. between the carboxyl group of one amino acid and the amino group of the other
3. between the 6 carbon of both amino acids
4. between the nitrogen atoms of the amino groups in the amino acids

4. The alpha-helix and the beta-pleated sheet are part of which protein structure?

1. the primary structure
2. the secondary structure
3. the tertiary structure
4. the quaternary structure

5. Which of the following may cause a protein to denature?

1. changes in pH
2. high temperatures
3. all of the above
4. the addition of some chemicals

6. How do the differences in amino acid sequences lead to different protein functions?

1. Different amino acids produce different proteins based on the bonds formed between them.

2. Differences in amino acids lead to the recycling of proteins, which produces other functional proteins.
 3. Different amino acids cause rearrangements of amino acids to produce a functional protein.
 4. Differences in the amino acids cause post-translational modification of the protein, which reassembles to produce a functional protein.
7. What causes the changes in protein structure through the three or four levels of structure?
1. The primary chain forms secondary α -helix and β -pleated sheets which fold onto each other forming the tertiary structure.
 2. The primary structure undergoes alternative splicing to form secondary structures, which fold on other protein chains to form tertiary structures.
 3. The primary structure forms secondary α -helix and β -pleated sheets. This further undergoes phosphorylation and acetylation to form the tertiary structure.
 4. The primary structure undergoes alternative splicing to form a secondary structure, and then disulfide bonds give way to tertiary structures.

Section 6.6: Nucleic Acids

Nucleic acids are key macromolecules in the continuity of life. They carry the genetic blueprint of a cell and carry instructions for the functioning of the cell. The two main types of **nucleic acids** are **deoxyribonucleic acid (DNA)** and **ribonucleic acid (RNA)**. DNA is the genetic material found in all living organisms, ranging from single-celled bacteria to multicellular mammals. The other type of nucleic acid, RNA, is mostly involved in protein synthesis. The DNA molecules never leave the nucleus, but instead use an RNA intermediary to communicate with the rest of the cell. Other types of RNA are also involved in protein synthesis and its regulation. We will be going into more detail about nucleic acids in a later section.

DNA and RNA are made up of monomers known as **nucleotides** connected together in a chain with covalent bonds. Each nucleotide is made up of three components: a nitrogenous base, five-carbon sugar, and a phosphate group (**Figure 6.34**). The nitrogenous base in one nucleotide is attached to the sugar molecule, which is attached to the phosphate group.

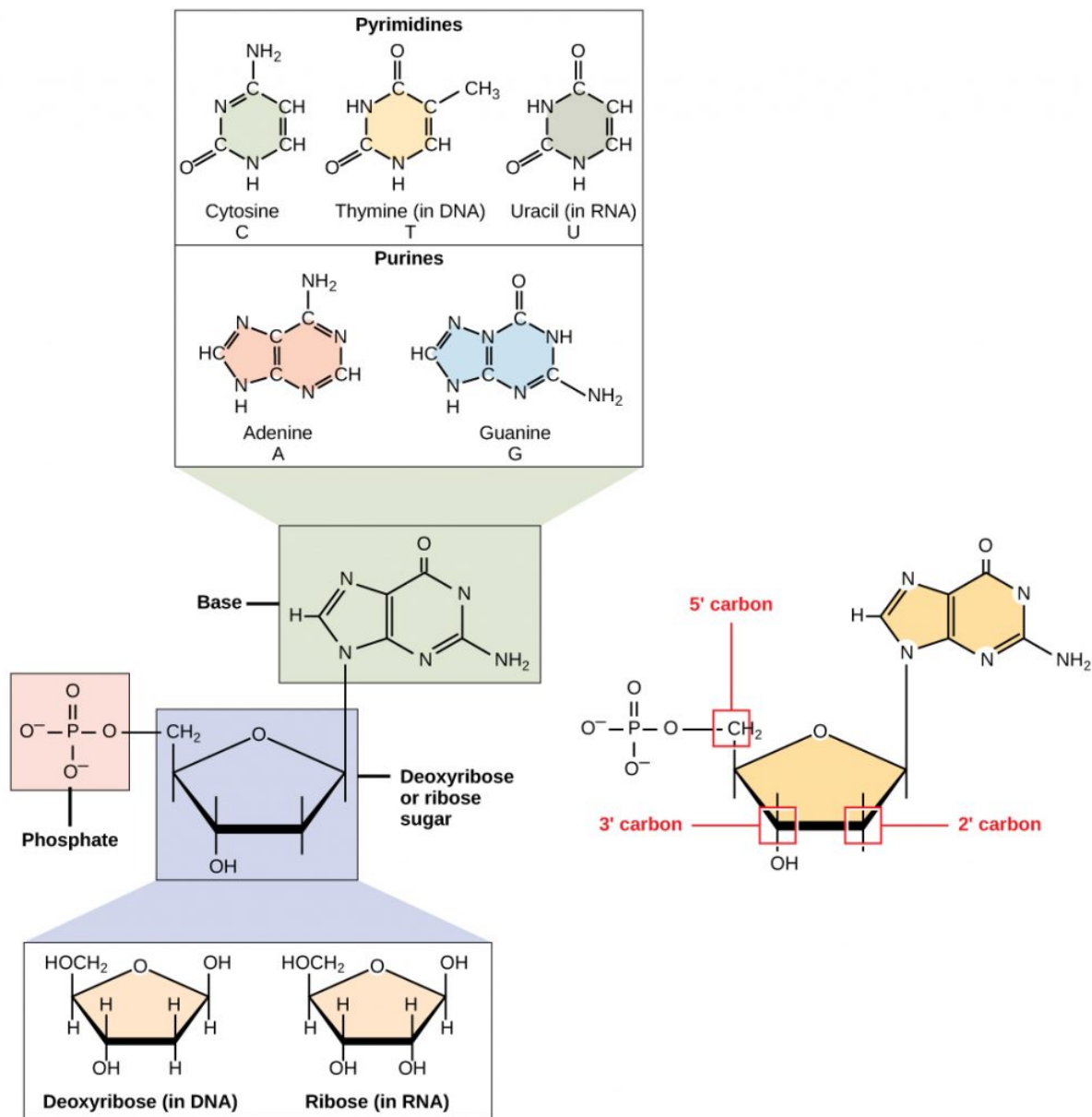

Figure 6.34 The Monomers of DNA. A nucleotide is made up of three components: a nitrogenous base, a pentose sugar, and one or more phosphate groups.

Each nucleotide in DNA contains one of four possible nitrogenous bases: adenine (A), guanine (G) cytosine (C), and thymine (T). RNA contains the base uracil (U) instead of thymine. The order of the bases in a nucleic acid determines the information that the molecule of DNA or RNA carries. This is because the order of the bases in a DNA gene determines the order that amino acids will be assembled together to form a protein.

The pentose sugar in DNA is deoxyribose, and in RNA, the sugar is ribose (Figure 6.34). The difference between the sugars is the presence of the hydroxyl group on the second carbon of the ribose and hydrogen on the second carbon of the deoxyribose. The carbon atoms of the sugar molecule are numbered as 1', 2', 3', 4', and 5' (1' is read as "one prime"). The phosphate residue is attached to the hydroxyl group of the 5' carbon of one sugar and the hydroxyl group of the 3' carbon of the sugar of the next nucleotide, which forms a 5'–3' phosphodiester linkage (a specific type of covalent bond). A polynucleotide may have thousands of such phosphodiester linkages.

DNA Double-Helical Structure

DNA has a double-helical structure (Figure 6.35). It is composed of two strands, or chains, of nucleotides. The double helix of DNA is often compared to a twisted ladder. The strands (the outside parts of the ladder) are formed by linking the phosphates and sugars of adjacent nucleotides with strong covalent bonds. The rungs of the twisted ladder are made up of the two bases attached together with a weaker intermolecular **hydrogen bonds**. Two bases hydrogen bonded together is called a **base pair**. The ladder twists along its length, hence the "double helix" description, which means a double spiral.

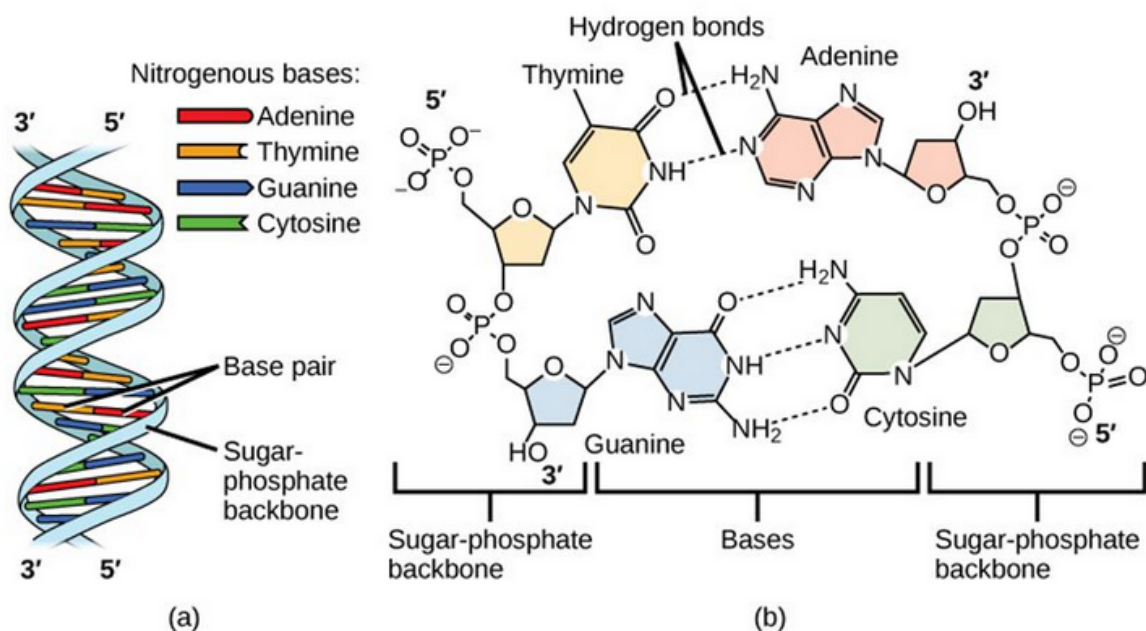

Figure 6.35 The Helical Structure of DNA. (a) DNA forms a double-stranded helix, and (b) adenine pairs with thymine forming two hydrogen bonds and cytosine pairs with guanine forming three hydrogen bonds. This figure is modified from work by [Jerome Walker and Dennis Myts](#).

The alternating sugar and phosphate groups lie on the outside of each strand, forming the backbone of the DNA. The nitrogenous bases are stacked in the interior, like the steps of a staircase, and these bases pair; the pairs are bound to each other by hydrogen bonds. The bases pair in such a way that the distance between the backbones of the two strands is the same all along the molecule.

The major function of both DNA and RNA is to store and carry genetic information. The specific order of nucleotides in the molecule of DNA or RNA is what determines the genetic information it carries. You can think of it like letters in a book – if the order of the letters were changed, the book would no longer contain the same (or correct) information.

Section 6.7: Secondary metabolites

Secondary metabolites, in contrast to primary metabolites are dispensable and not absolutely required for survival. Furthermore, secondary metabolites typically have a narrow species distribution. For example, the deadly nightshade, [Atropa belladonna](#), produces toxic hallucinogenic compounds, like scopolamine, but other plant species do not have this capacity. To date hundreds of thousands of secondary metabolites have been discovered!

Secondary metabolites have a broad range of functions. These include **pheromones** that act as social signaling molecules with other individuals of the same species, other communication molecules that attract and activate symbiotic organisms, agents that solubilize and transport nutrients, known as siderophores, and competitive weapons (repellants, venoms, toxins etc.) that are used against competitors, prey, and predators. The function of many other secondary metabolites is unknown. One hypothesis is that they confer a competitive advantage to the organism that produces them. An alternative view is that, in analogy to the immune system, these secondary metabolites have no specific function, but having the machinery in place to produce these diverse chemical structures is important. A few secondary metabolites are, therefore, produced and selected for depending on what the organism is exposed to during its lifetime.

Secondary metabolites have a diversity of structures and include examples such as alkaloids, phenylpropanoids, polyketides and terpenoids, as shown in Figure 6.36. [Alkaloids](#) are secondary metabolites that contain nitrogen as a component of their organic structure and can be divided into many subclasses of compounds. [Nicotine](#), the addictive substance in tobacco is provided as an example alkaloid (Fig 6.36). The [Phenylpropanoids](#) are a diverse family of organic compounds that are synthesized from

the amino acids phenylalanine and tyrosine (phenylalanine is shown in Figure 6.36). **Cinnamic acid** one of the volatile flavor molecules found in cinnamon is a phenylpropanoid. **Polyketides** are assembled from the building blocks of acetate and malonate to form large, complex structures. **Aflatoxin B1**, shown below, is a polyketide structure produced by fungi from the **Aspergillus** genus. These types of molds commonly grow on stored food crops, such as corn and peanuts and contaminate them with aflatoxins. Aflatoxins damage DNA molecules and act as a **carcinogen**, or cancer causing agent. Food crops contaminated with aflatoxins have been linked with cases of liver cancer. **Terpenoids** are another large class of natural products that are constructed from 5-carbon monomer units called isoprene (Fig 6.36). **Natural rubber** is a good example of a terpenoid-based structure. It is assembled from multiple repeating isoprene units (Fig 6.36). As we explore organic structures in more detail in the next few chapters we will continue to evaluate examples from these diverse classes of metabolites and how they impact our lives.

Section 6.8: Where Do We Find Secondary Natural Products?

Natural products may be extracted from the cells, tissues, and secretions of microorganisms, plants and animals. A crude (unfractionated) extract from any one of these sources will contain a range of structurally diverse and often novel chemical compounds. Chemical diversity in nature is based on biological diversity, so researchers travel around the world obtaining samples to analyze and evaluate in drug discovery screens or bioassays. This effort to search for natural products is known as bioprospecting.

The discipline of **pharmacognosy**, which is the study of natural products with biological activity, provides the tools to identify, select and process natural products destined for medicinal use. Usually, a natural extract has some form of biological activity that can be detected and attributed to a single compound or a set of related compounds produced by the organism. These active compounds can be used in drug discovery and development directly as they are, or they may be synthetically modified to enhance biological properties or reduce side effects. Examples of biological sources used to find new natural products are described below.

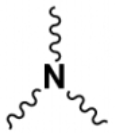
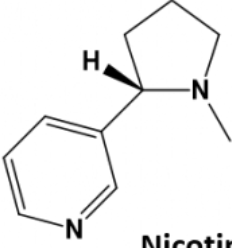
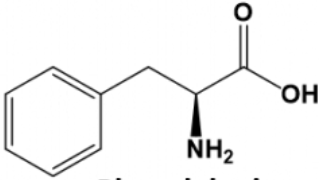
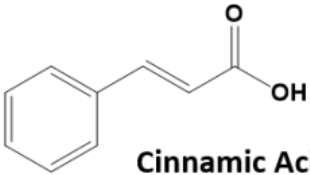
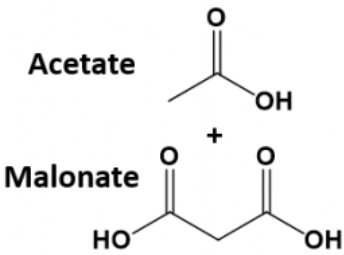
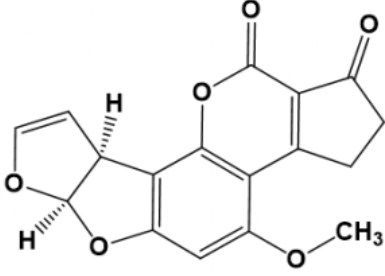
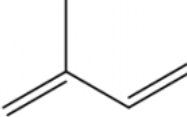
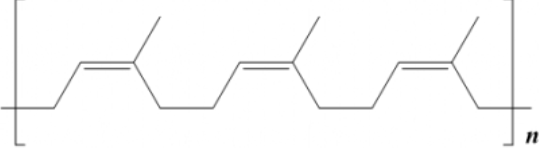
Compound Type	Building Block	Example
Alkaloids	 Nitrogen	 Nicotine
Phenylpropanoids	 Phenylalanine	 Cinnamic Acid
Polyketides	 Acetate Malonate	 Aflatoxin B1
Terpenoids	 Isoprene	 Natural Rubber

6.36. Representative examples of each of the major classes of secondary metabolites

Prokaryotic Organisms

A prokaryote is a unicellular organism that lacks a membrane-bound nucleus(karyon), mitochondria, or any other membrane-bound organelle. The word *prokaryote* comes from the Greek πρό (*pro*) "before" and καρύον (*karyon*) "nut" or "kernel". Prokaryotes can be divided into two domains, Archaea and Bacteria. In contrast, species with nuclei and organelles (Animals, Plants, Fungi and Protists) are placed in the domain Eukaryota.

Phylogenetic Tree of Life

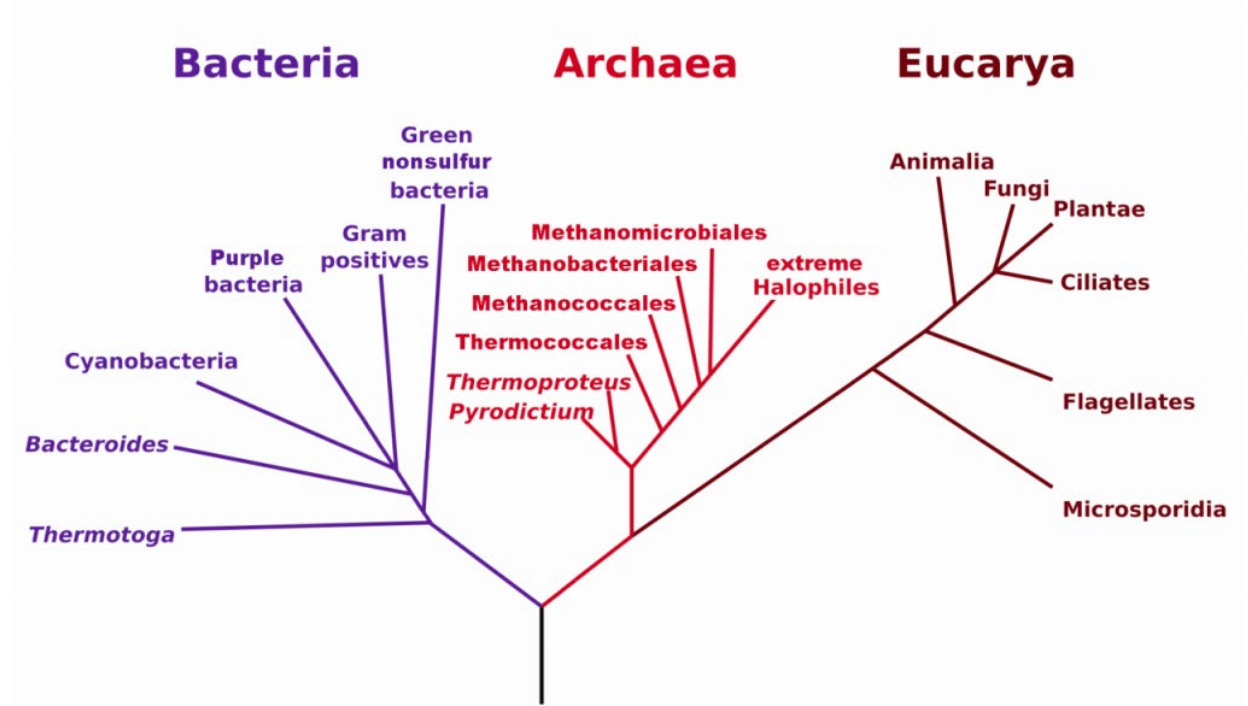

Figure 6.37. Phylogenetic Tree of Life Based on Genetic Sequencing of Ribosomal RNA. Developed by: [Maulucioni](#).

In the prokaryotes, all the intracellular water-soluble components (proteins, DNA and metabolites) are located together in the cytoplasm enclosed by the cell membrane, rather than in separate cellular compartments. Prokaryotes are also much smaller than eukaryotic cells.

Bacteria

Typically a few micrometres in length, [bacteria](#) have a number of shapes, ranging from spheres to rods and spirals. Bacteria were among the first life forms to appear on Earth, and are present in most of its habitats. Bacteria inhabit soil, water, acidic hot springs, radioactive waste, and the deep portions of Earth's crust. Bacteria also live in symbiotic and parasitic relationships with plants and animals. Most bacteria have not been characterised, and only about half of the bacterial phyla have species that can be grown in the laboratory. The study of bacteria is known as bacteriology, a branch of microbiology. There are typically 40 million bacterial cells in a gram of soil and a million bacterial cells in a millilitre of fresh water. Bacteria are a prominent source of natural products. Figure 6.38 shows a few examples of bacterial natural products that have had an impact on our society, including several antibiotics.

The serendipitous discovery and subsequent clinical success of penicillin prompted a large-scale search for other environmental microorganisms that might produce anti-infective natural products. Soil and water samples were collected from all over the world, leading to the discovery of streptomycin (derived from the bacterium, *Streptomyces griseus*), and the realization that bacteria, not just fungi, represent an important source of antibacterial natural products. This, in turn, led to the development of an impressive arsenal of antibacterial and antifungal agents including amphotericin B, chloramphenicol, erythromycin, neomycin B, daptomycin and tetracycline (all from *Streptomyces* spp.), the polymyxins (from *Paenibacillus polymyxa*), and the rifamycins (from *Amycolatopsis rifamycinica*).

Although most of the drugs derived from bacteria are employed as anti-infectives, some have found use in other fields of medicine. Botulinum toxin (from *Clostridium botulinum*) and bleomycin (from *Streptomyces verticillus*) are two examples. Botulinum toxin is the neurotoxin responsible for botulism food poisoning (Fig. 6.39). It is caused by the bacterium, *Clostridium botulinum*, which can grow in improperly sterilized canned meats and other preserved foods. The poisoning can be fatal depending on how much of the toxin is ingested. It causes muscle weakness and paralysis. This toxin is now used cosmetically to help reduce facial wrinkles. It is injected in small doses into areas such as the forehead to cause paralysis to the muscles that create wrinkles. Also, the glycopeptide bleomycin is used for the treatment of several cancers including Hodgkin's lymphoma, head and neck cancer, and testicular cancer. Newer trends in the field include the

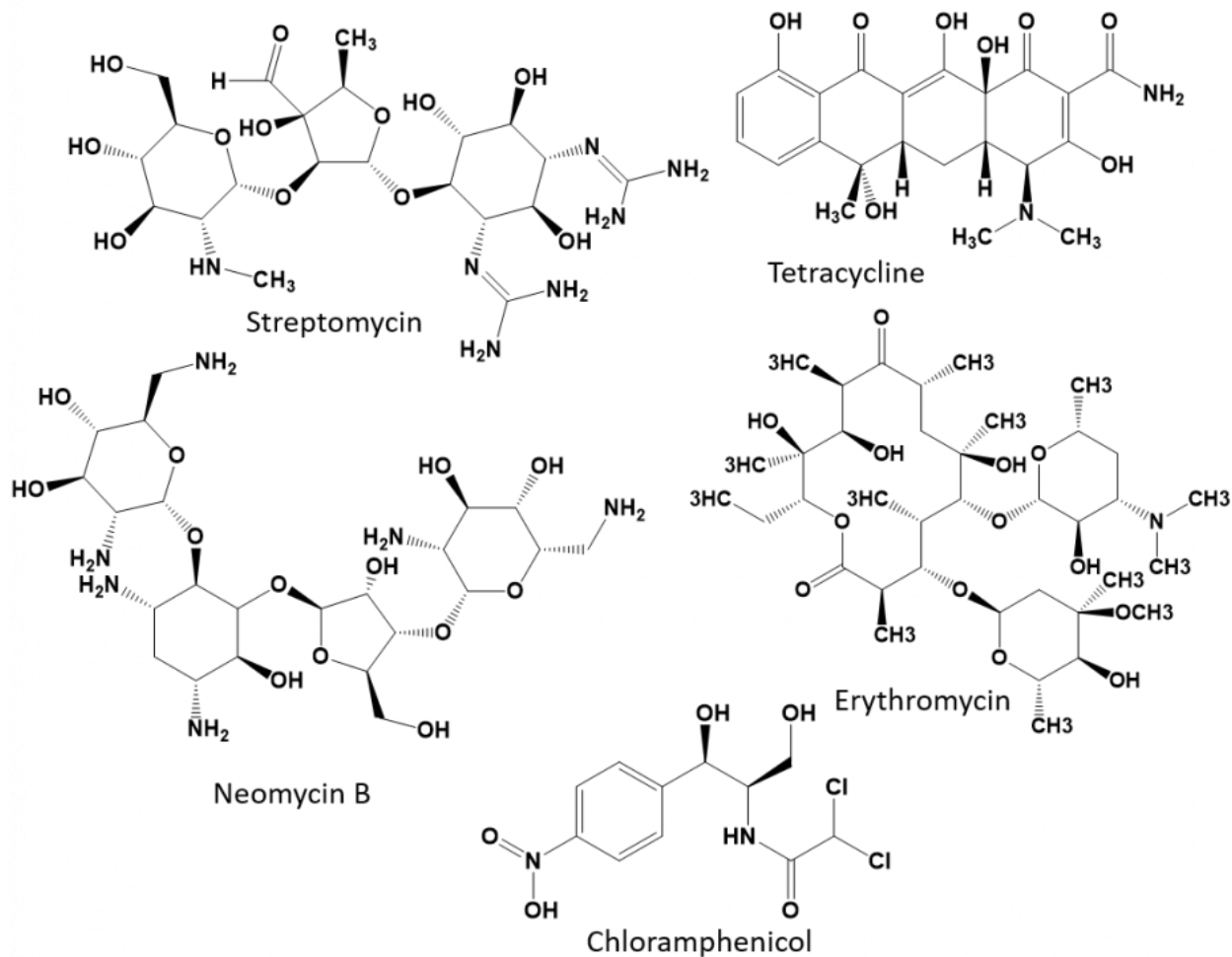

Figure 6.38. Bacteria isolated from soil are prolific producers of antibacterial compounds.

Soil photo by: Pam Dumas. Available at: [Flicker](#)

Soil bacteria photo by: Alexander Raths. Available at: [Shutterstock](#)

metabolic profiling and isolation of natural products from novel bacterial species present in underexplored environments. Examples include secondary metabolite discovery from **symbionts** or endophytes. Symbionts are organisms that live in close association with another, often larger, organism known as a host. **Endophytes** are non-harmful symbionts that are associated with plants for at least part of their life cycle. In addition, discovery of organisms from tropical environments, subterranean bacteria found deep underground via mining/drilling, and marine bacteria continue to add to the complexity of secondary metabolites discovered.

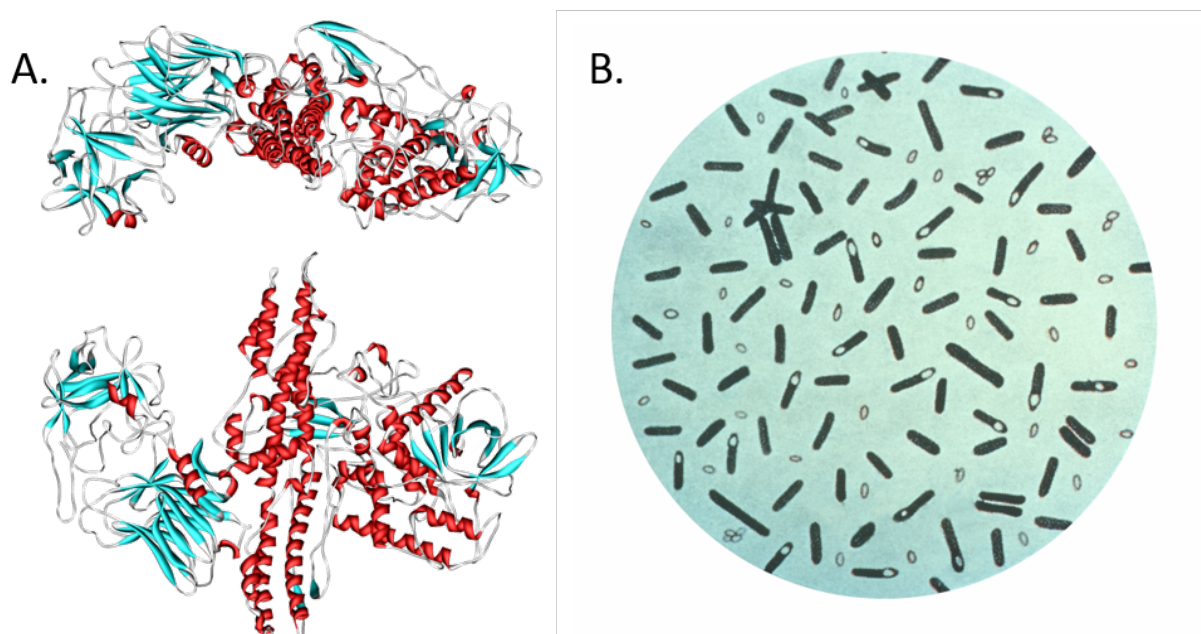

Figure 6.39. Botulinum toxin. (A) Diagram of botulinum toxin A. Consuming food products tainted with the neurotoxin produced by (B) the bacterium **Clostridium botulinum**, can cause paralysis and death. Interestingly, the neurotoxin (marketed as Botox, Dysport, Xeomin, and MyoBloc) has been adapted for medicinal use to reduce epileptic seizures and for cosmetic use to reduce wrinkles and frown lines by paralyzing muscle tissue in the forehead. Diagram (A) provided at [Wikipedia](#). Diagram (B) provided by the [CDC Prevention's Public Health Image Library](#)

Archaea

The discovery of organisms now classified as Archaea is fairly recent in our history, dating back to 1977 by the researchers, [Carl Woese](#) and [George E. Fox](#). Genetic sequencing was used to show that a separate branch of ancient prokaryotic organisms diverged at an early

stage in the history of life on Earth (Fig. 6.40). Thus, Woese suggested dividing the prokaryotic organisms into two major categories, Bacteria and Archaea, based on these genetic differences. It is noteworthy that many Archaea have adapted to life in extreme environments such as the polar regions, hot springs, acidic springs, alkaline springs, salt lakes, and the high pressure of deep ocean water. These Archaea species are known as extremophiles.

Before the discovery by Woese and Fox, scientists thought that prokaryotic extremophiles were bacteria evolved from common bacterial species that are more familiar to us. Now, evidence suggests that they are actually very ancient lifeforms, and may have robust evolutionary connections to early life forms on Earth. Woese's work on Archaea is significant in its implications for the search for life on other planets, as extremophiles may be hearty enough to exist in the extreme environments located on distant worlds. Because many Archaea have adapted to life in extreme environments they also possess enzymes that are functional under quite unusual conditions. These enzymes are of potential use in the food, chemical, and pharmaceutical industries, where biotechnological processes frequently involve high temperatures, extremes of pH, high salt concentrations, and / or high pressure.

For example, *Pyrococcus furiosus* is an extremophilic species of Archaea (Fig. 6.40). It can be classified as a **hyperthermophile** because it thrives best under extremely high temperatures—higher than those preferred of a thermophile. It is notable for having an optimum growth temperature of boiling water - 100°C (a temperature that would destroy most living organisms). Recently, [Dr. Tang's research group](#) isolated a thermostable enzyme from this species that can breakdown lactose, a disaccharide sugar found in milk (Fig. 6.40). Lactose intolerance is a common health concern causing gastrointestinal symptoms and avoidance of dairy products by afflicted individuals. Since milk is a primary source of calcium and vitamin D, lactose intolerant individuals often obtain insufficient amounts of these nutrients which may lead to adverse health outcomes. Production of lactose-free milk can provide a solution to this problem, although it requires use of lactase from microbial sources and increases potential for contamination. Use of thermostable lactase enzymes can overcome this issue by functioning under pasteurization conditions. Early explorations of this enzyme show that it has optimal activity at 100°C and that it is thermostable even at 110°C (Fig. 6.40).

Eukaryotic Organisms

Eukaryotic organisms include four major kingdoms: Protista, Fungi, Plantae, and Animalia (Fig 6.41). Fungi are heterotrophic, eukaryotic organisms, either single-celled or multicellular, that are primarily decomposers within the environment. Heterotrophs

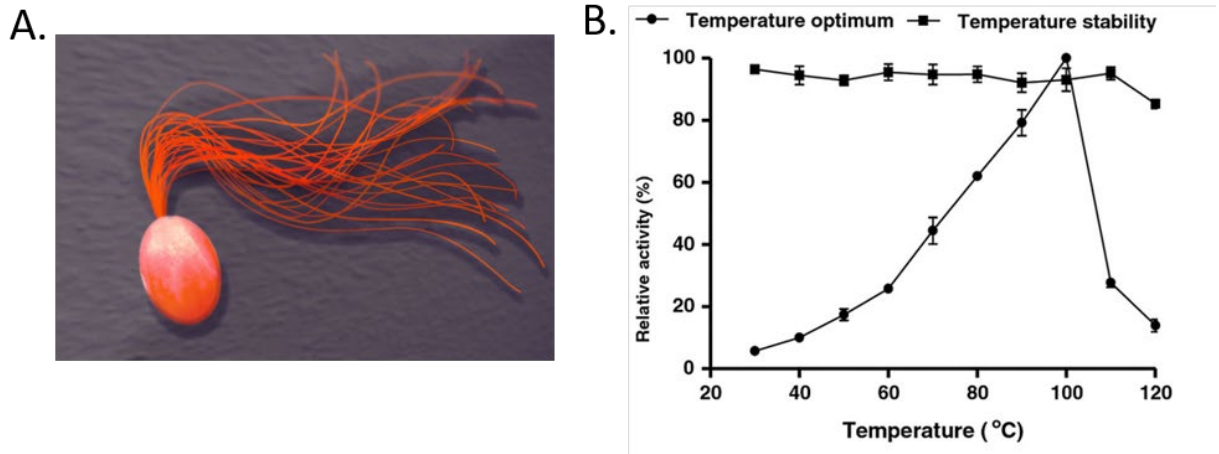

Figure 6.40 The Extremophile *Pyrococcus furiosus*. (A) Shows a computer recreation of **P. furiosus**. (B) Shows the effects of temperature on the stability of the lactase enzyme, β -glucosidase.

(A) [Recreation of *P. furiosus* by: Fulvio314](#) (B) Effects of temperature figure on **P. furiosus** lactase activity and text adapted from: [Li, et al. \(2013\) *BMC Biotechnol.* 13:73](#)

are organisms that cannot produce their own food. **Plants** are multicellular eukaryotic organisms that are **autotrophic**, or capable of producing their own food. Plants are also characterized by having true roots, stems and leaves. **Animals** are multicellular, eukaryotic organisms that are heterotrophic, and are characterized by being mobile at some point in their lifetime. The term Protista (or sometimes Protoctista) is still often used to describe all other eukaryotic organisms that do not fit in the Fungi, Plantae, or Animalia kingdoms. However, it is not an ideal grouping, as there are protists that are animal-like, plant-like and fungi-like grouped under one umbrella term. Many scientists prefer to reclassify the protist kingdom into sub-groupings of related organisms based on phylogenetic data, rather than use the older protist classification. In fact, the phylogenetic classification proposed by Carl Woese breaks Kingdom Protista into three major groups; the ciliates, the flagellates, and the microsporidia (Fig 6.37). In the following section, we will focus on natural product examples from the Fungi, Plant, and Animal kingdoms. However, keep in mind that many protists are also producers of interesting natural products.

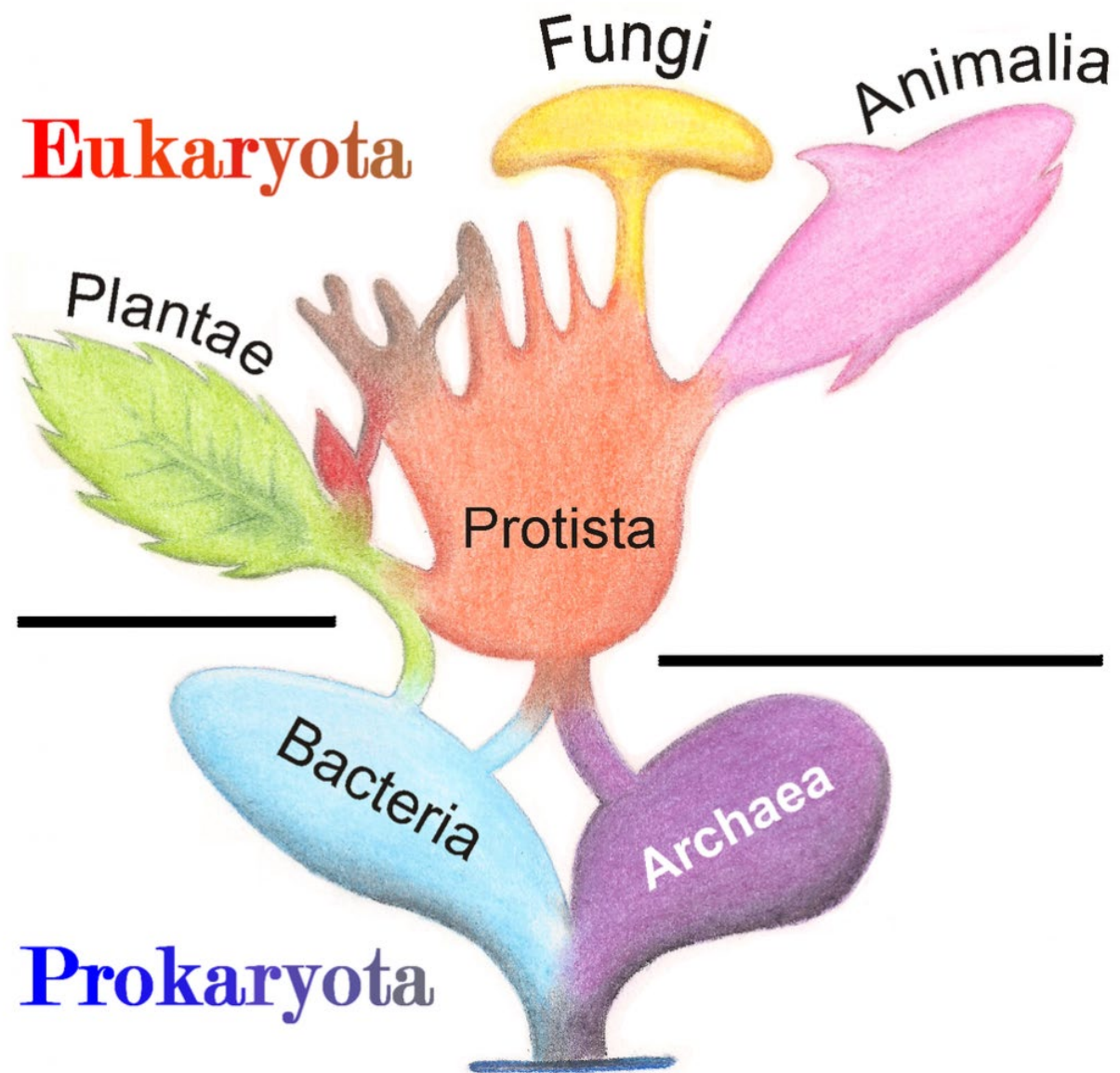

Figure 6.41 The Major Domains and Kingdoms of Life. By: [Maulucioni y Doridí](#)

Fungi

As mentioned above, [Fungi](#) are heterotrophic, eukaryotic organisms that are primarily decomposers within the environment. They include single-celled organisms such as yeast and molds, and multicellular organisms that have fruiting bodies, such as mushrooms. Fungi produce a myriad of secondary natural products. Some are very toxic and have

spurred common names such as death cap, destroying angel, and fool's mushroom. Others have found great utility in medicine. For example, several anti-infective medications have been derived from fungi including the [penicillins](#) and the [cephalosporins](#) (antibacterial drugs from [Penicillium chrysogenum](#) and [Cephalosporium acremonium](#), respectively), and [griseofulvin](#) (an antifungal drug from [Penicillium griseofulvum](#)) (Fig 6.42, parts A-C). Another medicinally useful fungal metabolite is [lovastatin](#) (from [Aspergillus terreus](#)), which became a lead for the statins, a series of drugs commonly used to lower cholesterol levels (Fig 6.42, part D).

[Ergometrine](#) (from [Claviceps spp.](#)) acts as a vasoconstrictor, and is used to prevent bleeding after childbirth (Fig 6.42, part E). You will notice in the photograph of **Claviceps spp.** that this genus of fungi commonly grows on grain crops such as wheat and

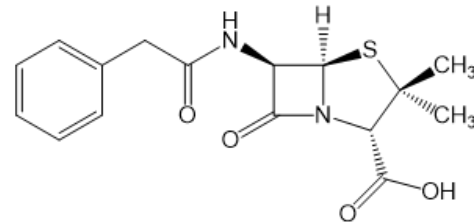

Penicillin G
(5 naturally occurring penicillins)

[\(By Crulina 98 \)](#)

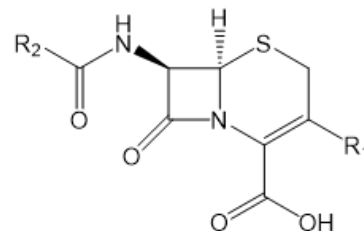

Cephalosporin Core Structure
(over 16 derivatives!)

[\(By Phil\)](#)

C.

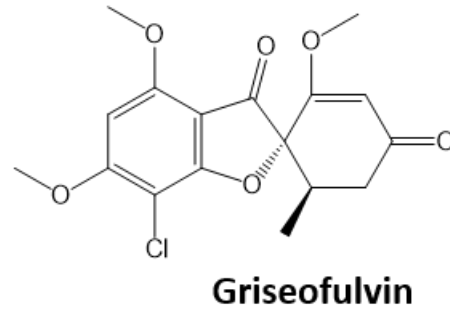
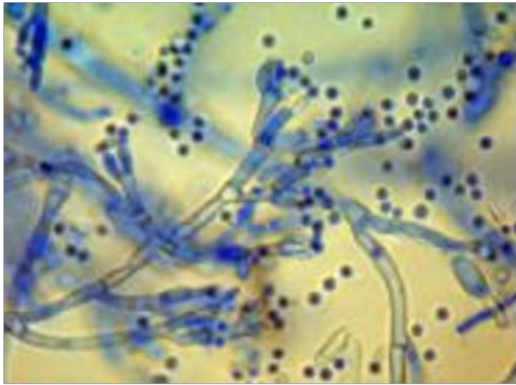

(By Schimmel)

D.

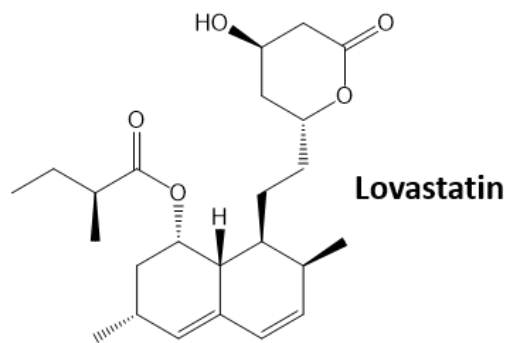

(By Medmyco at English Wikipedia)

E.

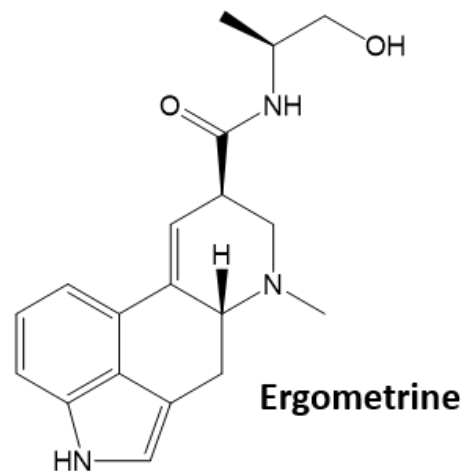

(By Dominique Jacquin)

Figure 6.42. Examples of fungal secondary metabolites.

barley. Contamination of grain crops with this fungi can lead to human poisoning if high quantities of the fungi are consumed. This type of poisoning is known as [ergotism](#) and can cause convulsions. The vasoconstrictive properties of ergometrine can also cause gangrenous side effects when ingested in toxic doses. Distal structures that are more poorly vascularized like the fingers and the toes are affected first. This can cause loss of peripheral sensation, edema, and ultimately the death and loss of affected tissues.

[Cyclosporin](#) is another amazing example of a fungal metabolite with important medical implications. Cyclosporin is an alkaloid structure that is assembled from amino acid building blocks that forms a cyclic peptide structure (Fig 6.43). Its major biological activity is to suppress the immune response. Thus, it is widely prescribed to patients following an organ transplant, to help reduce the chance of organ rejection. Cyclosporin was isolated in 1971 from the fungus [*Tolypocladium inflatum*](#) (Fig 6.43). After 12 years of laboratory investigations and clinical testing, it was approved by the FDA for use in 1983. It is on the [World Health Organization's List of Essential Medicines](#), as one of the most effective and safe medicines needed in a health system. Of note, **T. inflatum** is the asexual, single-celled form of a fungus that can also take on a sexually-reproducing multicellular life-stage, where it is known as the fungi, ***Cordyceps subsessilis*** (Fig 6.43). Cyclosporin is only produced during the asexual life-stage of the organism, demonstrating that gene expression can vary dramatically within an organism due to life-stage or other factors present within the environment of the organism.

Plants

Life forms that are classified in the Plant Kingdom are multicellular eukaryotic organisms that are **autotrophic**, or capable of producing their own food. They produce their own food through the process of **photosynthesis**, where they utilize light energy from the sun to convert carbon dioxide and water into simple sugars. Oxygen is a by-product of this reaction. Thus, plants are a major source of oxygen on the planet. It is estimated that there are approximately 250,000 to 300,000 different species of plants on the planet. In addition to producing oxygen and being utilized as a food source, plants are also a major source of complex and highly structurally diverse secondary metabolites. This structural diversity is attributed in part to the natural selection of organisms producing potent compounds to deter herbivory (feeding deterrents). Though the number of plants that have been extensively studied is relatively small, many pharmacologically active natural products have been identified and are currently used as medical treatments.

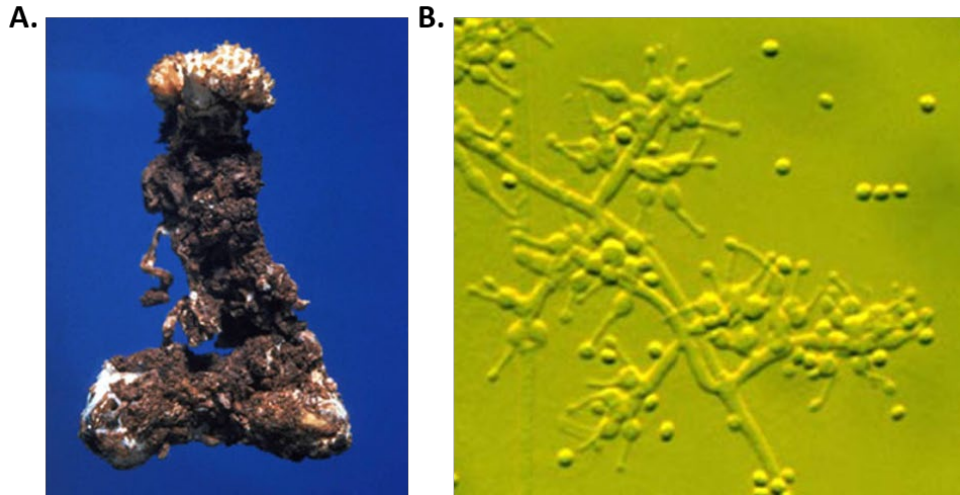

Photos By: [Kathie Hodge](#)

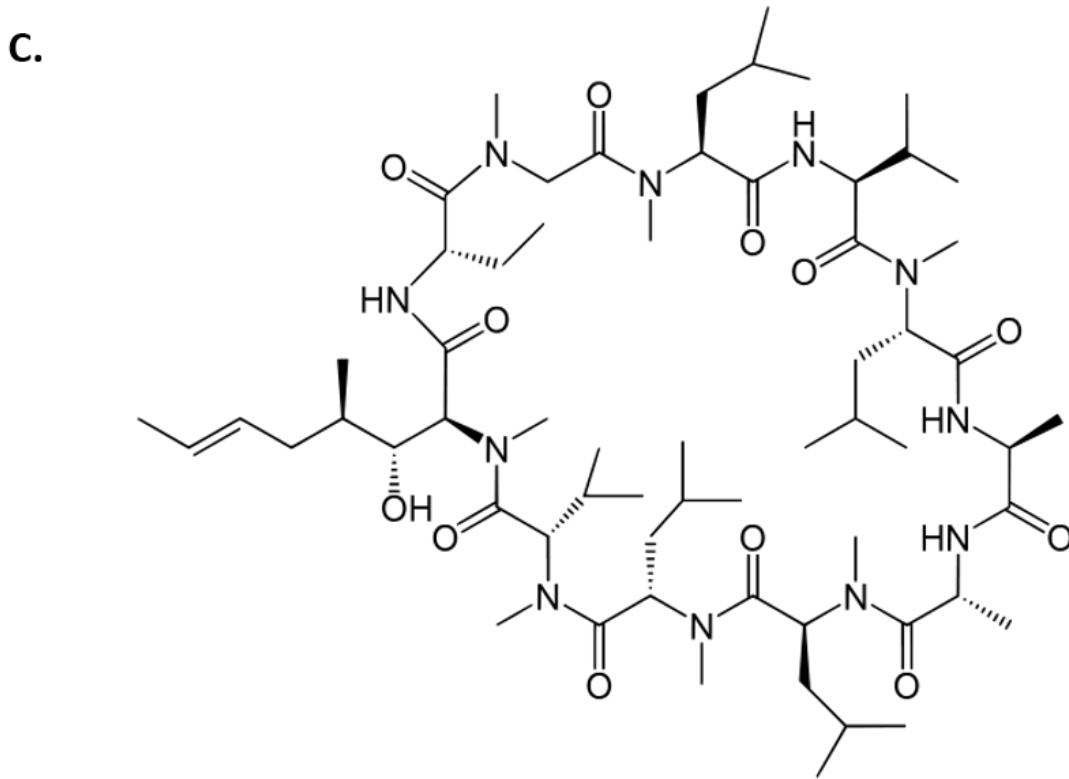

Cyclosporin Structure from [Yikrazuul](#)

Figure 6.43 Fungal Production of Cyclosporin. (A) Multicellular life-stage of the fungus, known as *Cordyceps subsessilis*, (B) unicellular life-stage of the fungus, known as *Tolyocladium inflatum*. (C) Structure of cyclosporine.

Clinically useful examples include the anticancer agents [paclitaxel](#) and [vinblastine](#) (from [Taxus brevifolia](#) and [Catharanthus roseus](#), respectively), the antimalarial agent [artemisinin](#) (from [Artemisia annua](#)), the opioid analgesic drug [morphine](#) (from [Papaver somniferum](#)), and [galantamine](#) (from [Galanthus](#) spp.), used to treat [Alzheimer's disease](#) (Fig 6.44).



Taxus brevifolia

(Photo by: [Jason Hollinger](#))

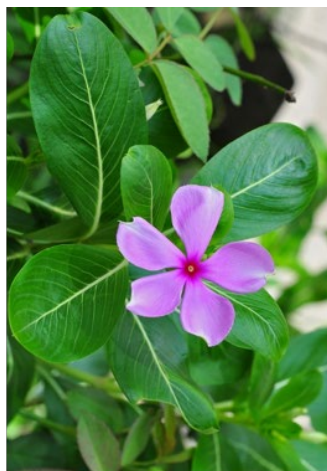
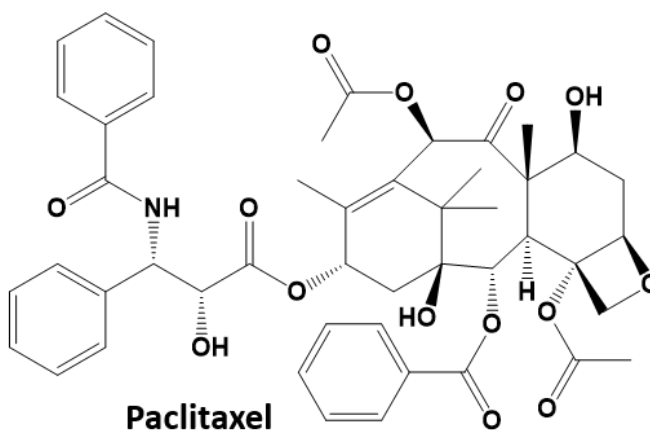

Catharanthus roseus

(Photo by: [Joydeep](#))

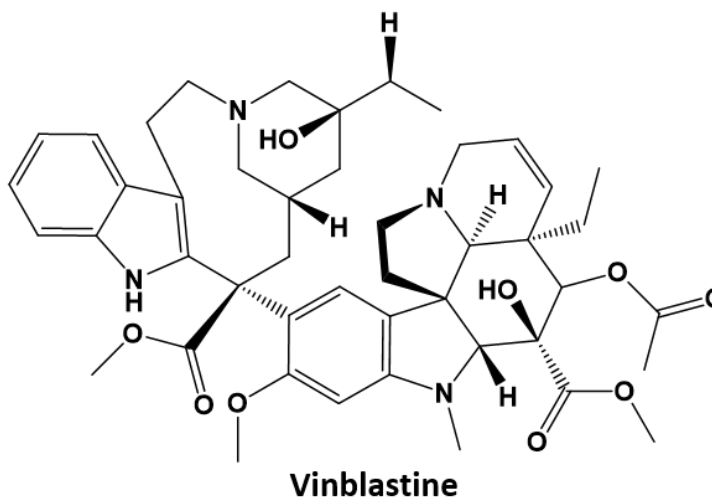



Artemisia annua

(Photo by: [Kristian Peters](#))

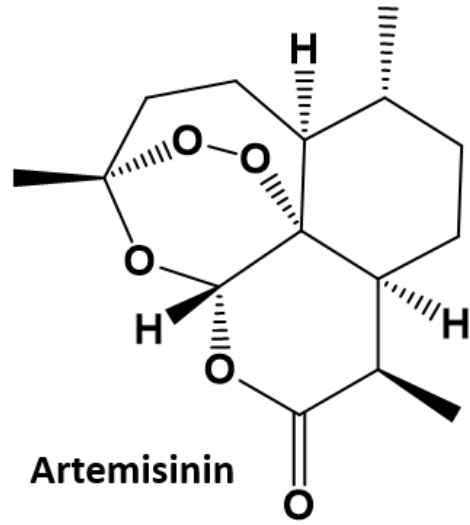

Papaver somniferum

(Photo by: [Dinkum](#))

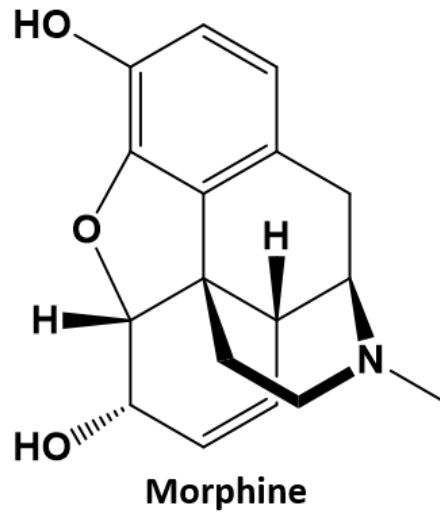



Galanthus woronowii

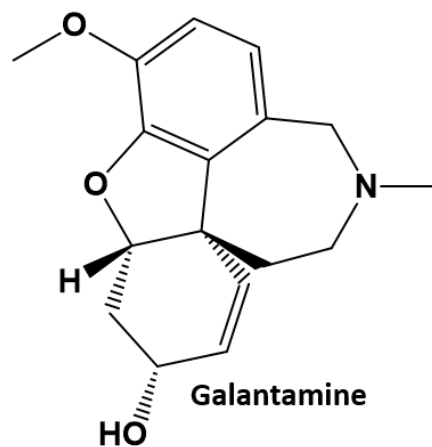

(Photo by: [Meneerke Bloem and Peter Coxhead](#))

Figure 6.44. Examples of biologically active metabolites from plants.

A Closer Look

Artemisinin, also known as *qinghao su* (Chinese: 青蒿素), possess the most rapid action of all current drugs against *Plasmodium falciparum* malaria. It was discovered by Tu Youyou, a Chinese scientist, who was awarded half of the 2015 Nobel Prize in Medicine for her discovery.

Treatments containing an artemisinin derivative (artemisinin-combinationtherapies, ACTs) are now standard treatment worldwide for *P. falciparum* malaria.

Artemisinin is isolated from the plant *Artemisia annua*, sweet wormwood, an herb employed in Chinese traditional medicine. Tu is the first Chinese Nobel laureate in physiology or medicine and the first female citizen of the People's Republic of China to receive a Nobel Prize in any category.

Tu carried on her work in the 1960s and 70s during China's Cultural Revolution, when scientists were denigrated as one of the nine black categories in society according to Maoist theory (or possibly that of the Gang of Four).

In 1967, during the Vietnam War, Ho Chi Minh, the leader of North Vietnam, which was at war against South Vietnam and the United States, asked Chinese Premier Zhou Enlai for help in developing a malaria treatment for his soldiers trooping down the Ho Chi Minh trail, where a majority came down with a form of malaria which is resistant to chloroquine. Because malaria was also a major cause of death in China's southern provinces including Hainan, Yunnan, Guangxi, and Guangdong, Zhou Enlai convinced Mao Zedong to set up a secret drug discovery project, named Project 523 after its starting date, 23 May 1967. Upon joining the project unit, Tu was initially sent to Hainan where she studied patients who had been infected with the disease.



Photo By Bengt Nyman - Own work, CC BY-SA 4.0, <https://commons.wikimedia.org/w/index.php?curid=45490780>

A Closer Look

Scientists worldwide had screened over 240,000 compounds without success. In 1969, Tu, then 39 years old, had an idea of screening Chinese herbs. She first investigated the Chinese medical classics in history, visiting practitioners of traditional Chinese medicine all over the country on her own. She gathered her findings in a notebook called *A Collection of Single Practical Prescriptions for Anti-Malaria*. Her notebook summarized 640 prescriptions. Her team also screened over 2,000 traditional Chinese recipes and made 380 herbal extracts, which were tested on mice.

One compound was effective, sweet wormwood (*Artemisia annua*), which was used for "intermittent fevers," a hallmark of malaria. As Tu also presented at the project seminar, its preparation was described in a 1,600-year-old text, in a recipe titled, "Emergency Prescriptions Kept Up One's Sleeve". At first, it didn't work, because they extracted it with traditional boiling water. Tu Youyou discovered that a low-temperature extraction process could be used to isolate an effective antimalarial substance from the plant; Tu says she was influenced by a traditional Chinese herbal medicine source, *The Handbook of Prescriptions for Emergency Treatments*, written in 340 by Ge Hong, which states that this herb should be steeped in cold water. This book contained the useful reference to the herb: "A handful of qinghao immersed with two litres of water, wring out the juice and drink it all." After rereading the recipe, Tu realised the hot water had already damaged the active ingredient in the plant; therefore she proposed a method using low-temperature ether to extract the effective compound instead. The animal tests showed it was completely effective in mice and monkeys.

Furthermore, Tu volunteered to be the first human subject. "As head of this research group, I had the responsibility" she said. It was safe, so she conducted successful clinical trials with human patients. Her work was published anonymously in 1977. In 1981, she presented the findings relating to artemisinin at a meeting with the World Health Organization.

Source: Tu Youyou. (2017, January 20). In *Wikipedia, The Free Encyclopedia*. Retrieved 03:11, February 6, 2017, from https://en.wikipedia.org/w/index.php?title=Tu_Youyou&oldid=760982918

Animals

Animals are multicellular, eukaryotic organisms of the kingdom Animalia. As described earlier, animals are heterotrophic organisms and are characterized by being mobile at some point in their lifetime. Animals can be divided broadly into vertebrates and invertebrates. Vertebrates have a backbone or spine (vertebral column), and amount to less than five percent of all described animal species. They include fish, amphibians, reptiles, birds and mammals. The remaining animals are the invertebrates, which lack a backbone. These include molluscs (clams, oysters, octopuses, squid, snails); arthropods (millipedes, centipedes, insects, spiders, scorpions, crabs, lobsters, shrimp); annelids (earthworms, leeches), nematodes (filarial worms, hookworms), flatworms (tapeworms, liver flukes), cnidarians (jellyfish, sea anemones, corals), ctenophores (comb jellies), and sponges. The study of animals is called zoology.

Animals also represent a source of bioactive natural products. In particular, venomous animals such as snakes, spiders, scorpions, caterpillars, bees, wasps, centipedes, ants, toads, and frogs have attracted much attention. This is because venom constituents (peptides, enzymes, nucleotides, lipids, biogenic amines etc.) often have very specific interactions with a macromolecular target in the body. As with plant feeding deterrents, this biological activity is attributed to natural selection, organisms capable of killing or paralyzing their prey and/or defending themselves against predators being more likely to survive and reproduce.



Chlorotoxin

Figure 6.45 Chlorotoxin from the deathstalker scorpion (*Leiurus quinquestriatus*). A ribbon diagram of the chlorotoxin protein is shown on the right. Photo of the deathstalker scorpion by: [Ester Inbar](#) and Ribbon diagram of chlorotoxin by: [Lijealso](#).

For example, [Chlorotoxin](#) is a 36-amino acid peptide found in the venom of the deathstalker scorpion ([Leiurus quinquestriatus](#)) which blocks small-conductance chloride channels (Fig. 6.45). It uses this toxin to immobilize its prey.

Remarkably, in humans chlorotoxin binds preferentially to glioma brain cancer cells. A **glioma** is a type of tumor that forms in the brain or spinal cord. It can often become **malignant**, which is a term used to describe cancer that has poor prognosis and is prone to spreading to different areas of the body. Remarkably, chlorotoxin only binds with the tumor cells and not with normal brain tissue. This feature has allowed the development of new methods to treat, diagnosis, and remove several different types of cancer. For example, TM-601 which is the synthetic version of chlorotoxin is currently under phase II clinical trial. Radioactive Iodine-131 can be attached to TM-601 and used to treat malignant glioma. TM-601 crosses blood-brain and tissue barriers and binds to the malignant brain tumor cells without affecting healthy tissue. When TM-601 is attached to the radioactive Iodine-131 the iodine will also be recruited specifically to the tumor where it can preferentially kill the tumor cells.

In addition, researchers at [Fred Hutchinson Cancer Research Center](#) have also created a chlorotoxin derivative called BLZ-100 that is attached to a fluorescent dye. This provides a long lasting signal that makes the tumor glow, almost as if all the parts of the tumor have been painted. It can be used in real time to help a surgeon determine where the edges of the tumor are or where the tumor has spread, so that it can be removed completely. Animal trials with this 'tumor paint' have shown positive results with many types of cancer. Figure 6.46 shows a tumor that has been removed from a dog that has breast cancer — it's called mammary carcinoma in a dog — and the surgeons knew about that big spot down in the bottom right, that was cancer, but really that's all they were able to tell from the clinical exam and the scans that were done in advance. This dog received a dose of tumor paint the day before surgery, and in the right panel of Figure 6.46 is what the surgeons were able to see. Not only could they see the main tumor, but they could see additional areas of cancer that were not visible to the naked eye.

All across America everyday, women who have had breast cancer surgery are told, "you have clean margins, everything looks good, we'll follow it with some scans", and then six to nine months later they start to get some bad news. Unfortunately, the surgeons can't always see exactly where the cancer is, and sometimes cancer isn't contiguous. It jumps around into some spots a little ways away from the primary, and tumor paint is helping making cancer much more visible. To hear more about this and other related drug developments, listen to [Jim Olson's Geekwire Talk](#).

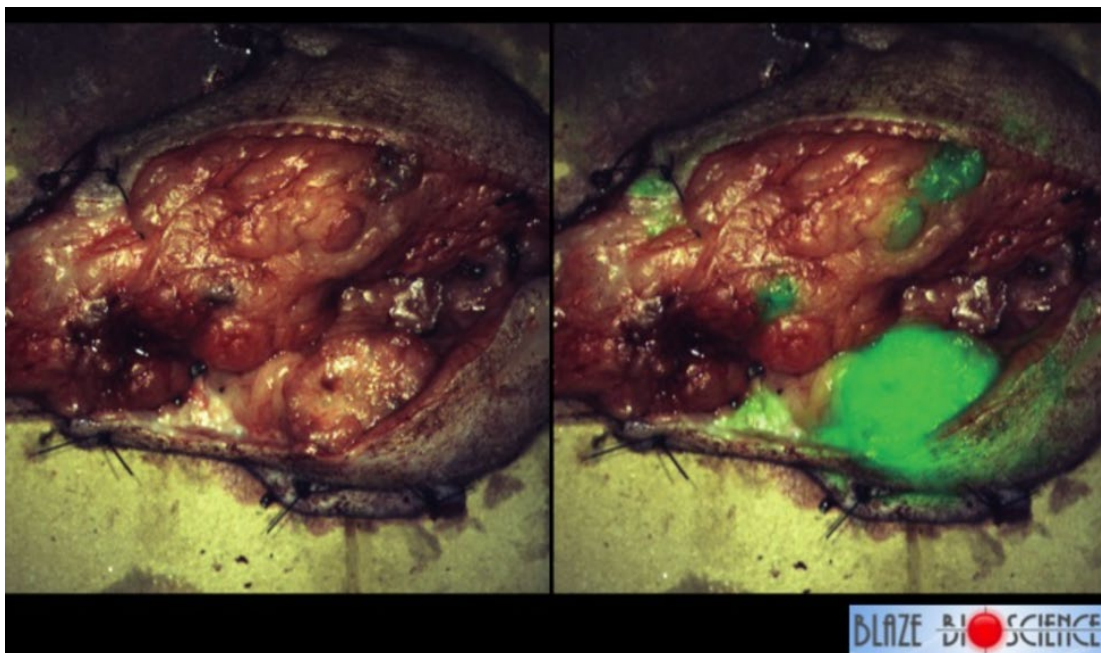

Figure 6.46 Making Cancer Visible. On the left is a photo of a mammary tumor that has been removed from dog. On the right, is the same mammary tumor exposed to BLZ-100. The fluorescent areas are where the cancer tissue is present. Photo by [Todd Bishop at Geekwire](#).

Other novel drugs that have arisen from animal venoms include, teprotide, a peptide isolated from the venom of the Brazilian pit viper **Bothrops jararaca** (Fig 6.47). Teprotide was found to have activity as an antihypertensive agent and provided an initial lead compound for the development of blood pressure lowering medications. It was not a good drug candidate on its own, due to the expense in isolating it and the lack of oral availability. However the structure was used as a lead compound and many derivative structures were made to try and find smaller, more soluble, orally active compounds that had the same biological activity. This has resulted in the development of the currently prescribed antihypertensive agents, cilazapril and captopril (Fig 6.47).

A.



B.

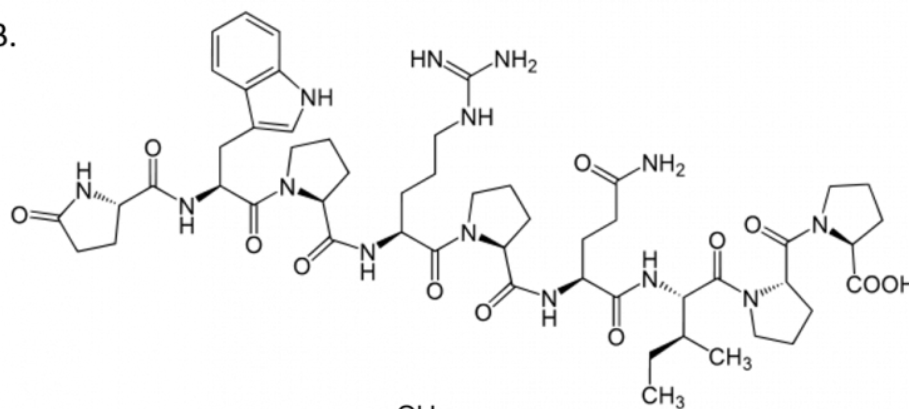

C.

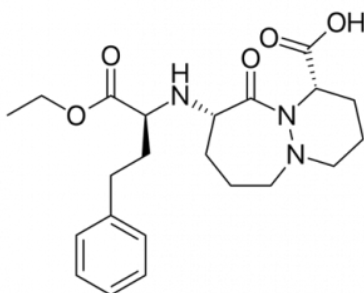

D.

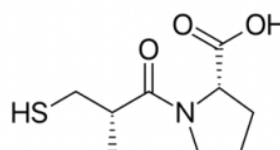

6.47 Teprotide and Its Synthetic Derivatives Cilazapril and Captopril. Teprotide (B) is a toxin produced by the pit viper, *Bothrops jararaca* (A). Due to poor oral availability and expense teprotide was not a good drug compound, however, its biological activity lead to the development of the synthetic antihypertensive drugs, Cilazapril (C) and Captopril (D).

Photo of **Bothrops jararaca** by: [Felipe Sösekind](#), Structure of Teprotide by: [Yikrazuul](#), Structure of Cilazapril by: [Vaccinationist](#), and Structure of Captopril by: [Vaccinationist](#).

In addition to the terrestrial animals described above, many marine animals have been examined for pharmacologically active natural products, with [corals](#), [sponges](#), [tunicates](#), [sea snails](#), and [bryozoans](#) yielding chemicals with interesting analgesic, antiviral, and anticancer activities. Two examples developed for clinical use include [\$\omega\$ -conotoxin](#) (from the marine snail [Conus magus](#)) and ecteinascidin 743 (from the tunicate [Ecteinascidia turbinata](#)) (Figure 6.48). The former, ω -conotoxin, is used to relieve severe and chronic pain, while the latter, ecteinascidin 743 is used to treat cancer.

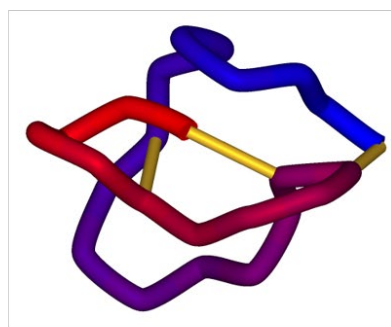

ω -conotoxin

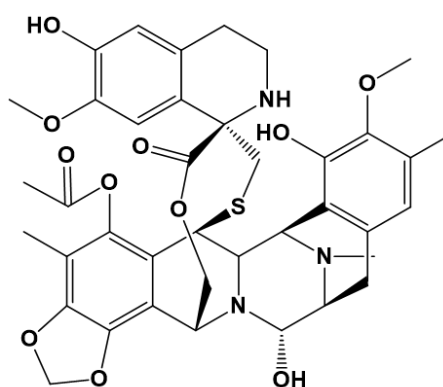

ET-743

6.48 Medicines from the Sea. In the upper panel the marine snail, **Conus magus** and its active metabolite, ω -conotoxin, are shown. Note that ω -conotoxin is a protein. Thus, its structure is much too large to show all the organic bonds. Proteins are often depicted in ribbon diagrams to give you a sense of the 3-dimensional folding patterns. In the lower panel the tunicate **Ecteinascidia turbinata** and its metabolite, ecteinascidin 743 (ET-743) are shown. Photo of *Conus magus* provided by: [Richard Parker](#). Ribbon diagram of ω -conotoxin provided by: [Fvasconcellos](#). Photo of the tunicate, *Ecteinascidia turbinata* provided by: [Sean Nash](#).

Section 6.9: Chapter Summary

Interest in the biological activities of natural products from different organisms, especially for the discovery of useful medicines, has been a major driving force for the development of organic chemistry concepts and laboratory techniques.

Natural products can be divided into two major classes, **primary metabolites**, which are required for an organism to survive, and **secondary metabolites**, which are not required for an organism to survive, but usually lend the organism some form of growth or survival advantage within its environment.

Natural products are often classified based on major structural features. Four of the major classes of natural products are the **alkaloids**, which are organic molecules that contain nitrogen, the **phenylpropanoids** which are derived from the amino acids phenylalanine or tyrosine, the polyketides derived from acetate and malonate, and the terpenoids, derived from the five-carbon building block, isoprene.

The process of searching for and finding new natural products throughout the world is called bioprospecting and the discipline that elucidates the structure of natural products and studies their biological activity is called pharmacognosy.

Biologically-active natural products can be found in all forms of life on the planet. The natural world is divided up into two major types of organisms: Prokaryotic organisms that are unicellular and lack membrane-bound organelles, and Eukaryotic organisms that can be unicellular or multicellular and have a nucleus and other membrane-bound organelles. Biologists classify Prokaryotic organisms into two major life domains, Bacteria and Archaea. The third domain, Eukaryota, houses all eukaryotic organisms. The domain Eukaryota is sub-divided into four major kingdoms, Animalia, Plantae, Fungi, and Protista. Some scientists breakdown the Kingdom Protista into smaller sub-categories. Natural products discovery from organisms within all of life's major domains have made lasting contributions to Western Medicine.

Early investigations into organic chemistry and structure elucidation included work by Michel Chevreul on the study of soaps. The process of making soaps from fats and alkalis (basic substances) is called saponification. In the saponification reaction, an alkali base, such as sodium hydroxide, is used to breakdown an ester bond into an alcohol and the salt of a carboxylic acid (in this case, the fatty acid). These early studies, and studies by Wohler and others, paved the way for the field of **Synthetic Organic Chemistry**, the study of making organic molecules.

Section 6.10: References

Chapter 6 materials have been adapted and modified from the following creative commons resources unless otherwise noted:

1. Natural product. (2016, December 29). In *Wikipedia, The Free Encyclopedia*. Retrieved 06:30, January 27, 2017, from https://en.wikipedia.org/w/index.php?title=Natural_product&oldid=757173982
2. Ergotism. (2016, December 24). In *Wikipedia, The Free Encyclopedia*. Retrieved 07:36, February 3, 2017, from <https://en.wikipedia.org/w/index.php?title=Ergotism&oldid=756409773>
3. Prokaryote. (2016, December 30). In *Wikipedia, The Free Encyclopedia*. Retrieved 20:33, January 27, 2017, from <https://en.wikipedia.org/w/index.php?title=Prokaryote&oldid=757396179>
4. Wikibooks. (2015) Organic Chemistry. Available at: https://en.wikibooks.org/wiki/Organic_Chemistry.
5. Clark, J. (2014) How to Draw Organic Molecules. Available at: [http://chem.libretexts.org/Core/Organic_Chemistry/Fundamentals/How to Draw Organic Molecules](http://chem.libretexts.org/Core/Organic_Chemistry/Fundamentals/How_to_Draw_Organic_Molecules)
6. Soderberg, T. (2016). [Organic Chemistry With a Biological Emphasis](#) . Published under Creative Commons by-nc-sa 3.0.
7. Anonymous. (2012) Introduction to Chemistry: General, Organic, and Biological (V1.0). Published under Creative Commons by-nc-sa 3.0. Available at: <http://2012books.lardbucket.org/books/introduction-to-chemistry-general-organic-and-biological/index.html>
8. Pyrococcus furiosus. Available at: https://en.wikipedia.org/wiki/Pyrococcus_furiosus
9. Li, B., Wang, Z., Li, S., Donelan, W., Wang, X., Cui, T., & Tang, D. (2013). Preparation of lactose-free pasteurized milk with a recombinant thermostable β -glucosidase from *Pyrococcus furiosus*. *BMC Biotechnology*, 13, 73. <http://doi.org/10.1186/1472-6750-13-73>

10. Animal. (2017, February 5). In *Wikipedia, The Free Encyclopedia*. Retrieved 03:53, February 6, 2017, from <https://en.wikipedia.org/w/index.php?title=Animal&oldid=763775373>
11. Organic chemistry. (2017, February 8). In *Wikipedia, The Free Encyclopedia*. Retrieved 06:18, February 9, 2017, from https://en.wikipedia.org/w/index.php?title=Organic_chemistry&oldid=764307722
12. OpenStax, Biology. OpenStax CNX. May 27, 2016 <http://cnx.org/contents/s8Hh0oOc@9.10:QhGQhr4x@6/Biological-Molecules>
13. Molnar, C. and Gair, J. (2012) [2.3 Biological Molecules](#) Chapter in Concepts in Biology, OpenStax College Textbooks, British Columbia. Retrieved on Dec 22nd, 2018 from: <https://opentextbc.ca/biology/chapter/2-3-biological-molecules/>
14. Ophardt, C. (2015) Carbohydrates. In **Biological Chemistry**. Libretexts. Available at: https://chem.libretexts.org/Core/Biological_Chemistry
15. Gunawardena, G. (2014) Haworth Projections. In **Biological Chemistry**. Libretexts. Available at: https://chem.libretexts.org/Core/Biological_Chemistry.
16. Snell, Foster D. "Soap and glycerol." *J. Chem. Educ.* 1942, 19, 172.
17. OpenStax, Proteins. OpenStax CNX. Sep 30, 2016 <http://cnx.org/contents/bf17f4df-605c-4388-88c2-25b0f000b0ed@2>.
18. OpenStax, Microbiology. Libretexts. Dec 14, 2015 Available at: [https://bio.libretexts.org/TextMaps/Map%3AMicrobiology_\(OpenStax\)](https://bio.libretexts.org/TextMaps/Map%3AMicrobiology_(OpenStax))
19. Ed Vitz (Kutztown University), [John W. Moore](#) (UW-Madison), [Justin Shorb](#) (Hope College), [Xavier Prat-Resina](#) (University of Minnesota Rochester), Tim Wendorff, and Adam Hahn. (2016) Exemplars and Case Studies. Libretexts. Available at: https://chem.libretexts.org/Exemplars_and_Case_Studies/Exemplars/Culture/Secondary_Protein_Structure_in_Silk

Chapter 7: Chemical Reactions in Biological Systems

Section 7.1: What is Metabolism?

Metabolism is the set of life-sustaining chemical reactions in organisms. We have seen examples of metabolic processes in the primary and secondary metabolites covered in Chapter 6. Overall, the three main purposes of metabolism are: (1) the conversion of food to energy to run cellular processes; (2) the conversion of food/fuel to building blocks for proteins, lipids, nucleic acids, and carbohydrates; and (3) the elimination of waste products. These enzyme-catalyzed reactions allow organisms to grow and reproduce, maintain their structures, and respond to their environments. (The word metabolism can also refer to the sum of all chemical reactions that occur in living organisms, including digestion and the transport of substances into and between different cells, in which case the above described set of reactions within the cells is called intermediate metabolism.)

Metabolic reactions may be categorized as **catabolic** - the *breaking down* of compounds (for example, the breaking down of proteins into amino acids during digestion); or **anabolic** - the *building up* (synthesis) of compounds (such as proteins, carbohydrates, lipids, and nucleic acids). Usually, catabolism releases energy, and anabolism consumes energy.

The chemical reactions of metabolism are organized into metabolic pathways, in which one chemical is transformed through a series of steps into another chemical, each step being facilitated by a specific enzyme. Enzymes are crucial to metabolism because enzymes act as catalysts - they allow a reaction to proceed more rapidly. In addition, enzymes can provide a mechanism for cells to regulate the rate of a metabolic reaction in response to changes in the cell's environment or to signals from other cells, through the activation or inhibition of the enzymes activity. Enzymes can also allow organisms to drive desirable reactions that require energy that will not occur by themselves, by coupling them to spontaneous reactions that release energy. Enzyme shape is critical to the function of the enzyme as it determines the specific binding of a reactant. This can occur by a **lock and key model** where the reactant is the exact shape of the enzyme binding site, or by an **induced fit model**, where the contact of the reactant with the protein causes the shape of the protein to change in order to bind to the reactant.

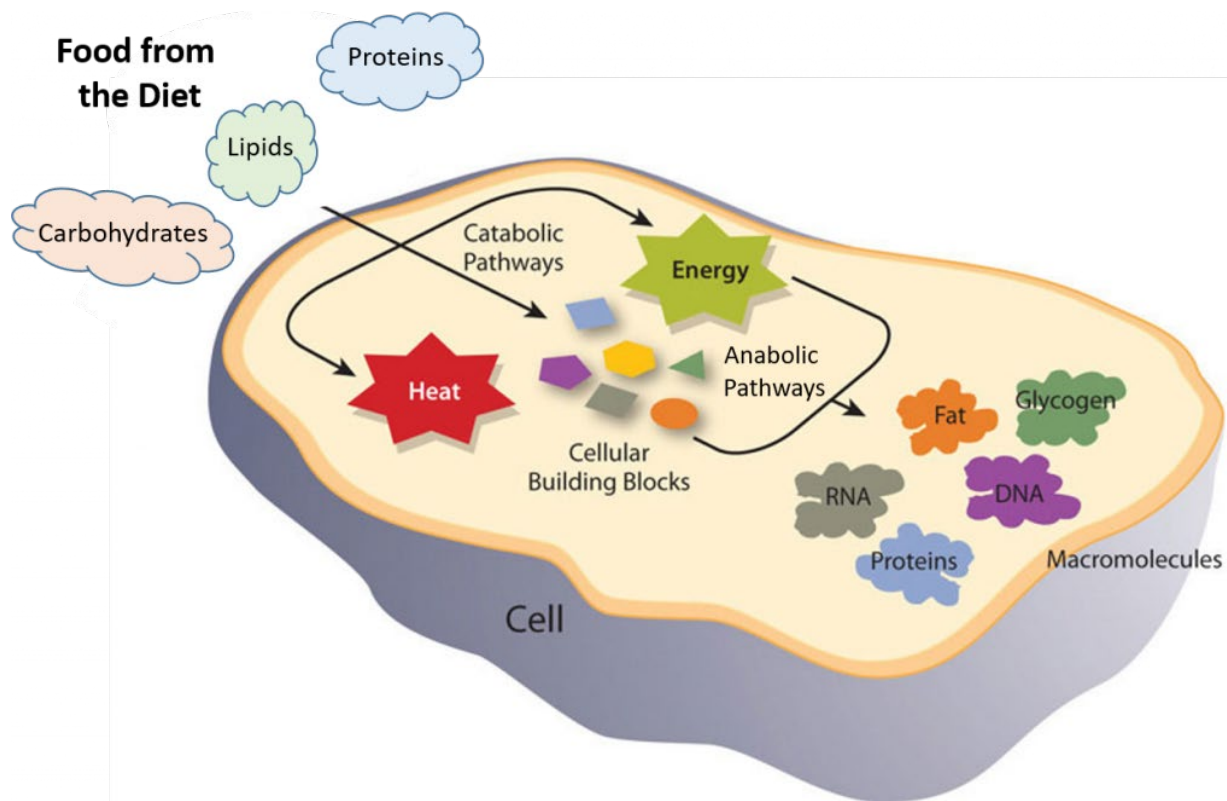

Figure 7.1 Catabolic and Anabolic Reactions. Catabolic reactions involve the breakdown of molecules into smaller components, whereas anabolic reactions build larger molecules from smaller molecules. Catabolic reactions usually release energy whereas anabolic processes usually require energy.

Figure is modified from [Metabolism Overview](#)

Section 7.2: Common Types of Biological Reactions

Within biological systems there are six major classes of biochemical reactions that are mediated by enzymes. These include group transfer reactions, the formation/removal of carbon-carbon double bonds, isomerization reactions, ligation reactions, hydrolysis reactions, and oxidation-reduction reactions. This section will give you a brief introduction to these six types of reactions and then the following section will focus more in-depth on oxidation-reductions and how they are critical for the formation of the major form of cellular energy, adenosine triphosphate (ATP). Note that all of these reaction types require an enzyme catalyst (usually a specific protein) to speed up the rate of the reactions within biological systems.

A.

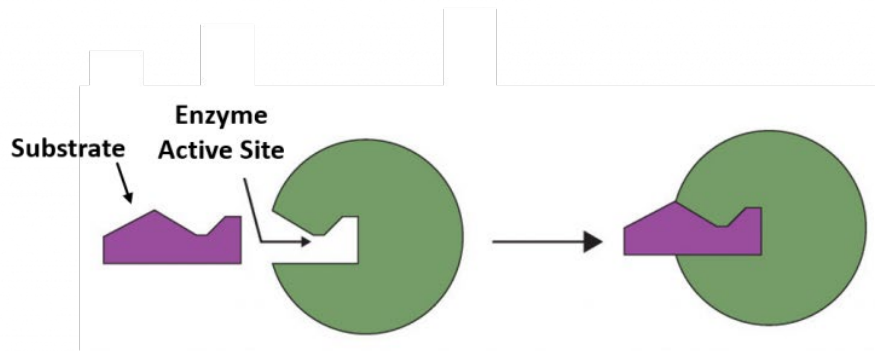

B.

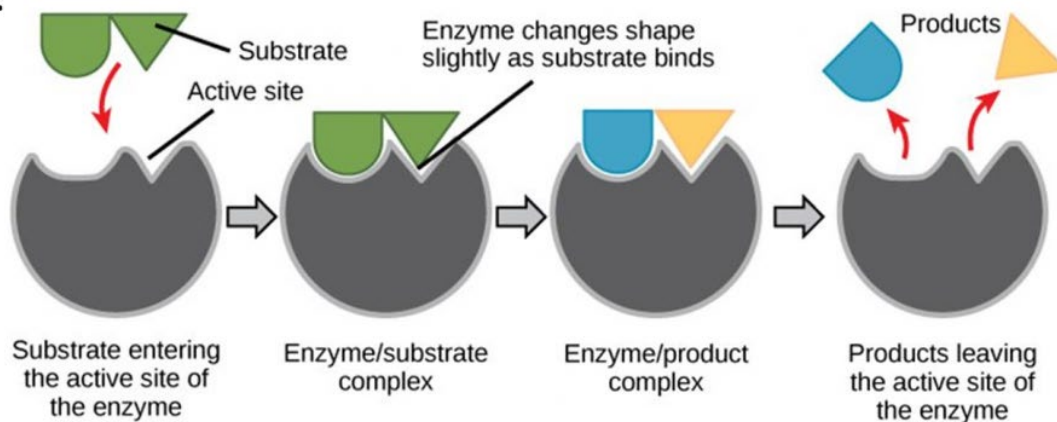

Figure 7.2 Mechanisms of Enzyme-Substrate Binding. (A) In the Lock and Key Model, substrates fit into the active site of the enzyme with no further modifications to the enzyme shape required. (B) In the Induced Fit Model, substrate interaction with the enzyme causes the shape of the enzyme to change to better fit the substrate and mediate the chemical reaction.

Figure 7.2A was modified from [Socratic](#) and Figure 7.2B was modified from [Concepts in Biology](#)

Group Transfer Reactions

In **group transfer reactions**, a functional group will be transferred from one molecule that serves as the donor molecule to another molecule that will be the acceptor molecule. The transfer of an amine functional group from one molecule to another is common example of this type of reaction and is shown in Figure 7.3.

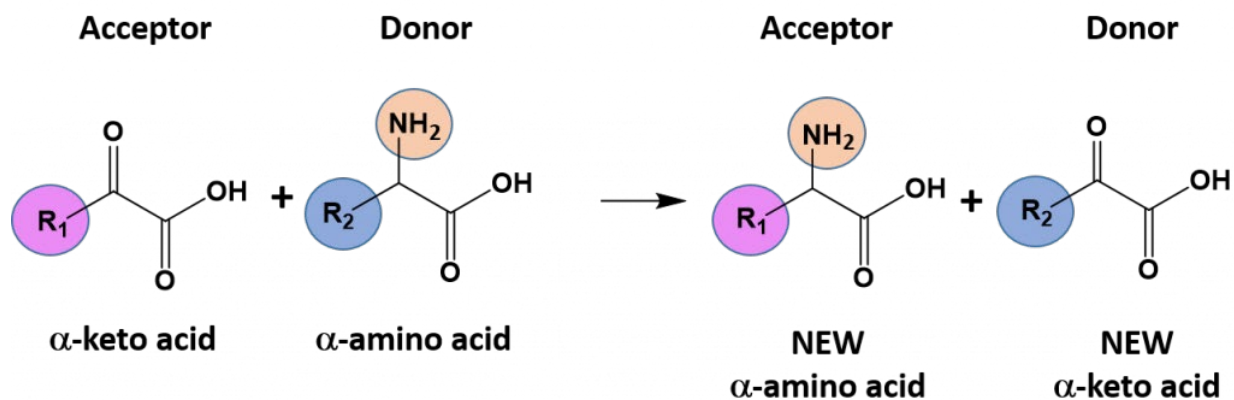

Figure 7.3 Transfer of an Amine Functional Group. A common group transfer reaction in biological systems is one that is used to produce α -amino acids that can then be used for protein synthesis. In this reaction, one α -amino acid serves as the donor molecule and an α -keto acid (these molecules contain a carboxylic acid functional group and a ketone functional group separated by one α -carbon) serves as the acceptor. In the acceptor molecule, the carbonyl oxygen is replaced with the amine functional group, whereas in the donor molecule, the amine functional group is replaced by an oxygen forming a new ketone functional group.

The Formation/Removal of Carbon-Carbon Double Bonds

Reactions that mediate the formation and removal of carbon-carbon double bonds are also common in biological systems and are catalyzed by a class of enzymes called **lyases**. The formation or removal of carbon-carbon double bonds is also used in synthetic organic chemistry reactions to create desired organic molecules. One of these types of reactions is called a **hydrogenation reaction**, where a molecule of hydrogen (H_2) is added across a C-C double bond, reducing it to a C-C single bond. If this is done using unsaturated oils, the unsaturated fats can be converted into saturated fats (Figure 7.4). This type of reaction is commonly done to produce partially hydrogenated oils converting them from liquids at room temperature into solids. Margarines made from vegetable oil are made in this manner. Unfortunately, a by-product of this reaction can be the formation of TAGS containing **trans** double bonds. Once the health hazards of consuming trans fats was recognized, the Food and Drug Administration (FDA) placed a ban on the inclusion of **trans** fats in food products. This ban was enacted in the summer of 2015 and gave food-makers three years to eliminate them from the food supply, with a deadline of June 18, 2018.

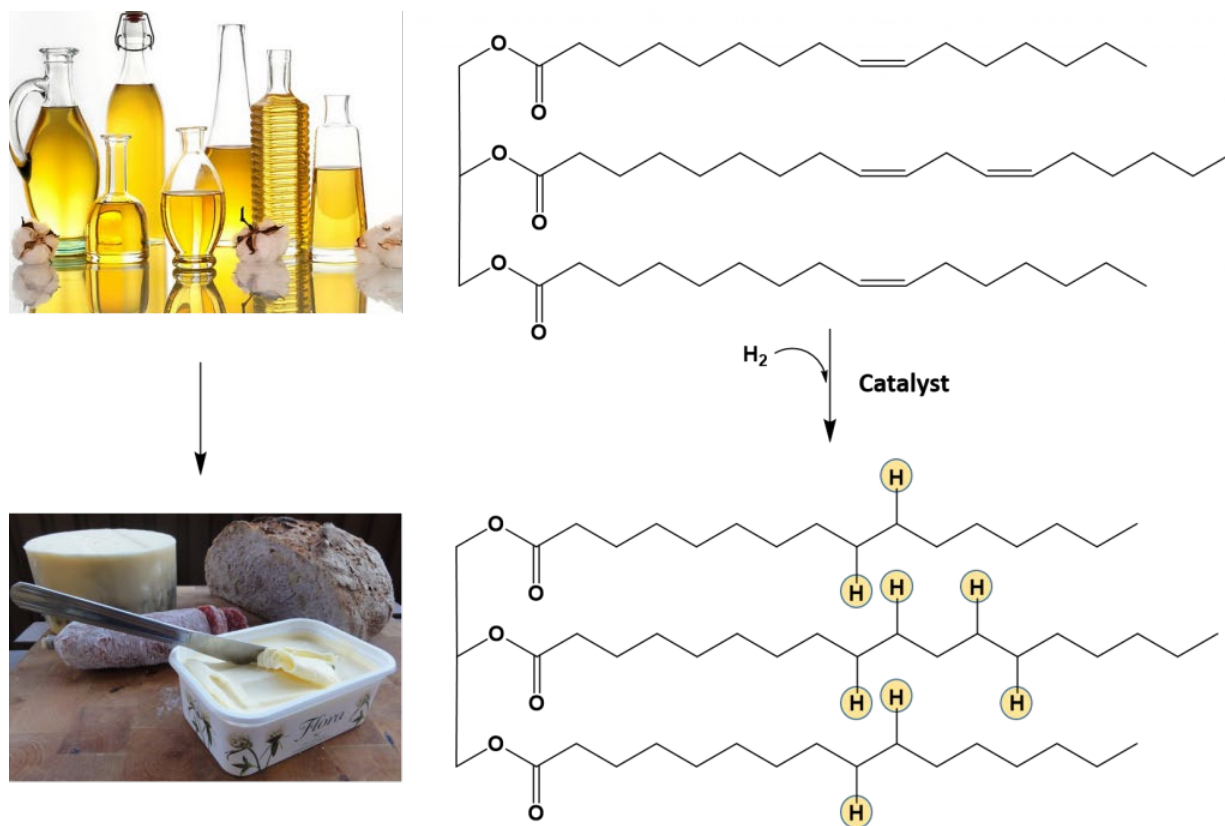

Figure 7.4 Hydrogenation of Oils to Produce Margarine. Unsaturated oils can be partially or fully hydrogenated to produce the saturated fatty acids to produce margarines that will remain solid at room temperature. The addition of the new hydrogen atoms to create the saturated hydrocarbons are shown in yellow in the final product.

Upper photo provided by [Cottonseed Oil](#) and lower photo provided by [Littlegun](#)

Isomerization Reactions

In isomerization reactions a single molecule is rearranged such that it retains the same molecular formula but now has a different bonding order of the atoms forming a structural or stereoisomer. The conversion of glucose 6-phosphate to fructose 6-phosphate is a good example of an isomerization reaction and is shown in figure 7.5

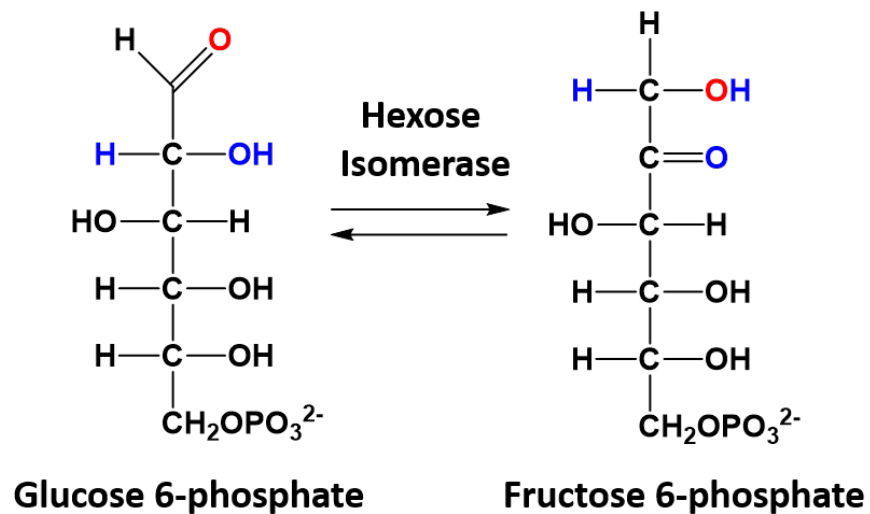

Figure 7.5 Isomerization of Glucose 6-phosphate to Fructose 6-phosphate.

Ligation Reactions

Ligation reactions use the energy of ATP to join two molecules together. An example of this kind of reaction is the joining of the amino acid with the transfer RNA (tRNA) molecule during protein synthesis. During protein synthesis the tRNA molecules bring each of the amino acids to the ribosome where they can be incorporated into the newly growing protein sequence. To do this, the tRNA molecules must first be attached to the appropriate amino acid. Specific enzymes are available called amino acyl - tRNA synthetases that mediate this reaction. The synthetase enzymes use the energy of ATP to covalently attach the amino acid to the tRNA molecule. A diagram of this process is shown in Figure 7.6. For each of the 20 amino acids, there is a specific tRNA molecule and a specific synthetase enzyme that will ensure the correct attachment of the correct amino acid with its tRNA molecule.

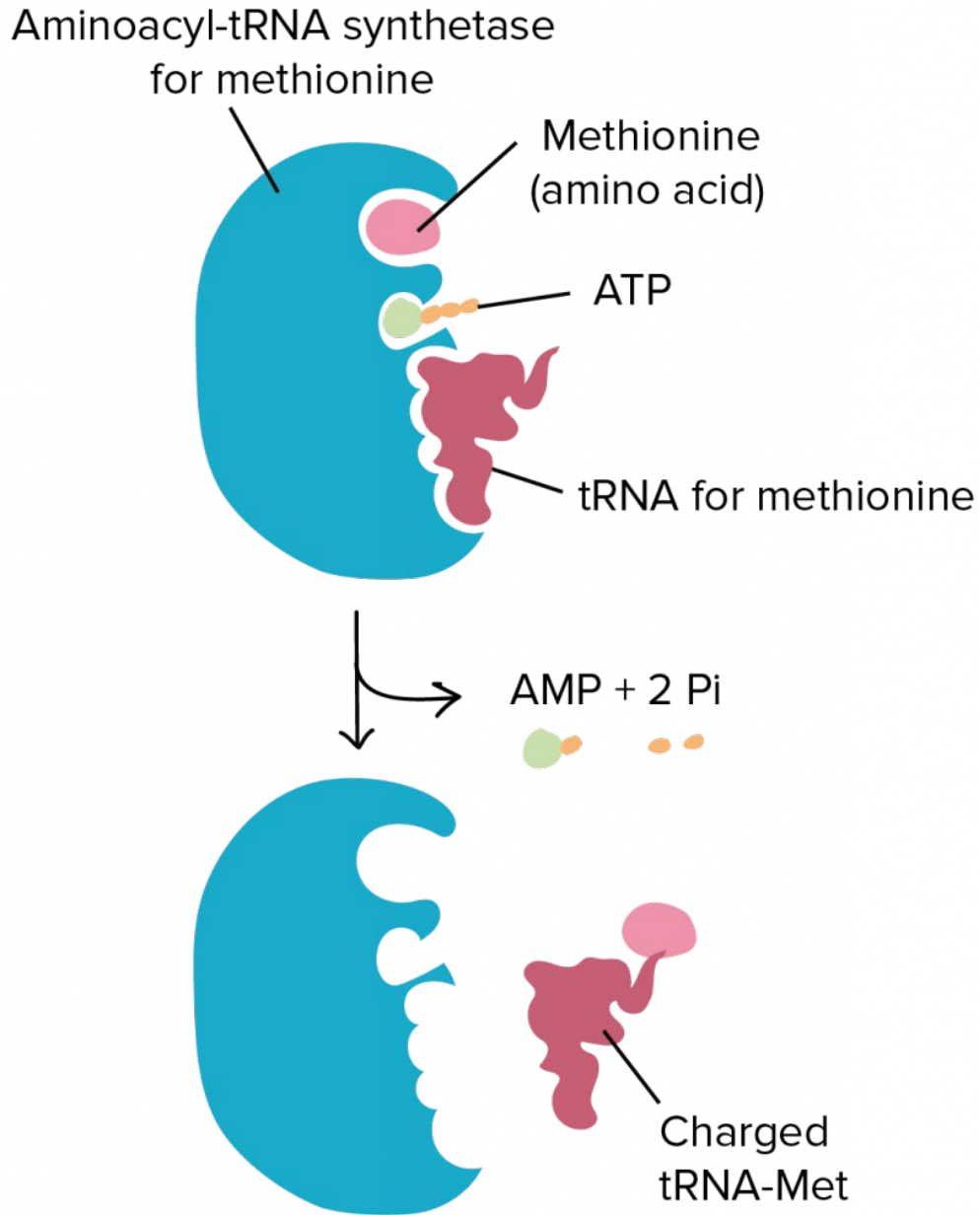

Figure 7.6 Ligation Reaction Covalently Attaching Methionine with the Appropriate tRNA. The amino-acyl tRNA synthetase enzyme for methionine (shown in blue) covalently attaches methionine (light pink) with the methionine tRNA molecule (dark pink). This reaction requires the energy provided from the breakdown of the ATP molecule into AMP, releasing energy with the breakdown of the phosphate bonds into two inorganic phosphate ions (2 Pi).

Figure provided by the [Kahn Academy](https://www.kahnacademy.com/)

Hydrolysis Reactions

The classification of hydrolysis reactions include both the forward reactions that involve the addition of water to a molecule to break it apart or the reverse reaction involving the removal of water to join molecules together, termed dehydration synthesis (or condensation) (Figure 7.7). When water is added to a molecule to break it apart into two molecules this reaction is called hydrolysis. The term 'lysis' means to break apart, and the term '**hydro**' refers to water. Thus, the term **hydrolysis** means to break apart with water. The reverse of that reaction involves the removal of water from two molecules to join them together into a larger molecule. Since the two molecules are losing water, they are being dehydrated. Thus, the formation of molecules through the removal of water is known as dehydration synthesis. Since water is also a by-product of these reactions, they are also commonly referred to as condensation reactions. As we have seen in Chapter 6, the formation of the major classes of macromolecules in the body (proteins, carbohydrates, lipids, and nucleic acids) are formed through **dehydration synthesis** where water is removed from the molecules (Figure 7.x). During normal digestion of our food molecules, the major macromolecules are broken down into their building blocks through the process of hydrolysis.

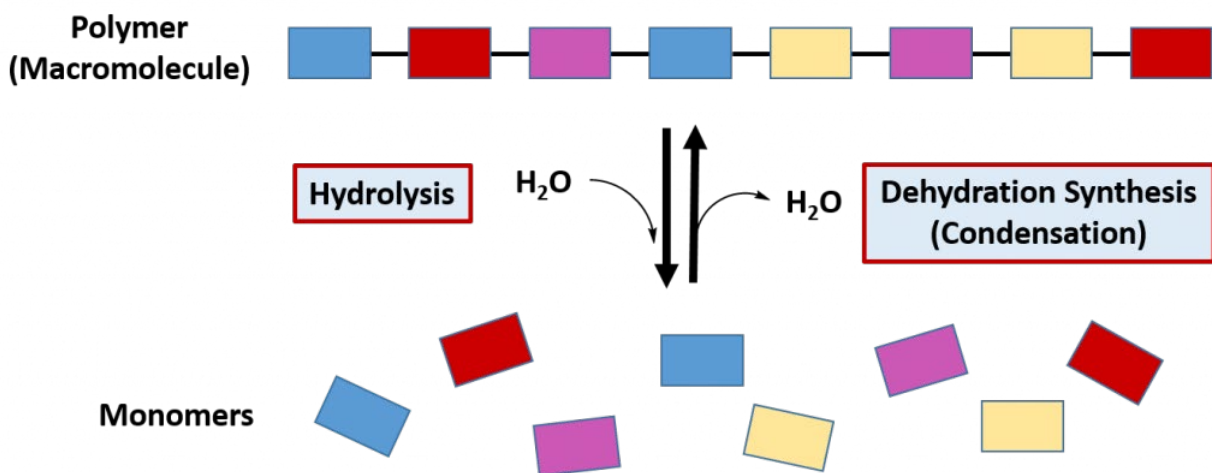

Figure 7.7 Hydrolysis and Dehydration Synthesis. The reactions of hydrolysis mediate the breakdown of larger polymers into their monomeric building blocks by the addition of water to the molecules. The reverse of the reaction is dehydration synthesis, where water is removed from the monomer building blocks to create the larger polymer structure.

As you learned in Chapter 6, the major macromolecules are built by putting together repeating monomer subunits through the process of dehydration synthesis. Interestingly, the organic functional units used in the dehydration synthesis processes for each of the major types of macromolecules have similarities with one another. Thus, it is useful to look at the reactions together (Figure 7.8)

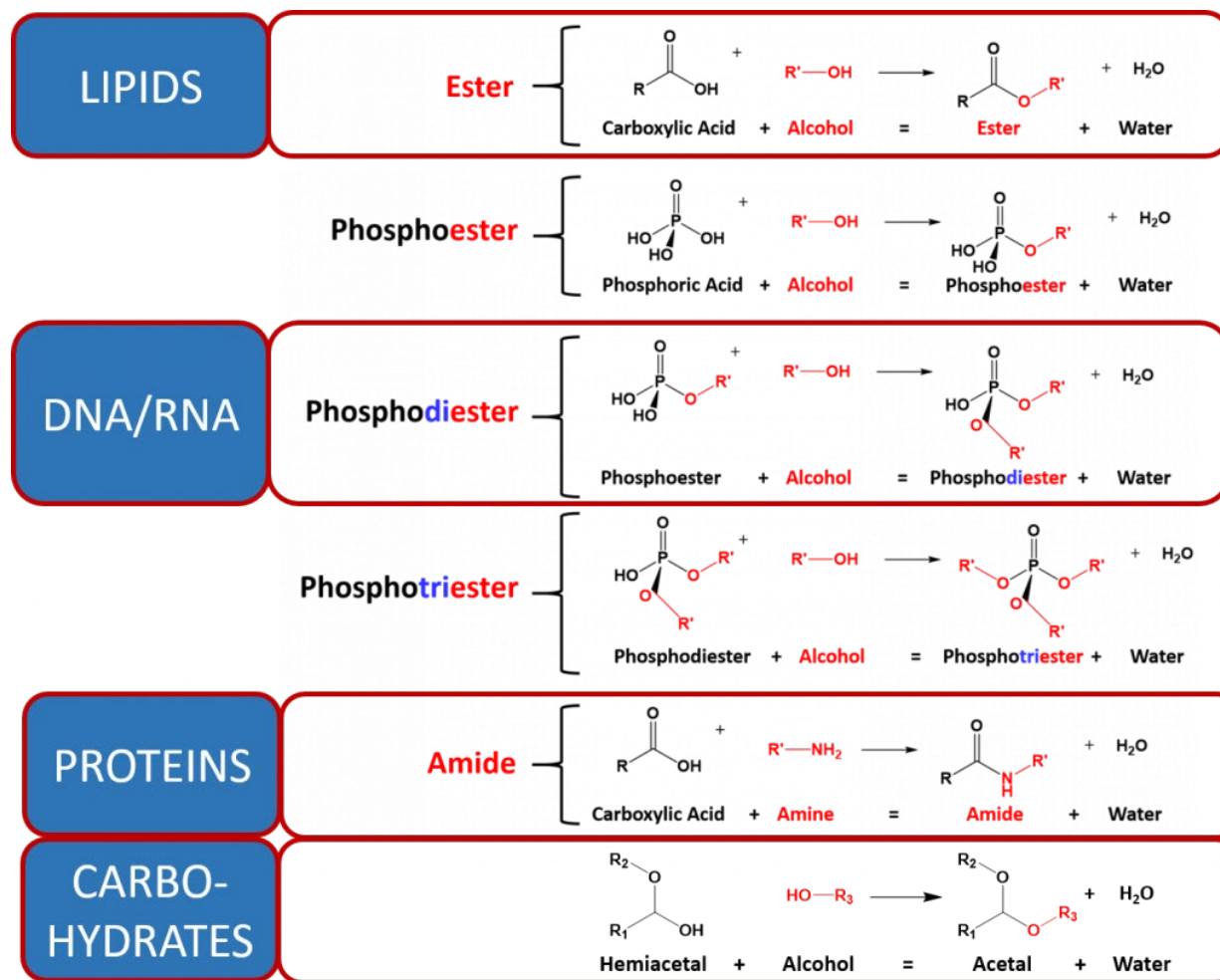

Figure 7.8 Dehydration Synthesis Reactions Involved in Macromolecule Formation.

The major organic reactions required for the biosynthesis of lipids, nucleic acids (DNA/RNA), proteins, and carbohydrates are shown. Note that in all of the reactions, there is a functional group that contains two electron withdrawing groups (the carboxylic acid, phosphoric acid and the hemiacetal each have two oxygen atoms attached to a central carbon or phosphorus atom). This forms a reactive partially positive center atom (carbon in the case of the carboxylic acid and hemiacetal, or phosphorus in the case of the phosphoric acid) that can be attacked by the electronegative oxygen or nitrogen from an alcohol or amine functional group.

The formation of esters and the related compounds, amides, phosphoesters, and acetals are formed by dehydration synthesis, involving the loss of water. The reaction mechanisms for each of these reactions is very similar. Let's take a look at the formation of the ester linkage as an example (Figure 7.9).

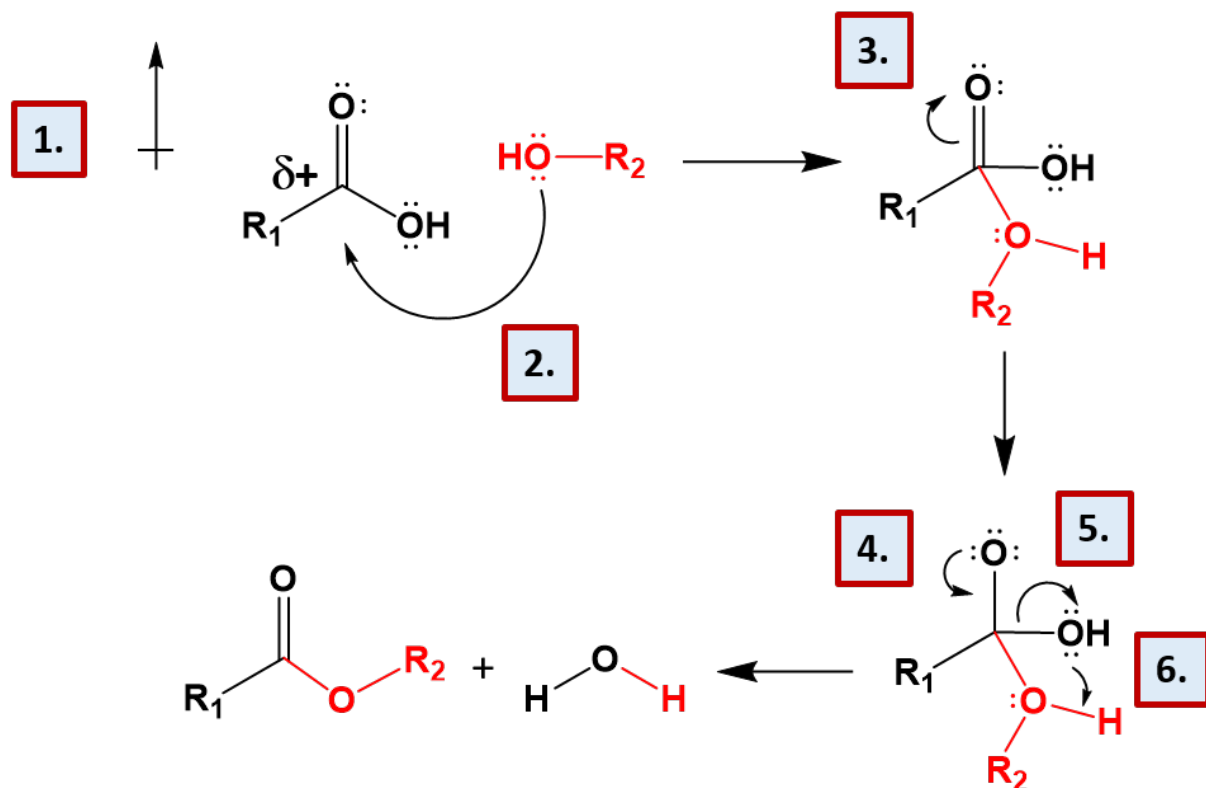

Figure 7.9 Reaction Mechanism of Ester Formation. (1) This reaction mechanism is set up by the nature of carboxylic acid functional group. The presence of the carbonyl oxygen and the alcohol functional groups create an electron withdrawing situation, where the electronegative oxygen atoms pull the electrons away from the central carbon atom. This creates a very polar situation, where the central carbon has a strong partial positive character. (2) The strong partial positive character of the central carbon atom of the carboxylic acid attracts one of the lone pair electron groups from the alcohol functional group, shown in red. This enables a new covalent bond to form between the alcohol functional group and the carboxylic acid functional group. This creates an intermediate that has five bonds attached to the central carbon and three bonds attached to the oxygen atom of the incoming alcohol. (3) The intermediate with five bonds to the central carbon is unstable and wouldn't normally form, however the presence of the carbonyl oxygen makes the reaction more favorable. It will be able to temporarily absorb the extra electron potential around the central carbon atom, due to its electronegative character and the double bond will temporarily shift up onto the central oxygen forming a lone pair

intermediate. (4) The extra lone pair on the carbonyl oxygen shifts back down to reform the double bond with the central carbon. (5) This causes the shared electron pair between the central carbon atom and the original alcohol functional group to shift over to the alcohol, breaking the covalent bond. (6) The extra lone pair of electrons on the free alcohol group take the proton from the new incoming alcohol group forming a molecule of water and the final ester structure.

All of the dehydration synthesis reactions shown for the major macromolecules have a similar reaction mechanism to that shown for the ester bond formation. Notice that the reverse of the reactions show mediate the hydrolysis of the bond linkage by the addition of the water molecule across the bond. This restores the original functional groups, a carboxylic acid and an alcohol in the case of the ester.

Oxidation-Reduction Reactions

An oxidation-reduction (redox) reaction is a type of chemical reaction that involves a transfer of electrons between two atoms or compounds. The substance that loses the electrons is said to be oxidized, while the substance that gains the electrons is said to be reduced. **Redox** reactions always have to occur together. If one molecule is oxidized, then another molecule has to be reduced (ie. electrons don't appear out of thin air to be added to a compound, they always have to come from somewhere!).

The change in electron composition can be evaluated in the change of the **oxidation state (or number)** of an atom. Therefore, an oxidation-reduction reaction is any chemical reaction in which the oxidation state (number) of a molecule, atom, or ion changes by gaining or losing an electron. We will learn how to evaluate the oxidation state of a molecule within this section. Overall, redox reactions are common and vital to some of the basic functions of life, including photosynthesis, respiration, combustion, and corrosion or rusting.

As shown in Figure 7.10, an easy mnemonic for helping you remember which member gains electrons and which member loses electrons is 'LEO the lion says GER', where **LEO** stands for **L**ose **E**lectrons = **O**xidized and **GER** stands for **G**ain **E**lectrons = **R**educed.

LEO
(Lose Electrons = Oxidized)

The Lion, Says...

GER
(Gain Electrons = Reduced)



Figure 7.10. The Rules of Oxidation and Reduction. The mnemonic LEO the lion says GER is a helpful way to remember the major concepts of Oxidation-Reduction reactions, noting that when a molecule **L**oses **E**lectrons it is **O**xidized (**LEO**), and when a molecule **G**ains **E**lectrons it is **R**educed (**GER**).

Rules for Assigning Oxidation States

The oxidation state of an element corresponds to the number of electrons, e^- , that an atom loses or gains during an ionic bond, or appears to lose/gain when joining in covalent bonds with other atoms in compounds. In determining the oxidation state of an atom, there are seven guidelines to follow:

1. The oxidation state of an atom in its elemental form is 0. (This includes elemental forms that occur as diatomic molecules. For example, each oxygen in a molecule of O_2 , has an oxidation state = 0.)
2. The total oxidation state of all atoms in a **neutral species** is 0 and in an **ion** is equal to the ion charge. (For example, the overall oxidation state of $NaCl = 0$, even though the oxidation state of Na^+ in this bond is +1 and the oxidation state of the chlorine atom, Cl^- , is -1. When you add them together they equal 0. In the case of an ion, the overall charge is always indicated. For example, the overall charge of a OH^- ion is -1, while the oxygen in the OH^- has a -2 oxidation state and the hydrogen has a +1 oxidation state.)

3. Group 1 metals have an oxidation state of +1 and Group 2 an oxidation state of +2 when they are involved in ionic bonding.
4. The oxidation state of fluorine is -1 in compounds
5. Hydrogen generally has an oxidation state of +1 in compounds
6. Oxygen generally has an oxidation state of -2 in compounds
7. In binary metal compounds, Group 17 (or 7A) elements have an oxidation state of -1, Group 16 (or 6A) of -2, and Group 15 (or 5A) of -3.
8. The oxidation states of other atoms are calculated based on rules 1-7.

Example of Calculating Oxidation States:

What is the oxidation state of Chromium in the chromate anion, CrO_4^{2-} ?

Solution: Looking at oxidation state rules, we see that the overall oxidation state is equal to the charge of the ion, and that oxygen usually takes a -2 oxidation state. With this information we can set up an oxidation state equation to calculate the oxidation state of chromium.

The Oxidation State of Chromium + The Oxidation State of 4 Oxygens = -2

$$\text{Cr} + 4(-2) = -2$$

$$\text{Cr} - 8 = -2$$

$$\text{Cr} = -2 + 8 = +6$$

$$\text{Cr} = +6$$

More Practice with Oxidation States:

1. What is the oxidation state of Chromium in the dichromate anion, $\text{Cr}_2\text{O}_7^{2-}$?
2. What is the oxidation state of carbon in $\text{H}_2\text{C}_2\text{O}_4$?
3. What is the oxidation state of sulfur in $\text{Na}_2\text{S}_2\text{O}_3$?
4. What is the oxidation state of carbon in CO? in CO_2 ?
5. What is the oxidation state of chlorine in ClO_4^- ?

Answers: (1) +6 (2) +3 (3) +2 (4) +2, +4 (5) +7

Combustion reactions almost always involve oxygen in the form of O_2 , and are almost always exothermic, meaning they produce heat. Chemical reactions that give off light and heat are colloquially referred to as "burning." Complete combustion of carbon compounds results in the production of carbon dioxide (CO_2) and water (H_2O). Note that carbon can exist in a range of oxidation states, typically from -4 to +4. The burning of fuels that provides the energy to maintain our civilization and the metabolism of foods that furnish the energy that keeps us alive both involve redox reactions.

All combustion reactions are also redox reactions. The general formula for a combustion reaction is:

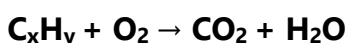

One specific example is the burning of acetylene (C_2H_2) in torches:

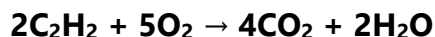

Oxygen (in its elemental form) is a crucial reactant in combustion reactions, and it is also present in the products. Combustion reactions can be evaluated for their redox potential by assigning oxidation numbers to each element in the reaction:



1. First evaluate the reactants side: Start with C_2H_2

C_2H_2	C	H	overall charge
number of atoms	2	2	
oxidation state	-1	+1	
total charge	-2	+2	0

2. Then evaluate O_2 . Since oxygen is in its elemental form, the oxidation state is zero = 0

3. Then evaluate the products side: Start with CO_2

CO_2	C	O	overall charge
number of atoms	1	2	
oxidation state	+4	-2	
total charge	+4	-4	0

4. Then evaluate H_2O . H takes the +1 state and O takes the -2 state.

5. Finally, write in the values on the equation and evaluate the redox states

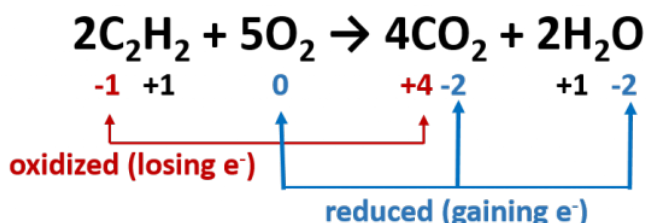

Overall in combustion reactions, the hydrocarbon (in this case, acetylene) is oxidized by molecular oxygen to produce carbon dioxide and water. In the process, oxygen is reduced.

In respiration, the biochemical process by which the oxygen we inhale in air oxidizes foodstuffs to carbon dioxide and water, redox reactions provide energy to living cells. A typical respiratory reaction is the oxidation of glucose ($\text{C}_6\text{H}_{12}\text{O}_6$), a simple sugar.

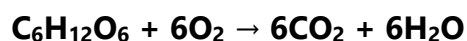

Inside the body, the reaction is controlled to harvest the energy released so that it can be utilized for the production of ATP. Some of the energy released is also used to generate heat for the organism, but not in the rapid form of a combustion reaction that produces fire. Note that in redox reactions involving hydrocarbons, that they hydrogens are usually removed with the electrons. Thus, they can be used as an indicator for which molecules are being oxidized and which are being reduced. For example, in the reaction above the

glucose molecule ($C_6H_{12}O_6$) is losing the hydrogens as it is converted to carbon dioxide. As the glucose losing the hydrogens, it is also losing electrons and thus, the glucose is the oxidized component. Similarly, the oxygen on the reactant side is being converted into the water on the product side where it is gaining the hydrogens, and also gaining electrons. Thus, in this reaction, the oxygen is being reduced to water.

Note that reaction classifications can also overlap and fall into more than one category. For example, the hydrogenation reaction presented above in the removal of carbon-carbon double bonds is also an example of a redox reaction. In that reaction, the hydrocarbons are gaining hydrogens and also electrons, as the double bonds are removed forming the saturated hydrocarbons. Thus, the TAGs are being reduced in this reaction. In this case, the oxidized component (H_2) is being entirely used up in this process.

Section 7.3: Oxidation and Reduction Reactions and the Production of ATP

As seen above, organic molecules that contain a lot of carbon and hydrogen bonds have high energy potential and ability to be oxidized to CO_2 and water. Of all the major macromolecules, fats have the highest hydrocarbon content and thus, contain the largest energy potential (9 Cal/g). Proteins and carbohydrates have many more heteroatoms, such as oxygen and nitrogen incorporated into their structures and have less energy potential (4 Cal/g for both proteins and carbohydrates). In this section, we will cover the oxidation potential of organic molecules with oxygen-containing functional groups.

Alcohol Functional Groups

Alcohol functional groups contain the greatest oxidative potential of all the oxygen containing functional groups. The reactivity of alcohols depend on the number of carbon atoms attached to the specific carbon atom that is attached to the -OH group. Alcohols can be grouped into three classes on this basis.

- A primary (1°) alcohol is one in which the carbon atom (in red) with the OH group is attached to **one** other carbon atom (in blue). Its general formula is RCH_2OH .

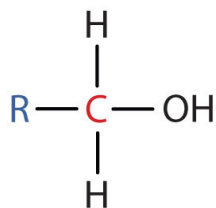

- A secondary (2°) alcohol is one in which the carbon atom (in red) with the OH group is attached to **two** other carbon atoms (in blue). Its general formula is R₂CHOH.

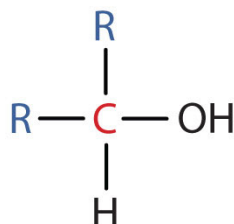

- A tertiary (3°) alcohol is one in which the carbon atom (in red) with the OH group is attached to **three** other carbon atoms (in blue). Its general formula is R₃COH.

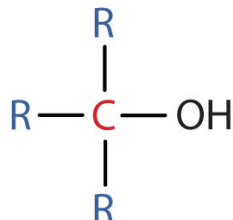

Some alcohols can undergo oxidation reactions. Remember in redox reactions, the component of the reaction that is being oxidized is losing electrons (LEO) while the molecule receiving the electrons is being reduced (GER). In organic reactions, the flow of the electrons usually follows the flow of the hydrogen atoms. Thus, the molecule losing hydrogens is typically also losing electrons and is the oxidized component. The molecule gaining electrons is being reduced. For alcohols, both primary and secondary alcohols can be oxidized. Tertiary alcohols, on the other hand, cannot be oxidized. In many oxidation reactions the oxidizing agent is shown above the reaction arrow as [O]. The oxidizing agent can be a metal or another organic molecule. In the reaction, the oxidizing agent is the molecule that is reduced or accepts the electrons.

In alcohol oxidation reactions, the hydrogen from the alcohol and a hydrogen that is attached to the carbon that has the alcohol attached, along with their electrons, are

removed from the molecule by the oxidizing agent. Removal of the hydrogens and their electrons results in the formation of a carbonyl functional group. In the case of a primary alcohol, the result is the formation of an aldehyde. In the case of a secondary alcohol, the result is the formation of a ketone. Note that for a tertiary alcohol, that the carbon attached to the alcohol functional group does not have a hydrogen atom attached to it. Thus, it cannot undergo oxidation. When a tertiary alcohol is exposed to an oxidizing agent, no reaction will occur.

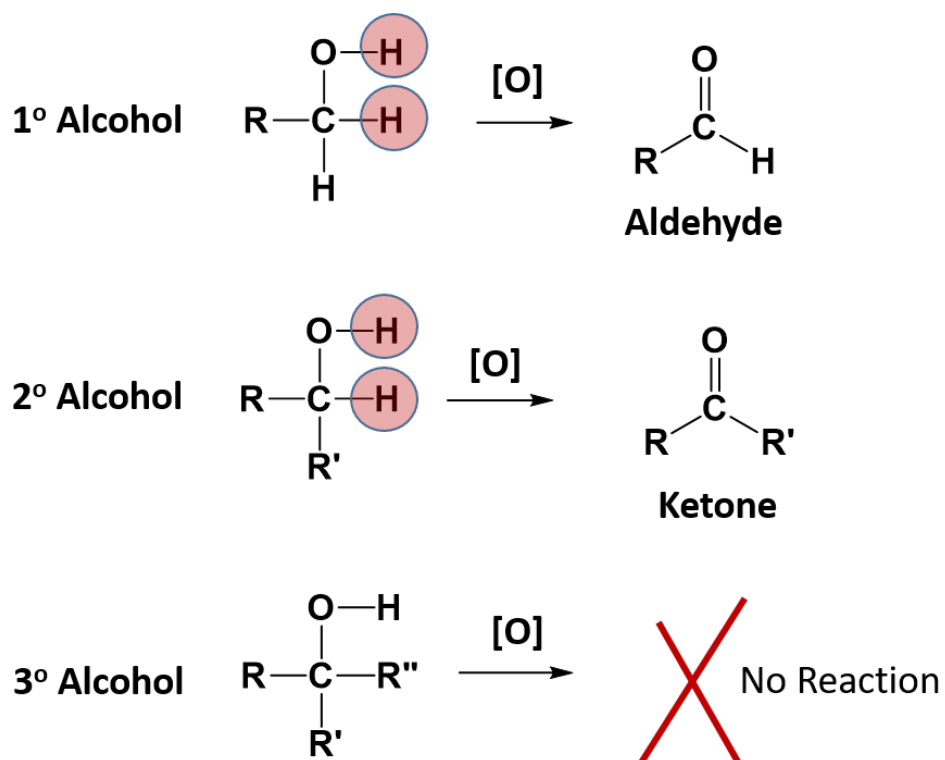

Notice that for the primary alcohol that undergoes oxidation, that it still retains a hydrogen atom that is attached to the carbonyl carbon in the newly formed aldehyde. This molecule can undergo a secondary oxidation reaction with an oxidizing agent and water, to add another oxygen atom and remove the carbonyl hydrogen atom. This results in the formation of a carboxylic acid.

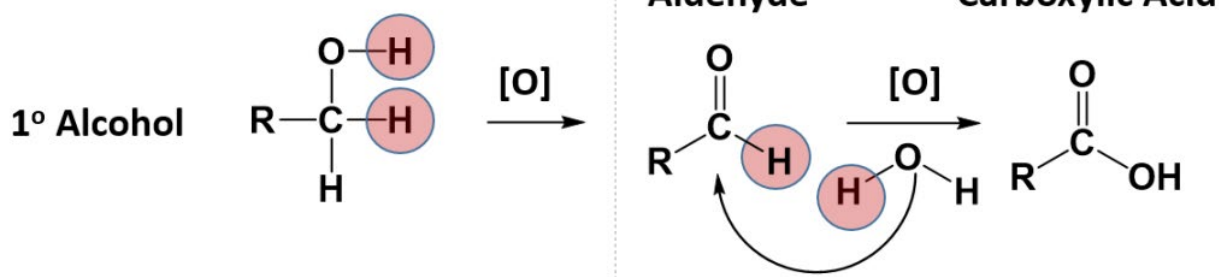

Example Problem:

Write an equation for the oxidation of each alcohol. Use [O] above the arrow to indicate an oxidizing agent. If no reaction occurs, write "no reaction" after the arrow.

1. $\text{CH}_3\text{CH}_2\text{CH}_2\text{CH}_2\text{CH}_2\text{OH}$

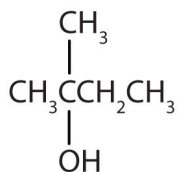

- 2.

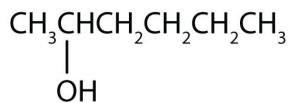

- 3.

Solution:

The first step is to recognize the class of each alcohol as primary, secondary, or tertiary.

1. This alcohol has the OH group on a carbon atom that is attached to only **one** other carbon atom, so it is a primary alcohol. Oxidation forms first an aldehyde and further oxidation forms a carboxylic acid.

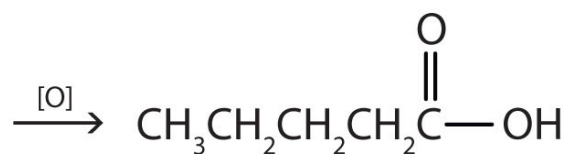
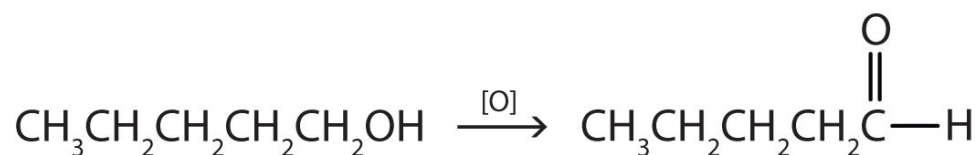

2. This alcohol has the OH group on a carbon atom that is attached to three other carbon atoms, so it is a tertiary alcohol. No reaction occurs.

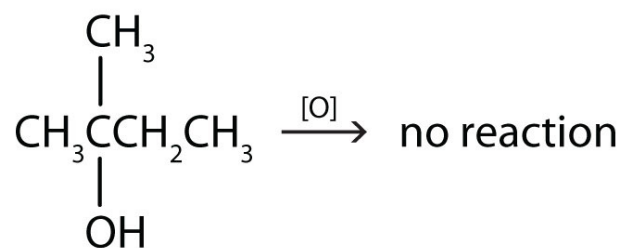

3. This alcohol has the OH group on a carbon atom that is attached to two other carbon atoms, so it is a secondary alcohol; oxidation gives a ketone.

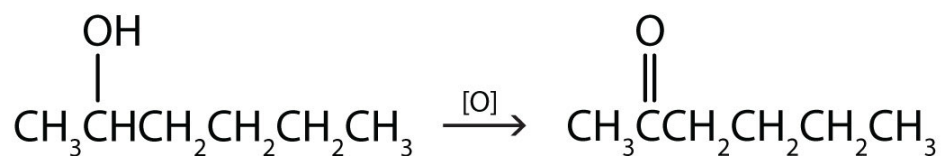

More Practice:

Write an equation for the oxidation of each alcohol. Use [O] above the arrow to indicate an oxidizing agent. If no reaction occurs, write "no reaction" after the arrow.

1.

$$\begin{array}{c}
 \text{OH} \\
 | \\
 \text{CH}_3\text{CH}_2\text{CCH}_2\text{CH}_2\text{CH}_3 \\
 | \\
 \text{CH}_3
 \end{array}$$
2.

$$\begin{array}{c}
 \text{CH}_3\text{CHCHCH}_2\text{OH} \\
 | \\
 \text{CH}_3
 \end{array}$$
3.

$$\begin{array}{c}
 \text{OH} \\
 | \\
 \text{CH}_3\text{CHCHCH}_2\text{CH}_2\text{CH}_3 \\
 | \\
 \text{CH}_3
 \end{array}$$

Aldehyde and Ketone Functional Groups

As shown above in the alcohol section, aldehydes can undergo oxidation to produce a carboxylic acid. This is because the carbonyl carbon atom still retains a hydrogen atom that can be removed and replaced with an oxygen atom. Ketones on the other hand, do not contain a hydrogen atom bound to the carbonyl carbon atom. Thus, they cannot undergo further oxidation. As noted above, ketones that are exposed to an oxidizing agent will have no reaction.

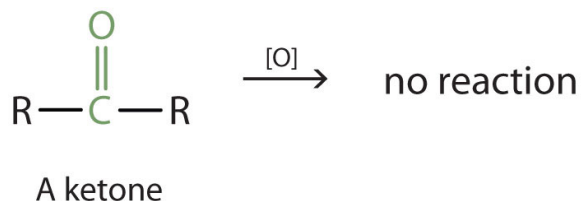
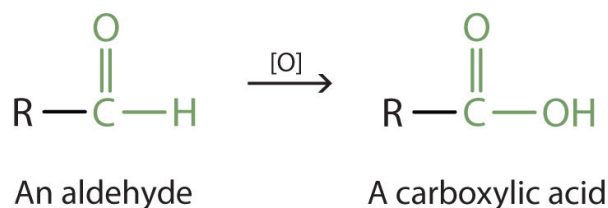

Reduction Reactions

Reduction reactions with aldehydes and ketones revert these compounds to primary alcohols in the case of aldehydes and secondary alcohols in the case of ketones. They are essentially the reverse reactions of the alcohol oxidation reactions.

For example, with the aldehyde, ethanal you get primary alcohol, ethanol:

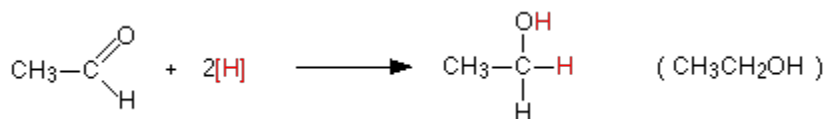

Notice that this is a simplified equation where [H] means "hydrogen from a reducing agent". In general terms, reduction of an aldehyde leads to a primary alcohol.

Reduction of a ketone, such as propanone will give you a secondary alcohol, such as 2-propanol:

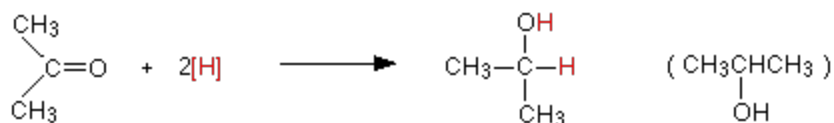

Reduction of a ketone leads to a secondary alcohol.

To Your Health: The Physiological Effects of Alcohols

Methanol is quite poisonous to humans. Ingestion of as little as 15 mL of methanol can cause blindness, and 30 mL (1 oz) can cause death. However, the usual fatal dose is 100 to 150 mL. The main reason for methanol's toxicity is that we have liver enzymes that catalyze its oxidation to formaldehyde, the simplest member of the aldehyde family:

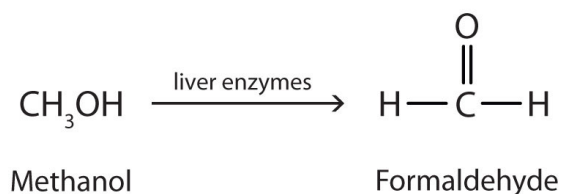

Formaldehyde reacts rapidly with the components of cells, coagulating proteins in much the same way that cooking coagulates an egg. This property of formaldehyde accounts for much of the toxicity of methanol.

Organic and biochemical equations are frequently written showing only the organic reactants and products. In this way, we focus attention on the organic starting material and product, rather than on balancing complicated equations.

Ethanol is oxidized in the liver to acetaldehyde:

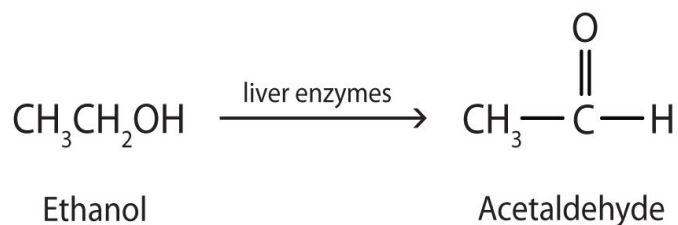

The acetaldehyde is in turn oxidized to acetic acid ($\text{HC}_2\text{H}_3\text{O}_2$), a normal constituent of cells, which is then oxidized to carbon dioxide and water. However, it should be noted that acetaldehyde is toxic and can build up to dangerous levels with chronic, high use of alcohol. The liver is the major site for alcohol metabolism, thus, chronic drinking can lead to liver cirrhosis, a dangerous disease that converts normal liver tissue into scar tissue that can no longer function.

Ethanol itself can also be toxic to humans. The rapid ingestion of 1 pt (about 500 mL) of pure ethanol would kill most people, and acute ethanol poisoning kills several hundred people each year—often those engaged in some sort of drinking contest. Ethanol freely crosses into the brain, where it depresses the respiratory control center, resulting in failure of the respiratory muscles in the lungs and hence suffocation. Ethanol is believed to act on nerve cell membranes, causing a diminution in speech, thought, cognition, and judgment.

While heavy use of alcohol increases the risk of liver disease and for some forms of cancer, some reports that suggest that moderate use of alcohol (no more than 1 drink/day for women of any age and men aged 65 or older; no more than 2 drinks for men under 65) can have some benefits in reducing the risk of heart disease and ischemic stroke. For more information, the [Mayo Clinic](#) has a detailed website that outlines the risks and potential benefits of alcohol consumption.

Rubbing alcohol is usually a 70% aqueous solution of isopropyl alcohol. It has a high vapor pressure, and its rapid evaporation from the skin produces a cooling effect. It is toxic when ingested but, compared to methanol, is less readily absorbed through the skin and can thus be used topically for muscle soreness.

Overall, the processes of oxidation and reduction are critical for life. This is because the oxidation of our food molecules provides enough energy for the cells in our body to recycle the major source of energy for cellular metabolism and other energetic reactions required for life, adenosine triphosphate (ATP) (Figure 7.11). This is also a major building block for RNA biosynthesis. When the phosphate bonds are hydrolyzed to produce ADP and water, there is a large release of energy. The ability of the ATP phosphoester bonds to undergo hydrolysis is the reason it is such a great energy source! The hydrolysis of the last phosphate bond releases the most energy and is most commonly coupled with other reactions that require energy (as seen with the Na^+/K^+ ATPase Pump processes during

the generation of the negative resting potential in neurons in Chapter 3). Once the ATP molecule is broken down to adenosine diphosphate (ADP), it needs to be recycled back to the ATP molecule. The average human will typically use their body weight in ATP every day (60-75 kg)!! However, the amount of ATP/ADP within an average human is only approximately 0.10 mol. This means that each ATP molecule must be recycled between 500-750 times each day! This requires a large energy input that comes from the electrons (e-) and protons (H+) harvested during the oxidation of our food molecules (Figure 7.11).

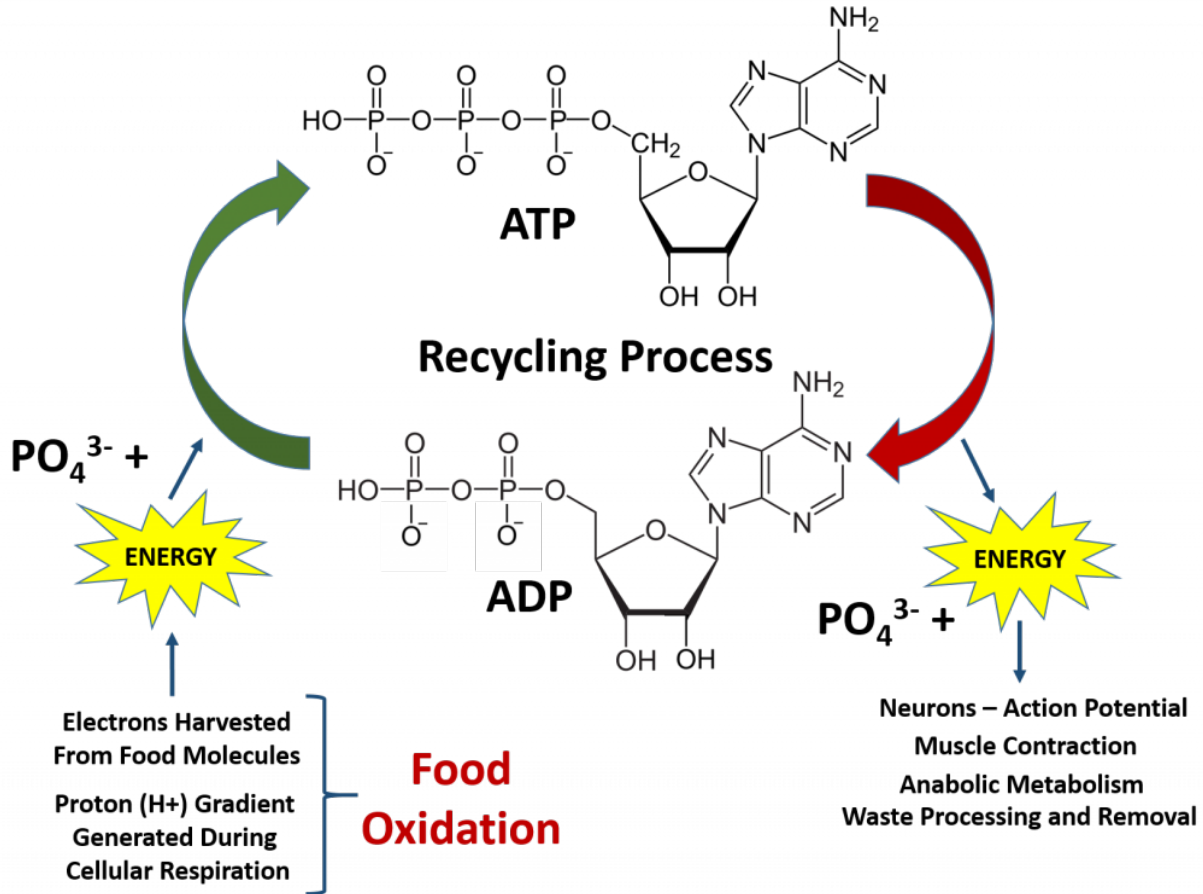

Figure 7.11 ATP/ADP Recycling. ATP is the main energy source within the body. Cleavage of the high energy phosphate bonds releases large amounts of energy that are used for neuron function, muscle contraction, and other metabolic processes in the body. In fact, so much energy is needed to run the human body that each ATP molecule must be recycled an average of 500-750 times per day.

Thought question 1: If there is 0.1 mol of ATP in the body at any one time, *how many molecules of ATP are present in the human body?* If each of these molecules

is recycled 750 times (on a particularly active day), *how many chemical reactions take place just to regenerate this energy source?*

Thought question 2: If there is 0.1 mol of ATP in the body at any one time and the molar mass of ATP 507.181 g/mol, *what is the mass in grams of ATP present in the body?*

The bulk of the ATP molecules are recycled inside the mitochondria. Mitochondria are small organelles within the cell that are thought to have originated as a bacterial symbiont within the cell (Figure 7.12). Mitochondria have a double membrane, with the inner membrane being highly convoluted and folded, providing a lot of surface area for embedded membrane proteins. Mitochondria also contain their own circular DNA which is reminiscent of their bacterial origin.

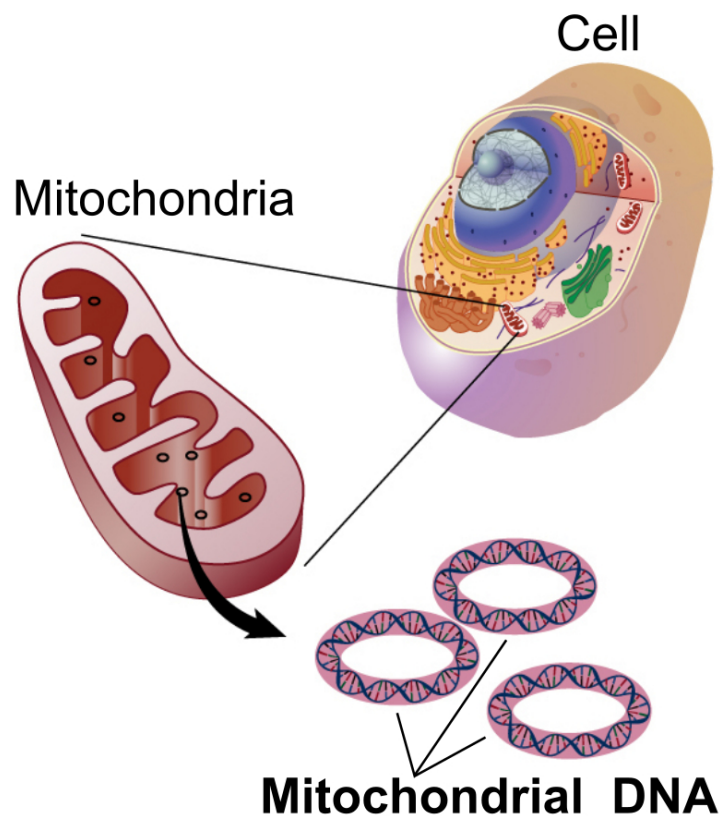

Figure 7.12 Basic Structure of a Mitochondria. The mitochondria are commonly known as the powerhouse of the cell, as this is the primary site where ADP is recycled into ATP.

Figure by: [National Human Genome Research Institute](https://www.genome.gov/)

As food is ingested, the large macromolecules (proteins, carbohydrates, and lipids) are digested into their monomer units. The monomer units, such as glucose from starch or fatty acids from TAGs, are delivered to cells where they can be used as an energy source to regenerate ATP from ADP. This regeneration process is called oxidative phosphorylation. The term oxidative is used because the food molecules are fully oxidized to carbon dioxide (CO_2) during the process to release energy. Phosphorylation is the process of adding a phosphate group to a molecule. In this case, the energy that is harvested from the oxidation of the food molecules, specifically the electrons and protons, is being used to phosphorylate ADP back into an ATP (Figure 7.13).

Most of the oxidation reactions in the breakdown of food molecules take place in the interior of the mitochondria, called the matrix. The electrons (e^-) and protons (H^+) harvested in this process are transported by carrier molecules to the inner membrane of the mitochondria (Figure 7.13). Once they reach the inner membrane, the electrons are delivered to a series of proton pump proteins. Using the energy of the electrons, the proton pumps move H^+ against their concentration gradient into the intermembrane space of the mitochondria. The intermembrane space is the area between the two membranes of the mitochondria (the inner membrane and the outer membrane).

As the intermembrane space becomes full of protons, this creates a ***gradient potential***. You can think of a gradient potential in a similar way that humans will use the power of water in a dam to generate electricity. The dammed water holds potential energy when there is high water in the dam. When the dam is opened in a controlled way to allow water to flow out, the power of the dammed water moving from an area of high concentration to an area of low concentration is used to turn turbines that can generate electricity. Similarly, in the mitochondria, the protons that are concentrated in the intermembrane space also have potential energy. Energy from this proton gradient is used to produce ATP through a proton channel protein called the ATP synthase. When the ATP synthase is bound to ADP and a phosphate ion (PO_4^{3-}), the channel opens allowing the flow of H^+ ions to move through the channel. The movement of the H^+ ions through the protein causes the protein to turn like a cog wheel or a turbine. This turning process enables ADP and PO_4^{3-} to be joined together forming ATP.

The electrons that have been used to generate the proton gradient end up reducing molecular oxygen (O_2) into water (H_2O). The oxygen supplied for this process is the oxygen that we breathe in through our lungs. Thus, the oxidative phosphorylation process is also known as cellular respiration. This is, in fact, why breathing is crucial for our survival. Without a steady supply of oxygen to accept the electrons moving through the electron transport chain of proton pumps, the electrons would back up and get stuck inside the proton pumps like a traffic jam, blocking the further movement of protons into

the intermembrane space. Without the proton gradient, the production of ATP would no longer be possible. The first organ to run out of ATP during a lack of oxygen is the brain. If you block the passage of oxygen-carrying blood to the brain, a person will pass out in as little as 5 - 10 seconds!

A summary of the oxidative phosphorylation process is shown in Figure 7.13.

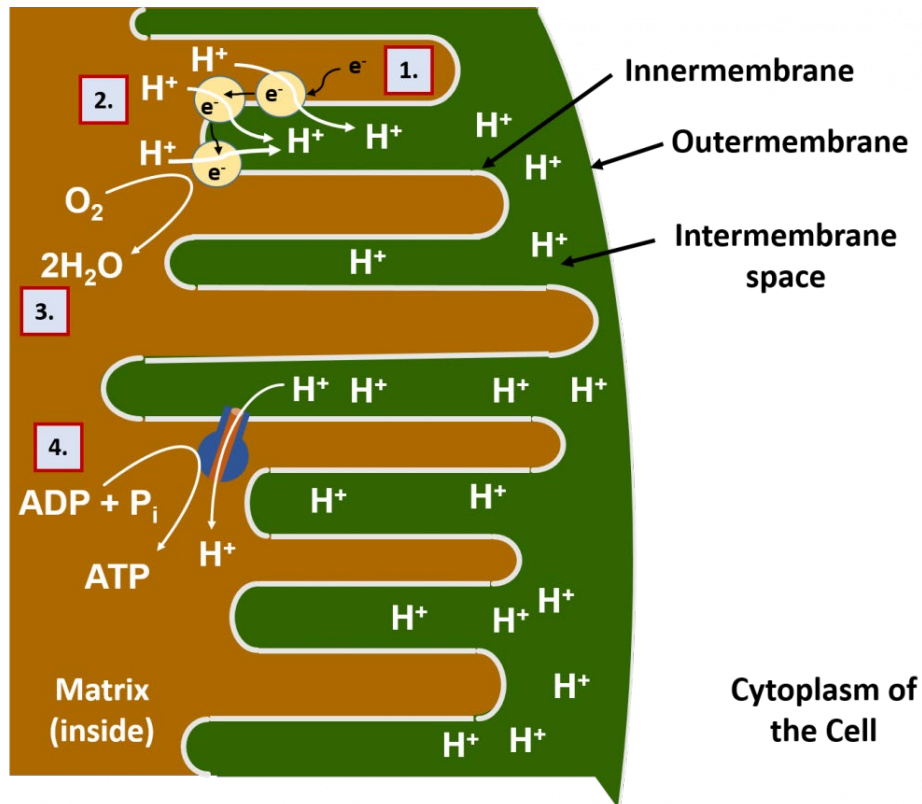

Figure 7.13 Oxidative Phosphorylation in the Mitochondria. (1) Electrons from food molecules are carried to protein pumps in the innermembrane of the mitochondria. (2) Using the energy of the electrons, the protein pumps move protons (H^+) into the intermembrane space, where the protons become concentrated. (Note that the protons also came from the food molecules during the oxidation process - hydrogens and electrons often move together during oxidation!). (3) The electrons are passed through all of the pumps until most of the energy housed in them is spent. Then they are used in combination with protons, to reduce oxygen (O_2) into water (H_2O). (4) The H^+ gradient carries energy potential, just like water that has been dammed. When it flows through the ATP synthase protein, the protein turns like a cog wheel and is able to regenerate ATP.

This Figure was adapted from: [Geraldine Adele Lewis](#)

Section 7.4: Reaction Spontaneity

In the previous sections, you have learned an important key takeaway about chemical reactions: In all types of chemical reactions, bonds are broken and reassembled into new products. You have also learned that energy is stored in chemical bonds. This is the energy of attraction between the atoms involved in the chemical bond and is called the bond energy. Thus, to break a chemical bond requires energy (ie the attraction of the atoms for each other has to be overcome in order to pull them apart). Similarly, when new bonds are formed, energy is released as the formation of the bond creates a more stable situation for each of the atoms involved in the bonds. Overall,

Breaking Bonds = Requires Energy

Forming Bonds = Releases Energy

It is also of note, that not all chemical bonds are created equally. We have learned in previous chapters that some atoms tend to form ionic bonds where they will fully donate or accept electrons between the atoms involved in the bond. Others form covalent bonds where they share electrons between the atoms and sometimes this sharing is unequal creating a polar covalent bond. Thus, for each type of chemical bond, the ***bond energy*** will be different. Each molecule will have its own characteristic bond energies. Other factors that influence the overall energy required for reactions are the physical state of the reactants and products (ie solid, liquid, or gaseous), the temperature of the reaction, and the amounts of reactants and products present. Thus, when assessing whether or not a reaction will proceed ***spontaneously***, it is necessary to determine which side of the equation energy will either be required or released. If the reaction requires more energy to break the bonds on the reactant side than is formed on the product side the reaction is said to be endergonic and will require an input of energy. This type of reaction will ***not be spontaneous***. If the reaction produced by the formation of new bonds on the product side is more than the energy required to break the chemical bonds on the reactant side of the equation, the reaction will release energy and is said to be ***exergonic***. Exergonic reactions will happen spontaneously. Reaction spontaneity can be evaluated graphically for a chemical reaction using a Gibbs Free Energy diagram (Figure 7.14). By measuring ***Changes in the Gibbs Free Energy (ΔG)*** between the products and the reactants of a reaction it is possible to determine the amount of free energy available to do useful work. If the ***ΔG is negative the reaction is spontaneous***, and if the ***ΔG is positive the reaction is not spontaneous***. If ***$\Delta G = 0$*** the reaction is in a state of equilibrium, meaning that the

forward reaction is happening at an equal rate as the reverse reaction and there is no net gain or loss of reactants and products.

Note that reaction spontaneity does not depend on the presence or absence of an enzyme (ie. the presence of an enzyme cannot change a nonspontaneous reaction into a spontaneous reaction.)

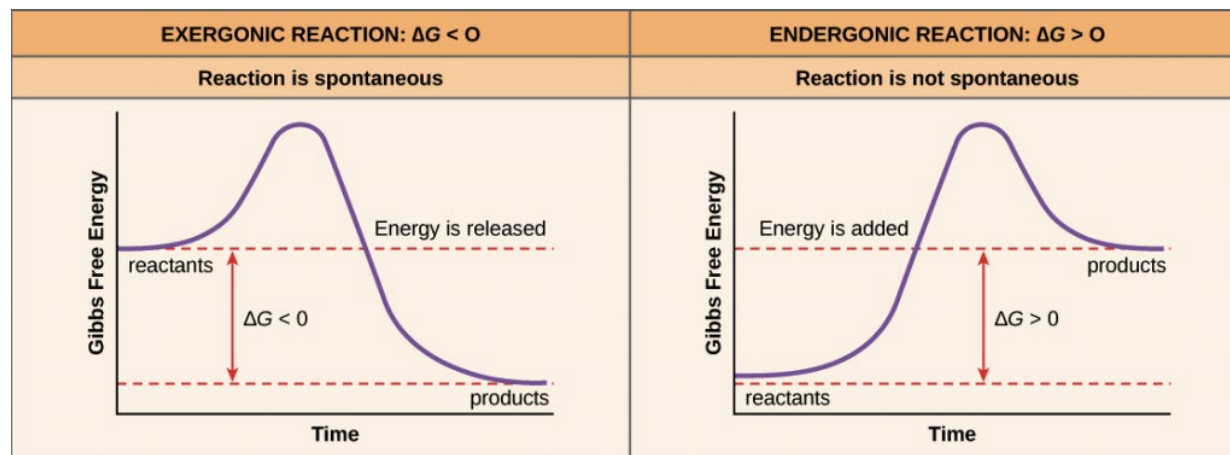

Figure 7.14 Gibbs Free Energy Diagrams. When reactions are spontaneous and release energy (exergonic) the ΔG will be negative (left hand graph), whereas when reactions are not spontaneous and require energy to be added to the reaction (endergonic) the ΔG will be positive (right hand graph).

Figure provided by [The Khan Academy](https://www.khanacademy.com)

Section 7.5: Enzyme-Mediated Reactions

The single most important property of enzymes is the ability to increase the rate chemical reactions occurring in living organisms, a property known as **catalytic activity**. Enzymes speed up the rate of reactions because they lower energy required to get to the transition state of the reaction. The transition state of the reaction is an unstable intermediate structure formed during the reaction process. For example, in Figure 7.9 showing the reaction mechanism of an ester formation, step 3 which contains 5 bonds to the central carbon atom represents the unstable transition state of this reaction. The transition state has the highest energy of the reaction and is noted on the Gibbs Free Energy Diagram as the pinnacle of the 'hill' that occurs between the reactant and product energies (Figure 7.15). When enzymes or catalysts are present, the transition state energy is lowered which

in turn has an exponential effect on the reaction rate (Figure 7.15). Thus, enzymes can increase the reaction rate by many orders of magnitude.

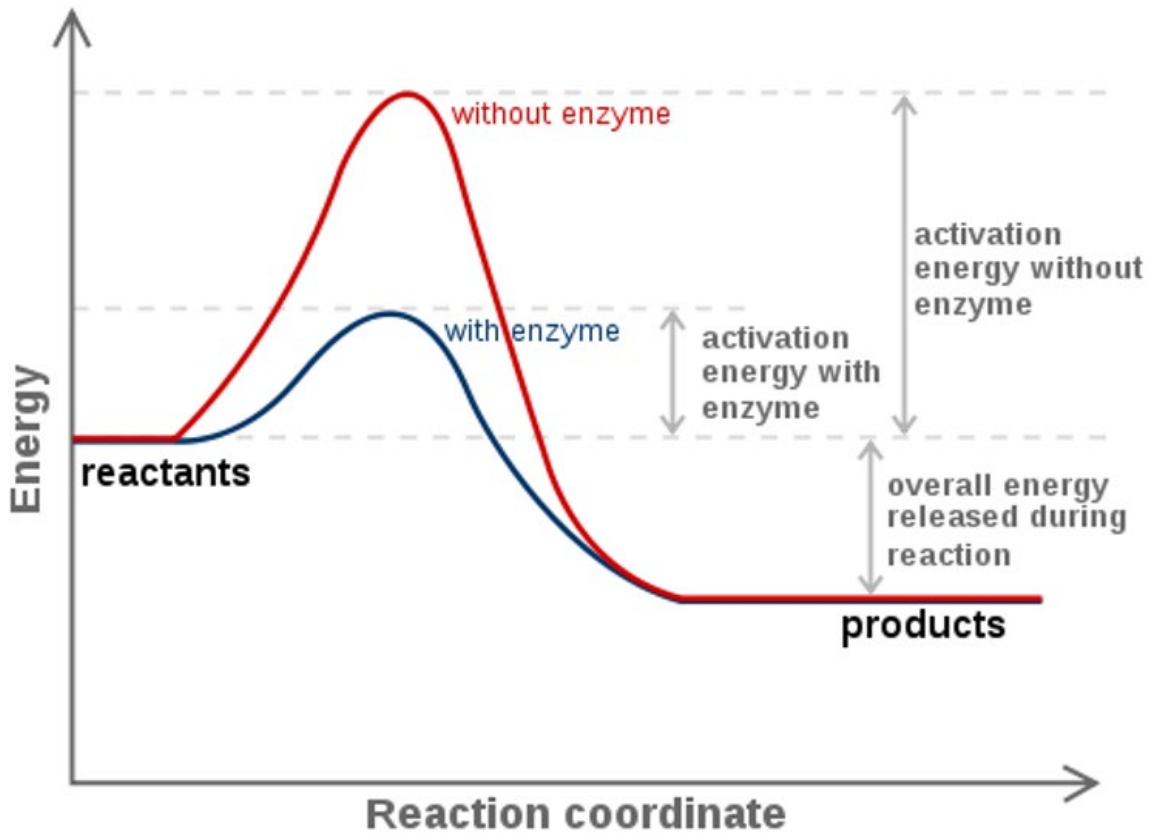

Figure 7.15 Gibbs Free Energy Diagram of an Enzyme Mediated Reaction. The reaction energy of an uncatalyzed reaction is shown in red. Note that the transition state of the reaction is the most unstable part of the reaction and thus, is the position on the graph with the highest free energy. The difference in energy between the transition state and the reactants is called the Gibbs free energy of activation, commonly known as activation energy (ΔG^\ddagger). In the presence of an enzyme (blue line) The activation energy is lowered which causes an exponential increase in the reaction rate. Note that the presence of the enzyme does not change the Gibbs Free Energy of the reactants or of the products. Thus, the presence or absence of an enzyme **DOES NOT** determine the spontaneity of a reaction.

Figure is adapted from [Fvasconcellos](#)

Because most enzymes are proteins, their activity is affected by factors that disrupt protein structure, as well as by factors that affect catalysts in general. Factors that disrupt or denature protein structure include temperature and pH; factors that affect catalysts in general include reactant (substrate) concentration and enzyme concentration. The activity of an enzyme can be measured by monitoring either the rate at which a substrate disappears or the rate at which a product forms.

Concentration of Substrate

In the presence of a given amount of enzyme, the rate of an enzymatic reaction increases as the substrate concentration increases until a limiting rate is reached, after which further increase in the substrate concentration produces no significant change in the reaction rate (part (a) of Figure 7.16. At this point, so much substrate is present that essentially all of the enzyme active sites have substrate bound to them. In other words, the enzyme molecules are saturated with substrate. The excess substrate molecules cannot react until the substrate already bound to the enzymes has reacted and been released (or been released without reacting).

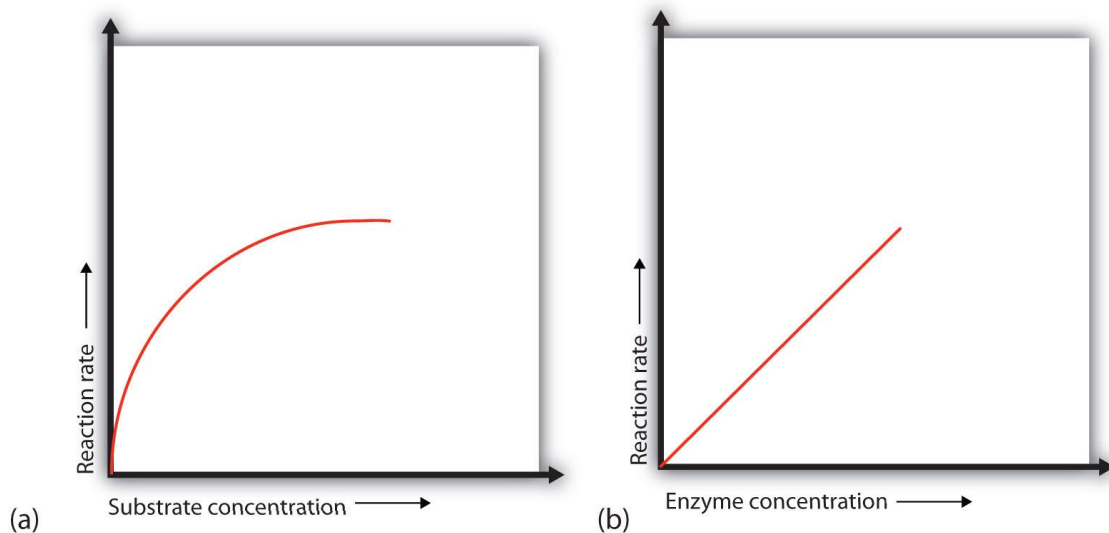

Figure 7.16 Concentration versus Reaction Rate (a) This graph shows the effect of substrate concentration on the rate of a reaction that is catalyzed by a fixed amount of enzyme. (b) This graph shows the effect of enzyme concentration on the reaction rate in biological systems at a constant level of substrate. Note that in biological systems that the enzyme concentration is much smaller than the amount of substrate present. Thus, enzyme concentration increases will never reach the saturation point in biological systems.

Let's consider an analogy. Ten taxis (enzyme molecules) are waiting at a taxi stand to take people (substrate) on a 10-minute trip to a concert hall, one passenger at a time. If only 5 people are present at the stand, the rate of their arrival at the concert hall is 5 people in 10 minutes. If the number of people at the stand is increased to 10, the rate increases to 10 arrivals in 10 minutes. With 20 people at the stand, the rate would still be 10 arrivals in 10 minutes. The taxis have been "saturated." If the taxis could carry 2 or 3 passengers each, the same principle would apply. The rate would simply be higher (20 or 30 people in 10 minutes) before it leveled off.

Concentration of Enzyme

When the concentration of the enzyme is significantly lower than the concentration of the substrate (as occurs in biological systems), the rate of an enzyme-catalyzed reaction is directly dependent on the enzyme concentration [part (b) of Figure 7.16]. This is true for any catalyst; the reaction rate increases as the concentration of the catalyst is increased.

Temperature

A general rule of thumb for most chemical reactions is that a temperature rise of 10°C approximately doubles the reaction rate. To some extent, this rule holds for all enzymatic reactions. After a certain point, however, an increase in temperature causes a decrease in the reaction rate, due to denaturation of the protein structure and disruption of the active site [part (a) of Figure 7.17]. For many human proteins, denaturation occurs between 45°C and 55°C. Note that human body maintains a constant temperature of 37°C. Thus, most proteins have evolved to have maximal activity around this temperature. At high temperatures, the enzymes will melt and denature causing a loss of function, whereas at lower temperatures, the protein cannot kinetically move as fast to mediate the reaction. Other species, such as those found at deep sea thermal vents, will have enzymes specialized for those environments and have different optimal temperature ranges.

At 0°C and 100°C, the rate of enzyme-catalyzed reactions is nearly zero. This fact has several practical applications. We sterilize objects by placing them in boiling water, which denatures the enzymes of any bacteria that may be in or on them. We preserve our food by refrigerating or freezing it, which slows enzyme activity. When animals go into hibernation in winter, their body temperature drops, decreasing the rates of their metabolic processes to levels that can be maintained by the amount of energy stored in the fat reserves in the animals' tissues.

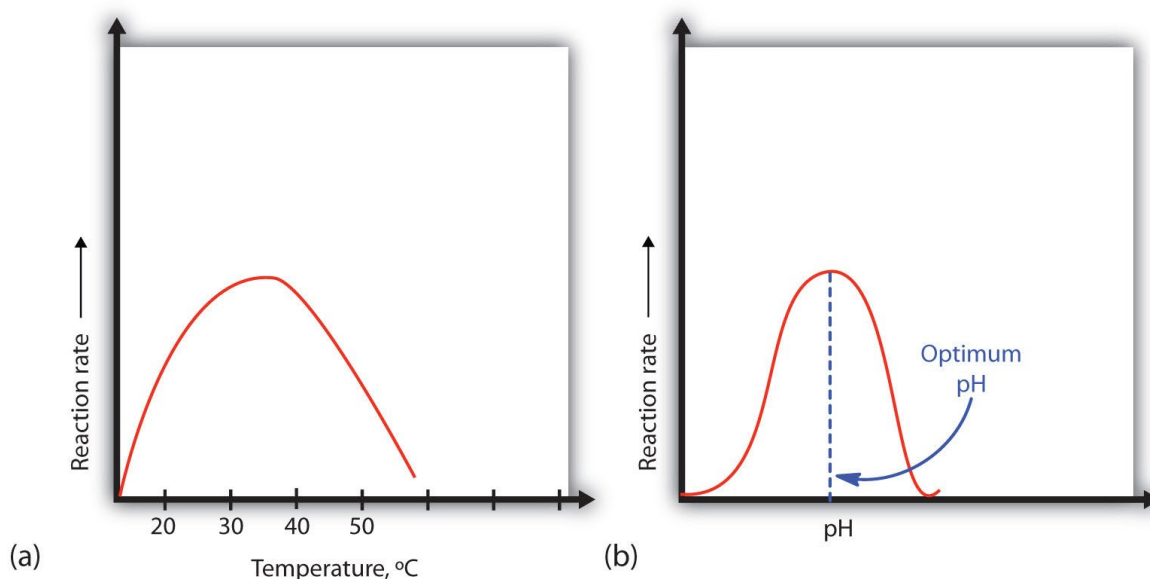

Figure 7.17 Temperature and pH versus Reaction Rate (a) This graph depicts the effect of temperature on the rate of a reaction that is catalyzed by a fixed amount of enzyme. (b) This graph depicts the effect of pH on the rate of a reaction that is catalyzed by a fixed amount of enzyme.

Hydrogen Ion Concentration (pH)

Because most enzymes are proteins, they are sensitive to changes in the hydrogen ion (H^+) concentration or pH. Enzymes may be denatured by extreme levels of hydrogen ions (whether high or low); **any** change in pH, even a small one, alters the degree of ionization of an enzyme's acidic and basic side groups and the substrate components as well. Ionizable side groups located in the active site must have a certain charge for the enzyme to bind its substrate. Neutralization of even one of these charges alters an enzyme's catalytic activity.

An enzyme exhibits maximum activity over the narrow pH range in which a molecule exists in its properly charged form. The median value of this pH range is called the optimum pH of the enzyme [part (b) of Figure 7. 17]. With the notable exception of gastric juice (the fluids secreted in the stomach), most body fluids have pH values between 6 and 8. Not surprisingly, most enzymes exhibit optimal activity in this pH range. However, a few enzymes have optimum pH values outside this range. For example, the optimum pH for pepsin, an enzyme that is active in the stomach, is 2.0.

Section 7.6: Introduction to Pharmacology

Pharmacology is the branch of medicine concerned with the uses, modes and mechanisms of action of drug molecules. The term mechanism of action (**MOA**) refers to the specific biochemical interaction through which a drug substance produces its pharmacological effect. A mechanism of action usually includes mention of the specific molecular targets to which the drug binds, such as an enzyme or receptor. Receptor sites have specific affinities for drugs based on the chemical structure of the drug, as well as the specific action that occurs there. Drugs that do not bind to receptors produce their corresponding therapeutic effect by simply interacting with chemical or physical properties in the body. Common examples of drugs that work in this way are antacids and laxatives. In comparison, **a mode of action (MoA)** describes functional or anatomical changes, at the cellular level, resulting from the exposure of a living organism to a substance.

This section will focus primarily on common drug MOAs. Drugs can act on molecular targets from any of the major macromolecule groups or from mixtures of the different groups. DNA and RNA often form complexes with proteins and many cellular receptors are modified with carbohydrate structures forming both glycoproteins and glycolipids. Drugs can have effects through the binding of molecular targets are very specified locations in the cell as depicted in Figure 7.18

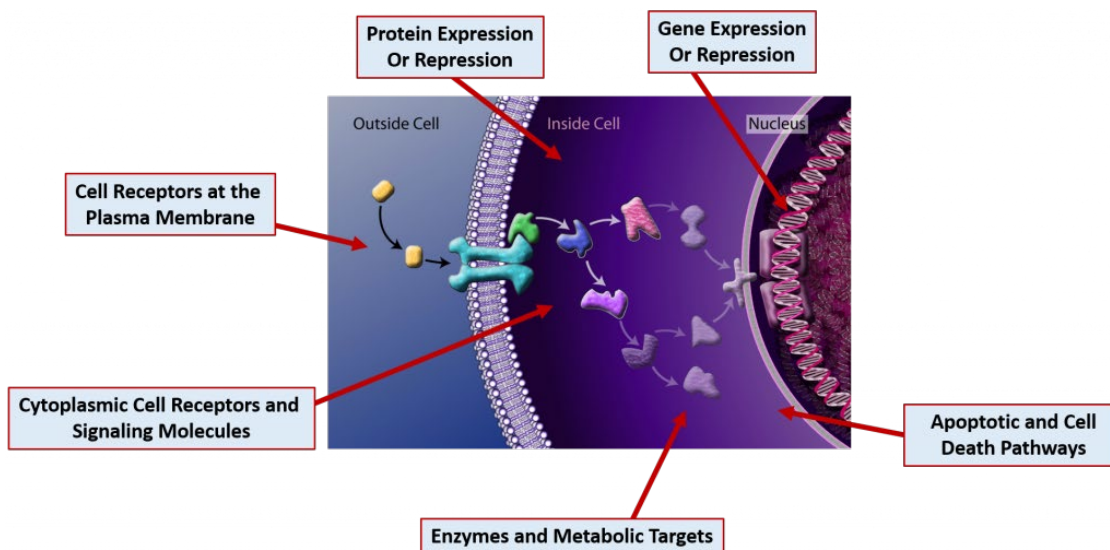

Figure 7.18 Cellular Drug Targets. Drug molecules can bind many different types of cellular targets to mediate their effects. Several are indicated in the diagram above.

The figure is adapted from: [The National Science Foundation](#)

Drugs mediate their effects by acting either as agonists or antagonists. Agonists occupy the normal substrate/ligand binding site and produce a conformational change which leads to enzyme/receptor activation. Antagonists, on the other hand, occupy the active site of a receptor or enzyme, but produce no conformational change and prevent the action of the normal substrate/ligand. When studying these types of molecules, researchers are concerned with two primary properties of the drug molecule, the affinity and the efficacy of the drug. Affinity refers to how well the compound binds to a receptor, where drugs with higher affinity tend to exert greater or more long lasting effects. Efficacy, on the other hand, is a measure of how well the compound activates the receptor. Typically, strong agonists will also have high efficacy, whereas strong antagonists will have low efficacy and inhibit cellular pathways.

Antagonists

Antagonists can be further divided into subcategories based on their mechanism of inhibition. These include competitive, noncompetitive, and irreversible inhibitors (Figure 7.19) Competitive inhibitors will bind reversibly to the same binding site as the normal ligand/substrate. They will move in and out of the active site competing with the binding of the normal substrate and thereby reducing the overall activity of the receptor/enzyme. Since competitive inhibitors don't alter the shape of the drug target and don't permanently block the active site of the drug target, the inhibition that they cause can be overcome by adding additional substrate.

A noncompetitive inhibitor will bind reversibly to a drug target at a distant site from the active site and cause a conformational change that will prevent the binding or activation of the target by the normal substrate. Since noncompetitive inhibitors cause conformational changes to the drug target, the inhibition that they cause cannot be overcome by adding more of the normal substrate. However, the drug target will not be permanently altered. Once the inhibitor is metabolized, the drug target will regain its proper shape and will retain its activity. This type of binding and conformational change is known as allosteric binding. An allosteric binding site is any binding site away from the active site of the drug target.

Finally, irreversible inhibitors will covalently bind to the drug target and permanently alter either the active site directly, or the conformational shape of the drug target such that it is no longer functional.

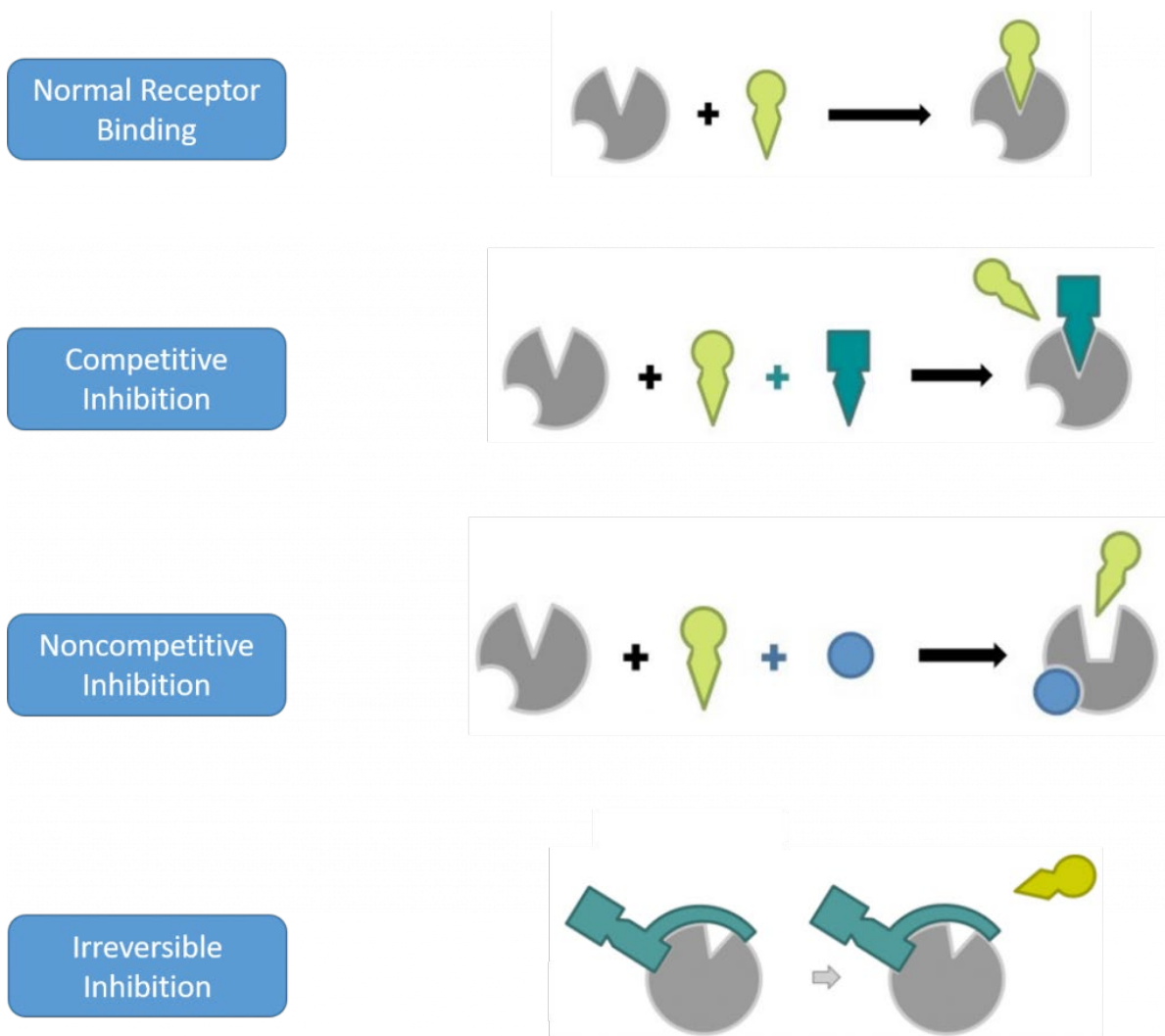

Figure 7.19 Mechanisms of Drug Target Inhibition. In competitive inhibition, the antagonist binds to the active site of the drug target and reversibly inhibits the binding of the normal substrate. In noncompetitive inhibition, the antagonist binds at an allosteric site on the drug target where it causes a conformational change in the shape of the drug target and prevents the normal substrate either from binding to the drug target (as shown above) or it effects the efficacy of the normal substrate by decreasing the drug target activation by the normal substrate. Noncompetitive inhibitors bind reversibly to the drug target and do not permanently alter the drug target. Irreversible inhibitors bind covalently to the drug target and permanently alter its activity.

This figure was adapted from [BioNinja](https://www.bioninja.com.au)

Section 7.7: Chapter Summary

Metabolism is the set of life-sustaining chemical reactions in organisms. Metabolic reactions may be categorized as **catabolic** – the *breaking down* of compounds, or **anabolic** – the *building up* (synthesis) of compounds. Most metabolic reactions in the body require the activity of an **enzyme catalyst**. The enzyme shape is critical to function. Enzymes bind their substrates via the **Lock and Key Model** or the **Induced Fit Model**.

Common types of enzymatic reactions that occur in the body, include: **Group Transfer Reactions** that are mediated by **Transferase Enzymes**, The formation or removal of **Carbon-Carbon Double Bonds** by **Lyase Enzymes**, **Isomerization Reactions** mediated by **Isomerase Enzymes**, **Ligation Reactions** that combine two substrates together and are mediated by **Ligase Enzymes**, **Hydrolysis reactions** that involve the insertion or removal of water from the substrates and are mediated by a **Hydrolase Enzyme**, and **Oxidation and Reduction Reactions** that involve the movement of electrons from one compound to another by **oxidoreductases**.

Dehydration synthesis (mediated by hydrolase enzymes) is used to make all of the major macromolecules in the body. **Lipids** are formed by combining glycerol and fatty acids together with **ester bonds (carboxylic acid + alcohol = ester)**. **Carbohydrates** are formed by combining sugar monomers together with **glycosidic bonds (hemiacetal + alcohol = acetal)**. **Proteins** are formed by combining amino acids together in **peptide bonds (carboxylic acid + amine = amide)**. **Nucleic Acids (DNA/RNA)** are formed by linking nucleotides together in **phosphodiester bonds (phosphoric acid + alcohol à phosphoester)**.

Organic oxidation and reduction reactions commonly involve oxygen containing compounds. With regards to oxidation, **Primary Alcohols** can be oxidized to **Aldehydes** which can be further oxidized to **Carboxylic Acids**. **Secondary Alcohols** can be oxidized to **Ketones**. **Tertiary Alcohols and Ketones CANNOT** be oxidized. With regards to reduction, **Aldehydes** can be reduced to **Primary Alcohols**. **Ketones** can be reduced to **Secondary Alcohols**.

ATP is the major energy currency within the cell. It is present within the human body at very low concentrations (~ 250 g) However, the average human will use their weight (50 – 75 kg) in ATP every single day! Thus, ATP must continually be recycled within the human body alternating between ADP and ATP. ATP is recycled in the mitochondria in a process called **oxidative phosphorylation**. In this process, energy is taken from food molecules through oxidation. The electrons that are pulled from the food molecules can be used as an energy source to make ATP by phosphorylating ADP. Specifically, the electrons from

food are used in the electron transport chain to create a **proton (H⁺) gradient** in the intermembrane space of the mitochondria. The proton gradient, flows like a river through the ATP synthase protein channel and drives the production of ATP.

Chemical bonds between atoms store energy known as **bond energy**. Each molecule has its own characteristic bond energy. Thus, when breaking a chemical bond, energy needs to be added to overcome the bond energy between the two atoms. When new bonds form they release energy.

For a chemical reaction to be **spontaneous**, the reaction needs to be **exergonic**, or releasing energy as a product of the reaction . If a reaction requires energy input, it is said to be **endergonic** and **will NOT occur spontaneously**. Spontaneity can be measured using the Change in Gibbs Free Energy (ΔG). This can also be represented graphically. **If ΔG is negative**, energy will be released and **the reaction is spontaneous**, whereas **if ΔG is positive**, the reaction requires energy input and is **NOT spontaneous**. **If $\Delta G = 0$, the reaction is at equilibrium** and there is no net movement in either direction.

Many factors will effect the rate of a chemical reaction that is mediated by an enzyme catalyst. These include:

- The concentration of substrate – increasing substrate will increase reaction rates until all the enzyme is saturated with substrate.
- Increasing enzyme concentration will increase the reaction rate
- Altering temperature or pH will alter the reaction rates of an enzyme catalyzed reaction. Enzyme folding and movement is effected by both of these parameters. Thus, enzymes have optimal pH and temperature ranges.

Pharmacology studies the modes and mechanisms of action of drug molecules. Drug molecules can act via several different mechanism within the cell, known as its **mechanism of action (MOA)**. Drugs can mediate their effects by acting as **agonists** (which mimic the normal reaction mechanisms of the body) or **antagonists** (which inhibit normal reaction mechanisms of the body). Drug **affinity** refers to how well a drug will bind its target molecule, whereas **efficacy** is a measure of how well the drug activates its target.

Antagonists inhibit reactions using three main mechanisms.

- **Competitive Inhibition**
- **Noncompetitive Inhibition**
- **Irreversible Inhibition**

In **Competitive inhibition**, the inhibitor binds reversibly with the active site of the enzyme and can be overcome by adding more substrate. **Noncompetitive inhibitors**, on the other hand, bind to an **allosteric site** of the enzyme, away from the active site. Therefore, they cannot be overcome by adding more substrate. Both of these mechanisms are reversible inhibitory processes. **Irreversible inhibitors** bind covalently to the enzyme and permanently alter the shape and function.

Section 7.8: References

1. Farmer, S., Reusch, W., Alexander, E., and Rahim, A. (2016) Organic Chemistry. Libretexts. Available at: https://chem.libretexts.org/Core/Organic_Chemistry
2. Ball, et al. (2016) MAP: The Basics of GOB Chemistry. Libretexts. Available at: [https://chem.libretexts.org/Textbook_Maps/Introductory_Chemistry_Textbook_Maps/Map%3A_The_Basics_of_GOB_Chemistry_\(Ball_et_al.\)/14%3A_Organic_Compounds_of_Oxygen/14.10%3A_Properties_of_Aldehydes_and_Ketones](https://chem.libretexts.org/Textbook_Maps/Introductory_Chemistry_Textbook_Maps/Map%3A_The_Basics_of_GOB_Chemistry_(Ball_et_al.)/14%3A_Organic_Compounds_of_Oxygen/14.10%3A_Properties_of_Aldehydes_and_Ketones)
3. McMurray (2017) MAP: Organic Chemistry. Libretexts. Available at: [https://chem.libretexts.org/Textbook_Maps/Organic_Chemistry_Textbook_Maps/Map%3A_A_Organic_Chemistry_\(McMurry\)](https://chem.libretexts.org/Textbook_Maps/Organic_Chemistry_Textbook_Maps/Map%3A_A_Organic_Chemistry_(McMurry))
4. Soderberg (2015) Map: Organic Chemistry with a Biological Emphasis. Libretexts. Available at: [https://chem.libretexts.org/Textbook_Maps/Organic_Chemistry_Textbook_Maps/Map%3A_A_Organic_Chemistry_With_a_Biological_Emphasis_\(Soderberg\)](https://chem.libretexts.org/Textbook_Maps/Organic_Chemistry_Textbook_Maps/Map%3A_A_Organic_Chemistry_With_a_Biological_Emphasis_(Soderberg))
5. Ophardt, C. (2013) **Biological Chemistry**. Libretexts. Available at: https://chem.libretexts.org/Core/Biological_Chemistry/Proteins/Case_Studies%3A_Proteins/Permanent_Hair_Wave
6. Soderberg, T. (2016) **Organic Chemistry with a Biological Emphasis**. Libretexts. Available at: [https://chem.libretexts.org/Textbook_Maps/Organic_Chemistry_Textbook_Maps/Map%3A_A_Organic_Chemistry_With_a_Biological_Emphasis_\(Soderberg\)](https://chem.libretexts.org/Textbook_Maps/Organic_Chemistry_Textbook_Maps/Map%3A_A_Organic_Chemistry_With_a_Biological_Emphasis_(Soderberg))
7. Ball, et al. (2016) MAP: The Basics of General, Organic, and Biological Chemistry. Libretexts. Available at: [https://chem.libretexts.org/Textbook_Maps/Introductory_Chemistry_Textbook_Maps/Map%3A_The_Basics_of_GOB_Chemistry_\(Ball_et_al.\)](https://chem.libretexts.org/Textbook_Maps/Introductory_Chemistry_Textbook_Maps/Map%3A_The_Basics_of_GOB_Chemistry_(Ball_et_al.))
8. Clark, J. (2017) Organic Chemistry. Libretexts. Available at: https://chem.libretexts.org/Core/Organic_Chemistry/Amides/Reactivity_of_Amides/Polyamides
9. Wikipedia contributors. (2018, December 28). Metabolism. In *Wikipedia, The Free Encyclopedia*. Retrieved 19:28, December 29, 2018, from <https://en.wikipedia.org/w/index.php?title=Metabolism&oldid=875751739>

10. Ball, Hill, and Scott. (2012) Enzyme Activity, section 18.7 from the book Introduction to Chemistry: General, Organic and Biological (v1.0) retrieved on Dec 31, 2018 from <https://2012books.lardbucket.org/books/introduction-to-chemistry-general-organic-and-biological/s21-07-enzyme-activity.html>
11. Wikipedia contributors. (2018, November 29). Mechanism of action. In *Wikipedia, The Free Encyclopedia*. Retrieved 05:00, January 1, 2019, from https://en.wikipedia.org/w/index.php?title=Mechanism_of_action&oldid=871201209

Chapter 8: Homeostasis and Cellular Function

Section 8.1: The Concept of Homeostasis

Homeostasis refers to the body's ability to physiologically regulate its inner environment to ensure its stability in response to fluctuations in external or internal conditions. The liver, the pancreas, the kidneys, and the brain (hypothalamus, the autonomic nervous system and the endocrine system) help maintain homeostasis. The liver is responsible for metabolizing toxic substances and with signaling from the pancreas maintains carbohydrate metabolism. The liver also helps to regulate lipid metabolism and is the primary site of cholesterol production. The kidneys are responsible for regulating blood water levels, re-absorption of substances into the blood, maintenance of salt and ion levels in the blood, regulation of blood pH, and excretion of urea and other waste products. The hypothalamus is involved in the regulation of body temperature, heart rate, blood pressure, and circadian rhythms (which include wake/sleep cycles).

Homeostasis can be influenced by either internal or existing conditions (intrinsic factors) or external or environmental conditions (extrinsic factors) and is maintained by many different mechanisms. All homeostatic control mechanisms have at least three interdependent components for the variable being regulated:

- A **sensor or receptor** that detects changes in the internal or external environment. An example is peripheral chemoreceptors, which detect changes in blood pH.
- The **integrating center or control center** receives information from the sensors and initiates the response to maintain homeostasis. The most important example is the hypothalamus, a region of the brain that controls everything from body temperature to heart rate, blood pressure, satiety (fullness), and circadian rhythms (including, sleep and wake cycles).
- An **effector** is any organ or tissue that receives information from the integrating center and acts to bring about the changes needed to maintain homeostasis. One example is the kidney, which retains water if blood pressure is too low.

The sensors, integrating center, and effectors are the basic components of every homeostatic response. Positive and negative feedback are more complicated mechanisms that enable these three basic components to maintain homeostasis for more complex physiological processes.

Negative Feedback

Negative feedback mechanisms use one of the products of the reaction to reduce the output or activity of the process for the purpose of returning an organ or system to its normal range of functioning. Most homeostatic processes use negative feedback regulation to maintain a specific parameter around a setpoint range that supports life Figure 8.1. However, it should be noted that negative feedback processes are also used for other processes that are not homeostatic.

Within the realm of homeostasis, temperature control is a good example that uses negative feedback. Nerve cells (the sensors) relay information about body temperature to the hypothalamus (the integrating center). The hypothalamus then signals several effectors to return the body temperature to 37°C (the set point). Two effectors activated in the process when core temperature is too high are the sweat glands which serve to cool the skin and the blood vessels which undergo vasodilation (or enlarging) so the body can give off more heat. Once the core temperature is brought back into normal range, the sensor will send negative feedback messages to the integrating center to turn off the process (ie turn off the sweat glands and inhibit further vasodilation). Both internal and external events can induce negative feedback mechanisms. The two examples above represent internal mechanisms utilized to return the body within the normal temperature range. However, we can also mediate the cooling of the body through external factors, such as removing a warm hat and gloves or pouring a cool glass of water over our head. Both external and internal mechanisms for cooling can return the temperature of the body to within the normal range and elicit the negative feedback response. Similarly, if body temperature is below the set point, muscles shiver to generate heat and the constriction of the blood vessels helps the body retain heat.

Homeostatic processes are very complex because the setpoint or normal range might change depending on the circumstance. For example, the hypothalamus can change the body's temperature set point, such as raising it during a fever to help fight an infection.

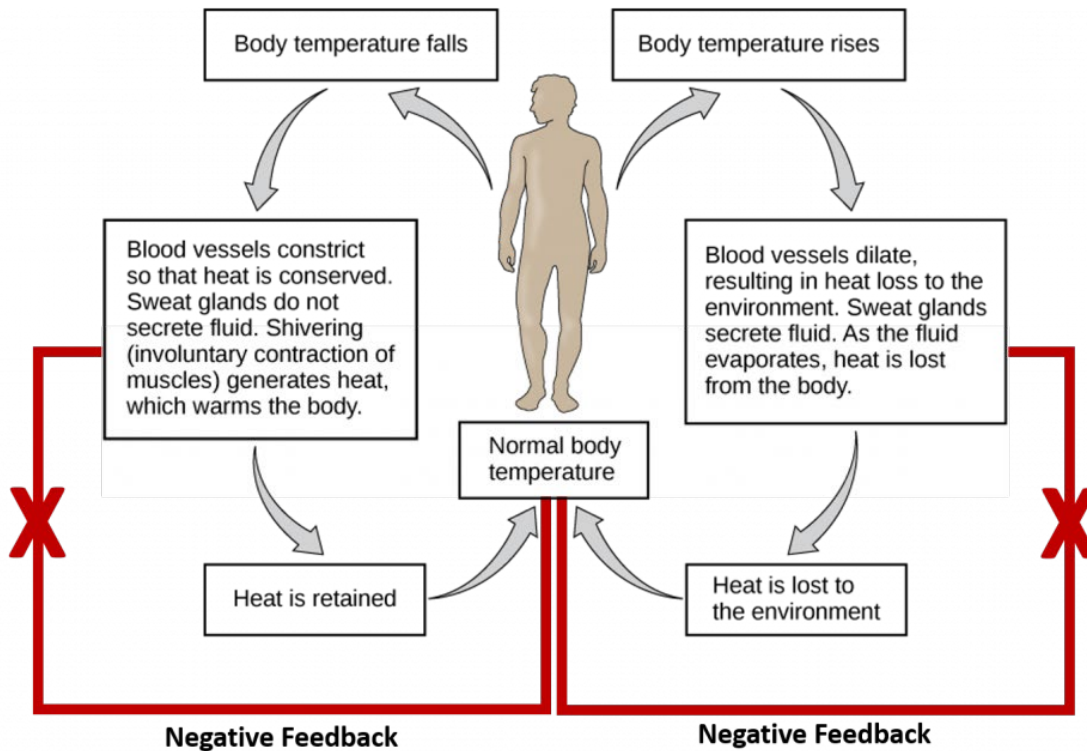

Figure 8.1 Homeostatic Regulation of Temperature in Humans. Core body temperature is maintained at a normal setpoint of 37°C. If the core temperature rises above (right hand side) or drops below (left hand side) the setpoint, internal biological responses are initiated to return the core temperature back to the setpoint range. Once this is achieved, negative feedback loops are initiated to down regulate the internal biological responses so that the core temperature doesn't overshoot the required change.

This Figure is adapted from: [The Kahn Academy](https://www.khanacademy.org/a/homeostasis-and-feedback-loops/a0c03618-4000-4961-8000-000000000000)

Positive Feedback

Positive feedback is a mechanism in which an activated component enhances or further upregulates the process that gave rise to itself in order to create an even stronger response. Positive feedback mechanisms are designed to accelerate or enhance the output created by a stimulus that has already been activated. Positive feedback mechanisms are designed to push levels out of normal ranges and are not used as often in homeostatic responses. To achieve positive feedback, a series of events initiates a cascading process that builds to increase the effect of the stimulus.

An example of a positive feedback loop is the blood clotting cascade which is originally initiated by external damage to the vasculature (Figure 8.2). During a damage event, extrinsic factors begin the initiation of the blood clotting cascade. The proteins involved in this process are usually held inactive by being produced in a much larger form than is required. To activate the protein, the protein needs to be cleaved into a smaller, active complex. When a protein is held in a large inactive state and cleaved to yield the active component, it is called a zymogen. The blood clotting cascade contains many zymogens. The first zymogen to be activated is Factor X. When Factor X is cleaved, it becomes active and proceeds to cleave the next downstream target, Prothrombin II. This produces the active component, Thrombin IIa which has multiple effects. First, it cleaves the protein Fibrinogen to produce Fibrin. Fibrin then begins to form a clotting complex with itself.

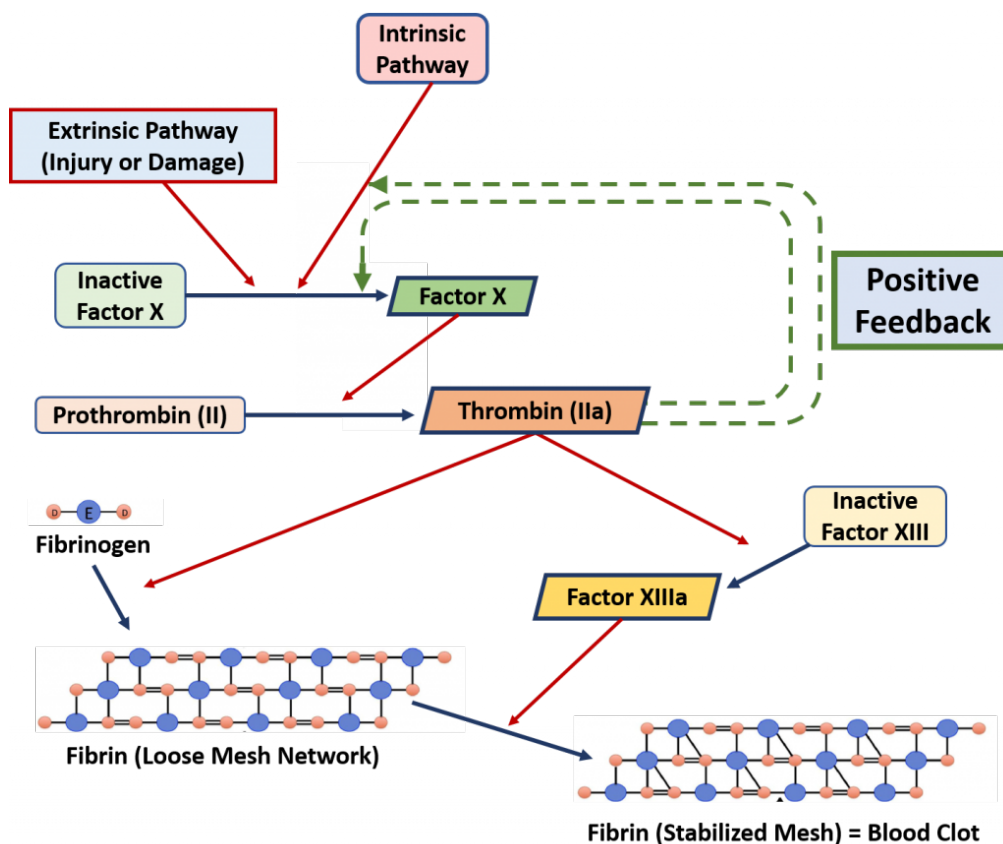

Figure 8.2 The Positive Feedback Mechanism of the Blood Clotting Cascade. Extrinsic factors such as damage or injury activated the cleavage of zymogen proteins in the blood clotting cascade. Activation of the zymogen, Thrombin IIa begins the formation of the fibrin clotting network and also elicits positive feedback that further upregulates the entire clotting cascade.

This Figure is adapted from: [MPT-Matthew](#)

This is referred to as the loose mesh network. Activated Thrombin IIa also cleaves the inactive form of Factor XIII. Activated Factor XIIIa causes crosslinks to form in the loose mesh network creating the finalized stable mesh that forms the blood clot. To accelerate this process further, Thrombin IIa also has two positive feedback effects. It can also cleave Inactive Factor X creating more activated Factor X and ultimately more activated Thrombin IIa. It also increases the activity of the intrinsic blood clotting cascade, which further upregulates the activation of Factor X.

Many parameters are regulated within the body within a narrow homeostatic window to maintain proper functioning and balance within biological systems. Some examples of homeostatic parameters include:

Temperature

Humans are warm-blooded or endothermic, maintaining a near-constant body temperature. Thermoregulation is an important aspect of human homeostasis. Heat is mainly produced by the liver and muscle contractions. Humans have been able to adapt to a great diversity of climates, including hot humid and hot arid environments. High temperatures pose serious stresses for the human body, placing it in great danger of injury or even death. In order to deal with these climatic conditions, humans have developed physiologic and cultural modes of adaptation. When internal temperature reaches extremes of 45°C (113°F), hyperthermia, a condition where an individual's body temperature is elevated beyond normal, occurs and cellular proteins will denature, causing metabolism to stop and ultimately lead to death. Hypothermia is the opposite condition, where internal body temperature falls below homeostatic norms. Hypothermia occurs when body core temperatures fall below 35.0 °C (95.0 °F). Symptoms depend on the temperature. In mild hypothermia there is shivering and mental confusion. In moderate hypothermia shivering stops and confusion increases. In severe hypothermia, there may be paradoxical undressing, in which a person removes their clothing, as well as an increased risk of the heart stopping. Hypothermia has two main types of causes. It classically occurs from exposure to extreme cold. It may also occur from any condition that decreases heat production or increases heat loss. Commonly this includes alcohol intoxication but may also include low blood sugar, anorexia, and advanced age.

Iron

Iron is an essential element for human beings. The control of this necessary but potentially toxic substance is an important part of many aspects of human health and disease. Hematologists have been especially interested in the system of iron metabolism because iron is essential to red blood cells. In fact, most of the human body's iron is contained in

red blood cells' hemoglobin protein where it aids in the binding and transport of oxygen for cellular respiration, and iron deficiency is the most common cause of anemia.

When body levels of iron are too low, an iron-sensitive hormone called hepcidin is decreased in the duodenal epithelium (lining of the small intestine). This causes an increase in ferroportin activity, an iron-selective protein channel embedded in the membrane of intestinal cells. Activation of this channel stimulates iron uptake in the digestive system. An iron surplus will stimulate the reverse of this process.

Sugar

Blood glucose is regulated with two hormones, insulin and glucagon, both released from the pancreas.

When blood sugar levels become too high, insulin is released from the pancreas. Glucose, or sugar, is taken up by cells (especially liver and muscle tissue) where it is stored as glycogen. This results in a lowering of the blood sugar levels. On the other hand, when blood sugar levels become too low, glucagon is released by the pancreas. It promotes the breakdown of glycogen into the glucose monomers within liver cells. The liver cells then release free glucose back into the blood stream and restore blood sugar levels.

Improper glucagon functioning results in hypoglycemia, a condition where blood sugar is too low. This can be life threatening leading to coma and death if not treated promptly. Improper insulin function results in hyperglycemia or increased blood sugar levels. If this state is prolonged the disease called diabetes results. Diabetes will be discussed in more detail in section 8.2 below.

Osmoregulation

Osmoregulation is the active regulation of the osmotic pressure of bodily fluids to maintain the homeostasis of the body's water content; that is it keeps the body's fluids from becoming too dilute or too concentrated. Osmotic pressure is a measure of the tendency of water to move into one solution from another by osmosis. The higher the osmotic pressure of a solution the more water wants to go into the solution.

The kidneys are used to remove excess ions (such as Na^+ , K^+ and Ca^{2+}) from the blood, thus affecting the osmotic pressure. These are then expelled as urine. The kidneys are also important for maintaining acid/base levels, such that the pH of the blood remains close to the neutral point.

Water Volume

The kidneys also determine the overall water volume maintained within the body. The hormones Anti-Diuretic Hormone (ADH), also known as vasopressin, and Aldosterone play a major role in regulating kidney function. If the body is fluid-**deficient**, there will be an increase in the secretion of ADH from the pituitary gland. This hormone then travels to the distal tubules or collecting ducts of the kidneys, causing fluid to be retained and urine output to be reduced. Similarly, the hormone aldosterone, a mineralcorticoid hormone with a steroid backbone, is secreted from the adrenal cortex. Aldosterone causes the kidneys to reabsorb Na^+ . As Na^+ is reabsorbed, water is reabsorbed as well. Thus, Na^+ retention also leads to fluid retention (Figure 8.3). Conversely, if fluid levels are **excessive**, secretion of the hormone (aldosterone) is suppressed, resulting in less retention of fluid by the kidneys and a subsequent increase in the volume of urine produced.

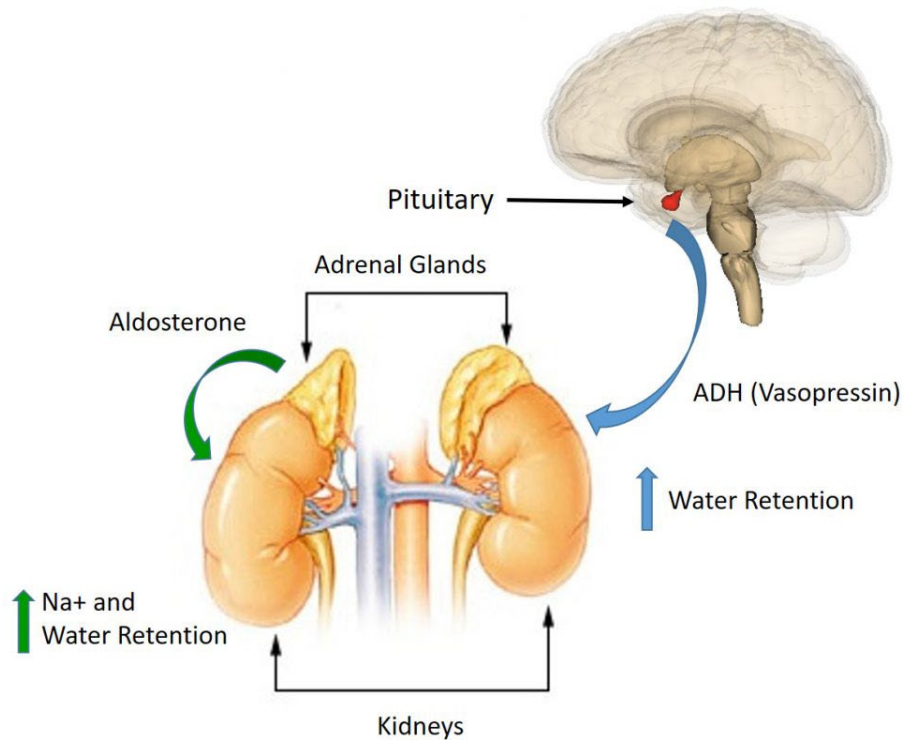

Figure 8.3: Effects of Aldosterone and ADH on Kidney Function. When fluid levels in the body are low, ADH (Vasopressin) is secreted by the pituitary gland and Aldosterone is secreted by the adrenal glands. ADH decreases the loss of water whereas Aldosterone increases the reabsorption of Na^+ within the collecting duct of the kidneys. Water is reabsorbed with the Na^+ causing an increase in fluid retention and decreased urine output.

This figure has been modified from: [EEOC](#) and [Wikimedia Commons](#).

Hemostasis

Hemostasis is the process whereby bleeding is halted. A major part of this is the coagulation cascade highlighted in Figure 8.2.

Platelet accumulation causes blood clotting in response to a break or tear in the lining of blood vessels. Unlike the majority of control mechanisms in human body, the hemostasis utilizes positive feedback, for the more the clot grows, the more clotting occurs, until the blood stops.

Sleep

Sleep timing depends upon a balance between **homeostatic sleep propensity**, the need for sleep as a function of the amount of time elapsed since the last adequate sleep episode, and circadian rhythms which determine the ideal timing of a correctly structured and restorative sleep episode. A sleep deficit will elicit a compensatory increase in the intensity and duration of sleep, while excessive sleep reduces sleep propensity.

Section 8.2: Disease as a Homeostatic Imbalance

What Is Disease?

Disease is any failure of normal physiological function that leads to negative symptoms. While disease is often a result of infection or injury, most diseases involve the disruption of normal homeostasis. Anything that prevents positive or negative feedback system from working correctly could lead to disease if the mechanisms of disruption become strong enough.

Aging is a general example of disease as a result of homeostatic imbalance. As an organism ages, weakening of feedback loops gradually results in an unstable internal environment. This lack of homeostasis increases the risk for illness and is responsible for the physical changes associated with aging. Heart failure is the result of negative feedback mechanisms that become overwhelmed, allowing destructive positive feedback mechanisms to compensate for the failed feedback mechanisms. This leads to high blood pressure and enlargement of the heart, which eventually becomes too stiff to pump blood effectively, resulting in heart failure. Severe heart failure can be fatal.

Diabetes: A Disease of Failed Homeostasis

Diabetes, a metabolic disorder caused by excess blood glucose levels, is a key example of disease caused by failed homeostasis. In ideal circumstances, homeostatic control mechanisms should prevent this imbalance from occurring. However, in some people, the mechanisms do not work efficiently enough or the amount of blood glucose is too great to be effectively managed. In these cases, medical intervention is necessary to restore homeostasis and prevent permanent organ damage.

Normal Blood Sugar Regulation

The human body maintains constant levels of glucose throughout the day. After a meal, blood glucose levels rise, as glucose is transported from the small intestine into the blood stream. In response to this, the pancreas (the sensor) releases insulin into the bloodstream where it acts as a hormone. As you learned in Chapter 6, hormones are molecules that are made in one part of the body, secreted into the bloodstream and are transported to a distant part of the body, where they mediate an effect or reaction at that secondary target. Insulin is a peptide hormone that is released by the pancreas in response to elevated levels of blood glucose. Insulin binds with high efficiency to receptor proteins on the surface of liver cells, where it turns on signaling within the liver to increase the uptake of glucose from the bloodstream (Figure 8.4). Other body cells, such as skeletal muscle, adipose tissue, and brain cells are also activated by insulin. When a molecule has multiple different effects on the body, these multiple effects are called pleiotropic effects. These other cell types will also take up glucose to use as an energy source. This lowers blood glucose levels back to normal levels. The liver can take up more glucose than other tissue types and convert it into a large carbohydrate molecule called glycogen, that you learned about in Chapter 6. It is stored as this carbohydrate until glucose is needed when it can then be broken down to released back into the blood stream. Up to 10% of the volume in liver cells is in the form of glycogen.

In between meals or during times of fasting, blood glucose levels begin to drop. This activates the pancreas to secrete a different hormone, called glucagon. Glucagon signaling activates the liver to begin breaking down the glycogen storage molecule into free glucose. The glucose is then released back into the blood stream, increasing blood glucose levels (Figure 8.4).

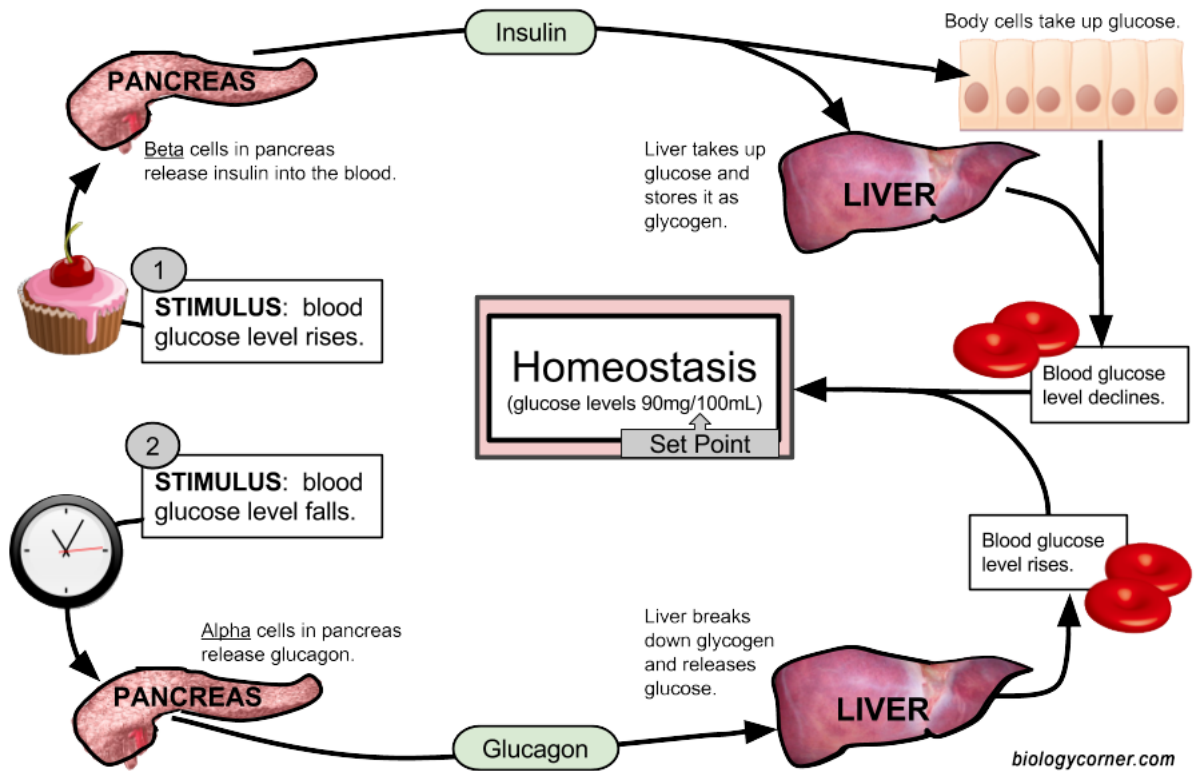

Figure 8.4 Glucose Homeostasis. When blood sugar rises due to a meal (Path 1), the pancreas senses the increase in blood glucose levels. In response, it releases the peptide hormone, insulin. Insulin interacts with downstream target cells in the body, including liver and muscle tissue, where it causes the uptake of glucose from the blood stream into the cell. The excess glucose is stored as the carbohydrate, glycogen. This returns blood glucose levels back to normal. If it has been several hours after eating a meal, blood glucose levels will begin to fall (Path 2). This signals liver cells to breakdown glycogen into glucose monomers. The glucose can then be released back into the bloodstream.

Figure is by: [Shannan Muskopf](https://www.biologycorner.com) from [Biologycorner.com](https://www.biologycorner.com)

Over the course of a day, blood glucose levels will fluctuate modestly around the homeostatic set point (Figure 8.5). As meals are eaten, this triggers a rise in blood glucose that is counteracted by the secretion of insulin. In between meals, blood glucose levels fall, and glucagon is released by the pancreas to signal to the liver to release glucose back into the blood stream.

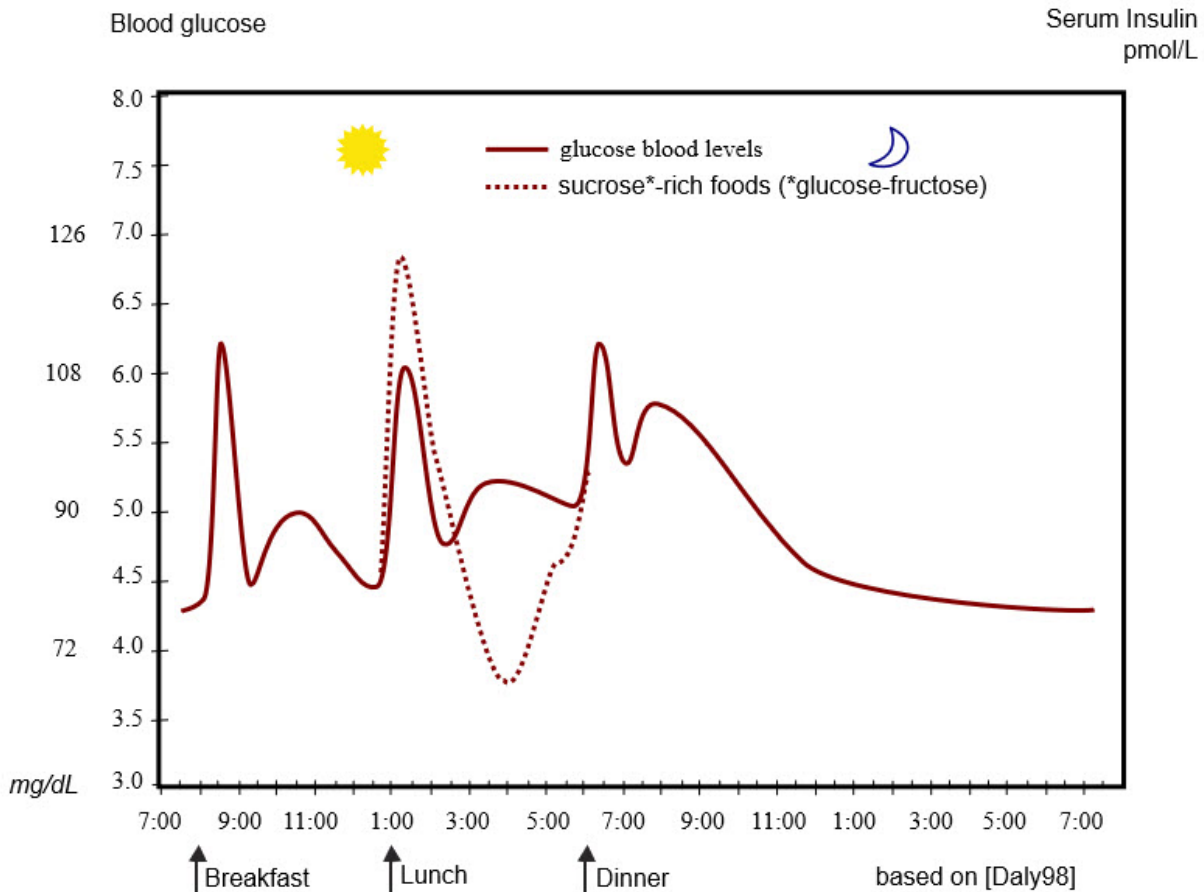

Figure 8.5. Homeostasis of Glucose Metabolism: This image illustrates glucose metabolism over the course of a day. Homeostasis may become imbalanced if the pancreas is overly stressed, making it unable to balance glucose metabolism. This can lead to diabetes.

Causes of Homeostatic Disruption

People with type 1 diabetes do not produce insulin due to auto-immune destruction of the insulin producing cells, while people with type 2 diabetes have chronic high blood glucose levels that cause insulin resistance to develop. With diabetes, blood glucose is increased by normal glucagon activity, but the lack of or resistance to insulin means that blood sugar levels are unable to return to normal. This causes metabolic changes that result in diabetes symptoms like weakened blood vessels and frequent urination. Diabetes is normally treated with insulin injections, which replaces the missing negative feedback of normal insulin secretions. If diabetes is left untreated or becomes resistant to treatment,

more serious side effects are seen, including peripheral neuropathy (loss of feeling in the extremities), loss of circulation in the extremities, blurred vision and/or blindness.

Overall, **Diabetes** is a disease caused by a broken feedback loop involving the hormone insulin. The broken feedback loop makes it difficult or impossible for the body to bring high blood sugar down to a healthy level.

Section 8.3: Measuring Homeostasis to Evaluate Health

Since homeostatic imbalances can lead to disease states or even death, homeostasis has been identified as one of the eight core concepts of biology. The American Association of Medical Colleges reports that a physician's ability to identify and apply knowledge about homeostasis should be regarded as one of their key competencies. Thus, physicians need a way to evaluate the homeostatic health of their patients. They need to be able to evaluate the mixtures of compounds that are found within the human body.

Recall that in Chapter 2, you were introduced to the concept of a **mixture**, which is a substance that is composed of two or more substances. Also recall that mixtures can be of two types: Homogeneous and Heterogeneous, where homogeneous mixtures combine so intimately that they are observed as a single substance, even though they are not. Heterogeneous mixtures, on the other hand, are non-uniform and have regions of the mixture that look different from other regions of the mixture. Homogeneous mixtures can be further broken down into two classifications: Colloids and Solutions. A colloid is a mixture that contains particles with diameters ranging from 2 to 500 nm. Colloids appear uniform in nature and have the same composition throughout but are cloudy or opaque. Blood is a good example of a colloid. True solutions, on the other hand, have particle sizes of a typical ion or small molecule (~0.1 to 2 nm in diameter) and are transparent, although they may be colored. The remaining sections of this chapter will focus on the characteristics of true solutions.

Solutions are all around us. Air, for example, is a solution. If you live near a lake, a river, or an ocean, that body of water is not pure H₂O but most probably a solution. Much of what we drink—for example, soda, coffee, tea, and milk are solutions. Solutions are a large part of everyday life. A lot of the chemistry occurring around us happens in solution. In fact, much of the chemistry that occurs in our own bodies takes place in solution, and many solutions—such as the Ringer's lactate IV solution—are important in healthcare. In our understanding of chemistry, we need to understand a little bit about solutions. In this

chapter, you will learn about the special characteristics of solutions, how solutions are characterized, and some of their properties.

The major component of the **solution** is called the **solvent**, and the minor component(s) are called the **solute**. If both components in a solution are 50%, the term solute can be assigned to either component. When a gaseous or solid material dissolves in a liquid, the gas or solid material is called the **solute**. When two liquids dissolve in each other, the major component is called the **solvent** and the minor component is called the **solute**. Many chemical reactions are carried out in solutions, and solutions are also closely related to our everyday lives. The air we breathe, the liquids we drink, and the fluids in our body are all solutions. Furthermore, we are surrounded by solutions such as the air and waters (in rivers, lakes and oceans).

Types of Solutions

Material exists in three states: solid, liquid, and gas. Solutions also exist in all these states:

1. Gaseous mixtures are usually homogeneous and are commonly **gas-gas solutions**. For quantitative treatment of this type of solutions, we will devote a unit to gases. The atmosphere is a gaseous solution that consists of nitrogen, oxygen, argon, carbon dioxide, water, methane, and some other minor components. Some of these components, such as water, oxygen, and carbon dioxide may vary in concentration in different locations on the Earth depending on factors such as temperature and altitude.
 2. When molecules of gas, solid or liquid are dispersed and mixed with those of liquid, the homogeneous (uniform) states are called **liquid solutions**. Solids, liquids and gases dissolve in a liquid solvent to form liquid solutions. In this chapter, most of the chemistry that we will discuss occurs in liquid solutions where water is the solvent.
 3. Many alloys, ceramics, and polymer blends are **solid solutions**. Within a certain range, copper and zinc dissolve in each other and harden to give solid solutions called brass. Silver, gold, and copper form many different alloys with unique colors and appearances. Alloys and other solid solutions are important in the world of materials chemistry.
-

Section 8.4: Solubility

The maximum amount of a substance that can be dissolved in a given volume of solvent is called **solubility**. Often, the solubility in water is expressed in gram/100 mL. A solution that has not reached its maximum solubility is called an unsaturated solution. This means that more solute could still be added to the solvent and dissolving would still occur.

A solution that has reached the maximum solubility is called a **saturated solution**. If more solute is added at this point, it will not dissolve into the solution. Instead it will remain precipitated as a solid at the bottom of the solution. Thus, one can often tell that a solution is saturated if extra solute is present (this can exist as another phase, such as gas, liquid, or solid). In a saturated solution there is no net change in the amount of solute dissolved, but the system is by no means static. In fact, the solute is constantly being dissolved and deposited at an equal rate. Such a phenomenon is called **equilibrium**. For example:



In special circumstances, a solution may be **supersaturated**. Supersaturated solutions are solutions that have dissolved solute beyond the normal saturation point. Usually a condition such as increased temperature or pressure is required to create a supersaturated solution. For example, sodium acetate has a very high solubility at 270 K. When cooled, such a solution stays dissolved in what is called a **meta-stable state**. However, when a **seeding** crystal is added to the solution, the extra solute will rapidly solidify. During the crystallization process, heat is evolved, and the solution becomes warm. Common hand warmers use this chemical process to generate heat.

So how can we predict the solubility of a substance?

One useful classification of materials is polarity. As you read about covalent and ionic compounds in Chapters 3 and 4, you learned that ionic compounds have the highest polarity forming full cations and anions within each molecule as electrons are donated from one atom to another. You also learned that covalent bonds could be polar or nonpolar in nature depending on whether or not the atoms involved in the bond share the electrons unequally or equally, respectively. Recall that the electronegativity difference

can be used to determine the polarity of a substance. Typically an ionic bond has an electronegativity difference of 1.8 or above, whereas a polar covalent bond is between 0.4 to 1.8, and a nonpolar covalent bond is 0.4 or below.

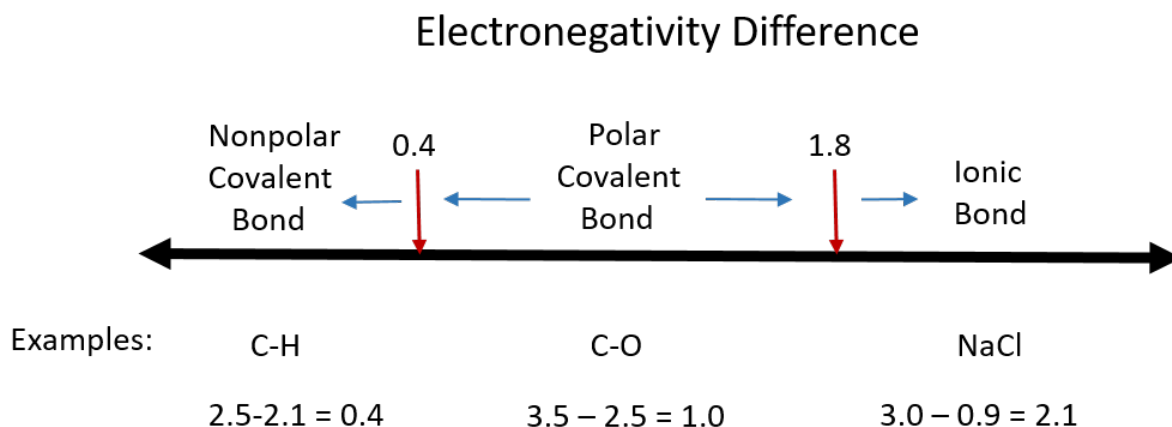

Figure 8.6 Electronegativity Difference Diagram. The diagram above is a guide for discerning what type of bond forms between two different atoms. By taking the difference between the electronegativity values for each of the atoms involved in the bond, the bond type and polarity can be predicted. Note that full ionic character is rarely reached, however when metals and nonmetals form bonds, they are named using the rules for ionic bonding.

Substances with zero or low electronegativity difference such as H_2 , O_2 , N_2 , CH_4 , CCl_4 are **nonpolar compounds**, whereas H_2O , NH_3 , CH_3OH , NO , CO , HCl , H_2S , PH_3 higher electronegativity difference are **polar compounds**. Typically compounds that have similar polarity are soluble in one another. This can be described by the rule:

Like Dissolves Like.

This means that substances must have similar intermolecular forces to form solutions. When a soluble solute is introduced into a solvent, the particles of solute can interact with the particles of solvent. In the case of a solid or liquid solute, the interactions between the solute particles and the solvent particles are so strong that the individual solute particles separate from each other and, surrounded by solvent molecules, enter the solution. (Gaseous solutes already have their constituent particles separated, but the concept of being surrounded by solvent particles still applies.) This process is called solvation and is

illustrated in Figure 7.2. When the solvent is water, the word hydration, rather than solvation, is used.

In general polar solvents dissolve polar solutes whereas nonpolar solvents will dissolve nonpolar solutes. Overall, the solution process depends on the strength of the attraction between the solute particles and the solvent particles. For example, water is a highly polar solvent that is capable of dissolving many ionic salts. Figure 8.7 shows the solution process, where water act as the solvent to dissolve the crystalline salt, sodium chloride (NaCl). Note that when ionic compounds dissolve in a solvent they break apart into free floating ions in solution. This enables the compound to interact with the solvent. In the case of water dissolving sodium chloride, the sodium ion is attracted to the partial negative charge of the oxygen atom in the water molecule, whereas the chloride ion is attracted to the partial positive hydrogen atoms.

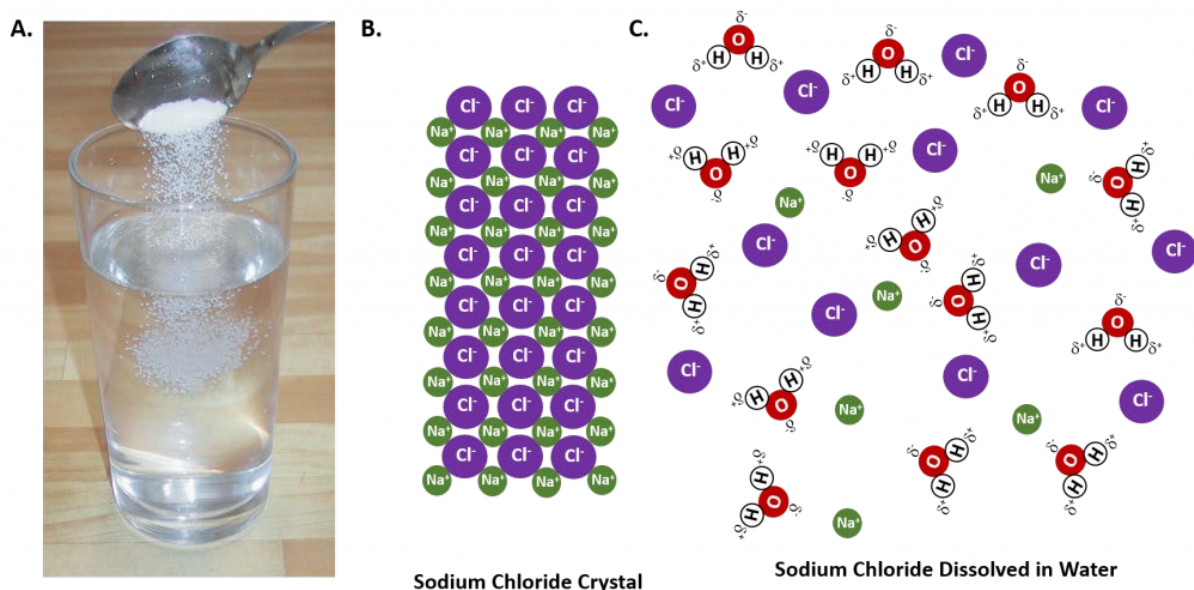

Figure 8.7: The Process of Dissolving. When an ionic salt, such as sodium chloride, shown in (A), comes into contact with water, the water molecules dissociate the ion molecules of the sodium chloride into their ionic state, shown as a molecular model in (B) the solid crystalline lattice of sodium chloride, and (C) the sodium chloride dissolved in the water solvent. (Photo of sodium chloride provided by [Chris 73](#)).

Many ionic compounds are soluble in water, however, not all ionic compounds are soluble. Ionic compounds that are soluble in water exist in their ionic state within the solution. You will notice in Figure 7.2 that the sodium chloride breaks apart into the

sodium ion and the chloride ion as it dissolves and interacts with the water molecules. For ionic compounds that are not soluble in water, the ions are so strongly attracted to one another that they cannot be broken apart by the partial charges of the water molecules.

The dissociation of soluble ionic compounds gives solutions of these compounds an interesting property: they conduct electricity. Because of this property, soluble ionic compounds are referred to as **electrolytes**. Many ionic compounds dissociate completely and are therefore called strong electrolytes. Sodium chloride is an example of a strong electrolyte. Some compounds dissolve but dissociate only partially, and solutions of such solutes may conduct electricity only weakly. These solutes are called weak electrolytes. Acetic acid (CH_3COOH), the compound in vinegar, is a weak electrolyte. Solute that dissolve into individual neutral molecules without dissociation do not impart additional electrical conductivity to their solutions and are called **nonelectrolytes**. Polar covalent compounds, such as table sugar ($\text{C}_{12}\text{H}_{22}\text{O}_{11}$), are good examples of nonelectrolytes.

The term electrolyte is used in medicine to mean any of the important ions that are dissolved in aqueous solution in the body. Important physiological electrolytes include Na^+ , K^+ , Ca^{2+} , Mg^{2+} , and Cl^- . Sports drinks such as Gatoraid have combinations of these key electrolytes, to help replenish electrolyte loss following a hard workout.

Similarly, solutions can also be made by mixing two compatible liquids together. The liquid in the lower concentration is termed the **solute**, and the one in higher concentration the solvent. For example, grain alcohol ($\text{CH}_3\text{CH}_2\text{OH}$) is a polar covalent molecule that can mix with water. When two similar solutions are placed together and are able to mix into a solution, they are said to be miscible. Liquids that do not share similar characteristics and cannot mix together, on the other hand, are termed immiscible. For example, the oils found in olive oil, such as oleic acid ($\text{C}_{18}\text{H}_{34}\text{O}_2$) have mainly nonpolar covalent bonds which do not have intermolecular forces that are strong enough to break the hydrogen bonding between the water molecules. Thus, water and oil do not mix and are said to be immiscible.

Other factor such as temperature and pressure also affects the solubility of a solvent. Thus, in specifying solubility, one should also be aware of these other factors.

Section 8.5: Solution Concentration

In chemistry, **concentration** is defined as the abundance of a constituent divided by the total volume of a mixture. All of us have a qualitative idea of what is meant by

concentration. Anyone who has made instant coffee or lemonade knows that too much powder gives a strongly flavored, highly concentrated drink, whereas too little results in a dilute solution that may be hard to distinguish from water. Quantitatively, the concentration of a solution describes the quantity of a solute that is contained in a particular quantity of that solution. Knowing the concentration of solutes is important in controlling the stoichiometry of reactants for reactions that occur in solution, and are critical for many aspects of our lives, from measuring the correct dose of medicine to detecting chemical pollutants like lead and arsenic. Chemists use many different ways to define concentrations. In this section, we will cover the most common ways of presenting solution concentration. These include: Molarity and Parts Per Solutions.

8.5.1 Molarity

The most common unit of concentration is molarity, which is also the most useful for calculations involving the stoichiometry of reactions in solution. The molarity (**M**) of a solution is the number of moles of solute present in exactly 1 L of solution.

$$\text{Molarity} = \frac{\text{moles solute}}{1 \text{ L of solution}}$$

OR

$$M = \frac{\text{mol}}{\text{L}}$$

The units of molarity are therefore moles per liter of solution (mol/L), abbreviated as M. Note that the volume indicated is the total volume of the solution and includes both the solute and the solvent. For example, an aqueous solution that contains 1 mol (342 g) of sucrose in enough water to give a final volume of 1.00 L has a sucrose concentration of 1.00 mol/L or 1.00 M. In chemical notation, square brackets around the name or formula of the solute represent the concentration of a solute. So

$$[\text{sucrose}] = 1.00 \text{ M}$$

is read as “the concentration of sucrose is 1.00 molar.” The equation above can be used to calculate how much solute is required to make any amount of a desired solution.

Example Problem:

Calculate the number of moles of sodium hydroxide (NaOH) needed to make 2.50 L of 0.100 M NaOH.

Given: (1) identity of solute = NaOH, (2) volume = 2.50 L, and (3) molarity of solution = 0.100 mol/L (Note: when calculating problems always write out the units of molarity as mol/L, rather than M. This will allow you to cancel out your units when doing the calculation.)

Asked for: amount of solute in moles

Strategy: (1) Rearrange the equation above to solve for the desired unit, in this case for moles. (2) Double check all the units in the equation and make sure they match. Perform any conversions that are needed so that the units match. (3) Fill in values appropriately and do the math.

Solution:

(1) Rearrange the equation above to solve for moles.

$$M = \frac{\text{mol}}{\text{L}} \quad \longrightarrow \quad \text{mol} = M \times L$$

(2) Double check all the units in the equation and make sure they match.

The given values for this equation are the volume 2.50 L and the molarity 0.100 mol/L. The volume units for both of these numbers are in Liters (L) and thus, match. Therefore, no conversions need to be made.

(3) Fill in values appropriately and do the math.

$$\text{mol} = M \times L$$

Fill in values and units

$$? \text{ mol of NaOH} = \frac{0.100 \text{ mol}}{\text{L}} \times 2.50 \text{ L}$$

Cancel Units and Calculate

$$? \text{ mol of NaOH} = \frac{0.100 \text{ mol}}{\cancel{\text{L}}} \times 2.50 \cancel{\text{L}}$$

Write out correct answer to correct number of Significant Figures (3 for this problem)

$$? \text{ mol of NaOH} = 0.250 \text{ mol of NaOH}$$



Double Check Units and Make sure they are correct!

Preparation of Solutions

Note that in the example above, we still don't have enough information to actually make the solution in the laboratory. There is no piece of equipment that can measure out the moles of a substance. For this, we need to convert the number of moles of the sample into the number of grams represented by that number. We can then easily use a balance to weigh the amount of substance needed for the solution. For the example above:

1. Calculate the Formula Mass of NaOH

$$\text{Na} = 22.990$$

$$\text{O} = 15.999$$

$$\text{H} = 1.008$$

$$= 22.990 + 15.999 + 1.008 = 39.997 \text{ g/mol of NaOH}$$

2. Convert moles of NaOH to grams of NaOH

$$0.250 \text{ mol of NaOH} \times \frac{39.997 \text{ g NaOH}}{1 \text{ mol NaOH}} = 9.9925 \text{ g}$$

Round to 3 sig figs = 10.0 g NaOH needed to make 2.50 L
of a 0.100 M solutions

To actually make the solution, it is typical to dissolve the solute in a small amount of the solvent and then once the solute is dissolved, the final volume can be brought up to 2.50 L. If you were to add 10 g of NaOH directly to 2.50 L, the final volume would be larger than 2.50 L and the solution concentration would be less than 0.100 M. Remember that the final volume must include both the solute and the solvent.

Figure 8.8 illustrates the procedure for making a solution of cobalt(II) chloride dihydrate in ethanol. Note that the volume of the **solvent** is not specified. Since the solute occupies space in the solution, the volume of the solvent needed is **less** than the desired total volume of solution.

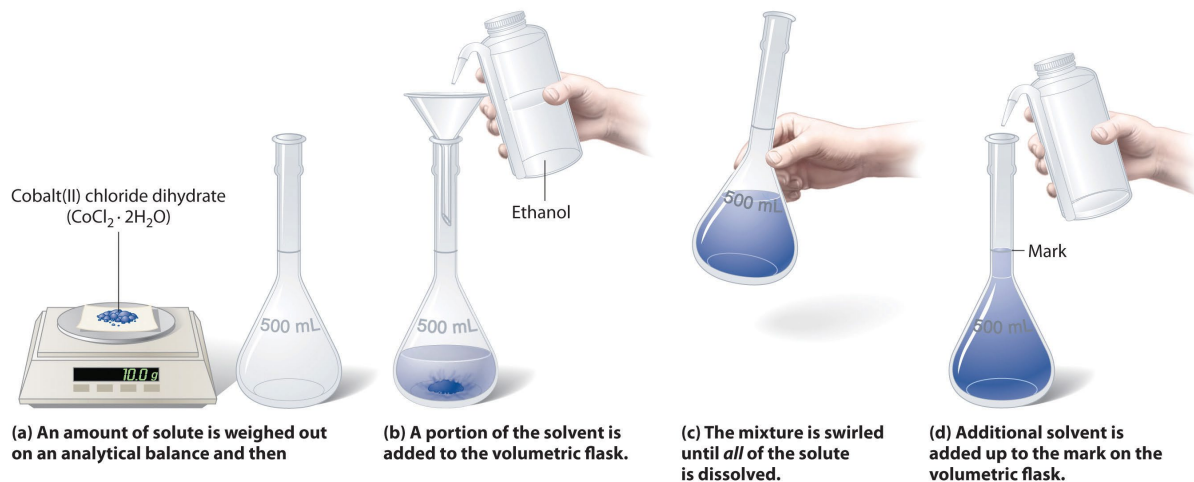

Figure 8.8: Preparation of a Solution of Known Concentration Using a Solid Solute.

To make a solution, start by addition a portion of the solvent to the flask. Next, weigh out the appropriate amount of solute and slowly add it to the solvent. Once it is dissolved in the solvent, the volume of the solution can be brought up to the final solution volume. For the volumetric flask shown, this is indicated by the black line in the neck of the flask. In this case, it indicates 500 mL of solution. Volumetric flasks exist in many different sizes to accommodate different solution volumes. Graduated cylinders can also be used to accurately bring a solution to its final volume. Other glassware, including beakers and Erlenmeyer flasks are not accurate enough to make most solutions.

Example Molarity Calculation

The solution in Figure 7.8 contains 10.0 g of cobalt(II) chloride dihydrate, $\text{CoCl}_2 \cdot 2\text{H}_2\text{O}$, in enough ethanol to make exactly 500 mL of solution. What is the molar concentration of $\text{CoCl}_2 \cdot 2\text{H}_2\text{O}$?

Given: mass of solute and volume of solution

Asked for: concentration (M)

Strategy:

1. We know that Molarity equals moles/Liter

$$M = \frac{\text{mol}}{\text{L}}$$

2. To calculate Molarity, we need to express:

- the mass in the form of moles
- the volume in the form of Liters
- Plug both into the equation above and calculate

Solution:

1. Converting the mass into moles. We can use the molar mass to convert the grams of $\text{CoCl}_2 \cdot 2\text{H}_2\text{O}$ to moles.
 - The molar mass of $\text{CoCl}_2 \cdot 2\text{H}_2\text{O}$ is 165.87 g/mol (and includes the two water molecules as they are part of the crystal lattice structure of this solid hydrate!)

$$? \text{ mol of } \text{CoCl}_2 \cdot 2\text{H}_2\text{O} = 10.0 \cancel{\text{g}} \times \frac{1 \text{ mol}}{165.87 \cancel{\text{g}}} = 0.0603 \text{ moles}$$

Cancel Units and Calculate

2. Convert the volume into Liters

$$? \text{ Liters of Soln} = 500 \cancel{\text{mL}} \times \frac{1 \text{ L}}{1000 \cancel{\text{mL}}} = 0.500 \text{ L}$$

Cancel Units and Calculate

3. Plug values into the Molarity equation:

$$? \text{ Molarity of Soln} = \frac{0.0603 \text{ moles}}{0.500 \text{ mL}} = 0.121 \text{ mol/L}$$

Write out correct answer to correct number of Significant Figures (3 for this problem due to volumes and grams given)

8.5.2 Parts Per Solutions

In the consumer and industrial world, the most common method of expressing the concentration is based on the quantity of solute in a fixed quantity of solution. The "quantities" referred to here can be expressed in mass, in volume, or both (i.e., the *mass* of solute in a given *volume* of solution.) In order to distinguish among these possibilities, the abbreviations (m/m), (v/v) and (m/v) are used.

In most applied fields of Chemistry, (m/m) measure is often used, whereas in clinical chemistry, (m/v) is commonly used, with mass expressed in grams and volume in mL.

One of the more common ways to express such concentrations as "**parts per 100**", which we all know as "**percent**". "Cent" is the Latin-derived prefix relating to the number 100 (L. *centum*), as in *century* or *centennial*. It also denotes 1/100th (from L. *centesimus*) as in *centimeter* and the monetary unit *cent*. Percent solutions define the quantity of a solute that is dissolved in a quantity of solution multiplied by 100. Percent solutions can be expressed in terms of mass solute per mass solution (m/m%), or mass solute per volume of solution (m/v%), or volume of solute per volume of solution (v/v%). When making a percent solution, it is important to indicate what units are being used, so that others can also make the solution properly. Also, recall that the solution is the sum of both the solvent and the solute when you are performing percent calculations.

$$\text{Solution} = \text{Solute} + \text{Solvent}$$

Thus, the following equation can be used when calculating percent solutions:

General Equation for Percent Solutions

$$\% \text{ Solution} = \frac{\text{Amount of Solute}}{\text{Amount Solution}} \times 100$$

(Mass is expressed in grams, Volume is expressed in mL)

Example 1:

As an example, a 7.0% v/v solution of ethanol in water, would contain 7 mL of ethanol in a total of 100 mL of solution. How much water is in the solution?

In this problem, we know that the:

$$\text{Solution} = \text{Solute} + \text{Solvent}$$

Thus, we can fill in the values and then solve for the unknown.

$$100 \text{ mL} = 7 \text{ mL} + X \text{ mL of Solvent (in this case water)}$$

shifting the 7 over to the other side, we can see that:

$$100 \text{ mL} - 7 \text{ mL} = 93 \text{ mL H}_2\text{O}$$

Example 2

What is the (m/v)% of a solution if 24.0 g of sucrose is dissolved in a total solution of 243 mL?

$$\% \text{ Solution} = \frac{\text{Amount of Solute}}{\text{Amount Solution}} \times 100$$

(Mass is expressed in grams, Volume is expressed in mL)

Fill in the known values (double check the units!!):

$$\% \text{ Solution} = \frac{24.0 \text{ g sucrose}}{243 \text{ mL solution}} \times 100$$

Do the math:

$$\% \text{ Solution} = 9.8765 \%$$

Round to the correct number of significant figures (3 in this case):

$$\% \text{ Solution} = 9.88 \%$$

Example 3

How many grams of NaCl are required to make 625 mL of a 13.5% solution?

$$\% \text{ Solution} = \frac{\text{Amount of Solute}}{\text{Amount Solution}} \times 100$$

(Mass is expressed in grams, Volume is expressed in mL)

Fill in the known values (double check the units!!):

$$13.5 \% \text{ Solution} = \frac{X \text{ g NaCl}}{625 \text{ mL solution}} \times 100$$

Rearrange the equation to solve for the unknown value:

$$\frac{13.5 \text{ g}}{100 \text{ mL}} \times 625 \text{ mL solution} = X \text{ g NaCl}$$

Do the math:

$$84.375 \text{ g} = X \text{ g NaCl}$$

Round to the correct number of significant figures (3 in this case):

$$= 84.4 \text{ g NaCl would be needed}$$

For more dilute solutions, parts per million (10^6 ppm) and parts per billion (10^9 ; ppb) are used. These terms are widely employed to express the amounts of trace pollutants in the environment.

Like percentage ("part per hundred") units, ppm and ppb may be defined in terms of masses, volumes, or mixed mass-volume units. There are also ppm and ppb units defined with respect to numbers of atoms and molecules.

The mass-based definitions of ppm and ppb are given here:

$$\text{ppm} = \frac{\text{Mass of Solute}}{\text{Mass of Solution}} \times 10^6$$

$$\text{ppb} = \frac{\text{Mass of Solute}}{\text{Mass of Solution}} \times 10^9$$

Both ppm and ppb are convenient units for reporting the concentrations of pollutants and other trace contaminants in water. Concentrations of these contaminants are typically very low in treated and natural waters, and their levels cannot exceed relatively low concentration thresholds without causing adverse effects on health and wildlife. For example, the EPA has identified the maximum safe level of fluoride ion in tap water to be 4 ppm. Inline water filters are designed to reduce the concentration of fluoride and several other trace-level contaminants in tap water (Figure 8.9).



(a)



(b)

Figure 8.9. (a) In some areas, trace-level concentrations of contaminants can render unfiltered tap water unsafe for drinking and cooking. (b) Inline water filters reduce the concentration of solutes in tap water. (credit a: modification of work by Jenn Durfey; credit b: modification of work by "vastateparkstaff"/Wikimedia commons)

When reporting contaminants like lead in drinking water, ppm and ppb concentrations are often reported in mixed unit values of mass/volume. This can be very useful as it is easier for us to think about water in terms of its volume, rather than by its mass. In addition, the density of water is 1.0 g/mL or 1.0 mg/0.001 mL which makes the conversion between the two units easier. For example, if we find that there is lead contamination in water of 4 ppm, this would mean that there are:

$$4 \text{ ppm} = \frac{4 \text{ mg lead}}{1,000,000 \text{ mg solution}}$$

But this is hard for us to think about how much water that is!

Since the solution is mostly water, we can calculate the total solution based on the total amount of water (solvent) present, rather than the solvent + the solute, and there will only be negligible error in the total amount of solution present. This allows us to convert the water units from mass into volume, using the density of water as a conversion factor.

$$1,000,000 \text{ mg H}_2\text{O} \quad \times \quad \frac{0.001 \text{ mL}}{1 \text{ mg}} \quad = \quad 1,000 \text{ mL H}_2\text{O}$$

We know from our unit on the metric system that:

$$1,000 \text{ mL H}_2\text{O} = 1 \text{ L H}_2\text{O}$$

Such that:

$$1,000,000 \text{ mg H}_2\text{O} = 1 \text{ L H}_2\text{O}$$

Substituting this back into our original equation, we can see that:

$$4 \text{ ppm} = \frac{4 \text{ mg lead}}{1 \text{ L solution}}$$

Therefore, ppm is often given as:

$$\text{ppm} = \frac{\text{mg}}{\text{L}}$$

Similarly, ppb is 1,000 times more dilute and can be represented as:

$$\text{ppb} = \frac{\mu\text{g}}{\text{L}}$$

8.5.3 Equivalentents

Concentrations of ionic solutes are occasionally expressed in units called equivalentents (Eq). One equivalent equals 1 mol of positive or negative charge. Thus, 1 mol/L of $\text{Na}^+(\text{aq})$ is also 1 Eq/L because sodium has a 1+ charge. A 1 mol/L solution of $\text{Ca}^{2+}(\text{aq})$ ions has a concentration of 2 Eq/L because calcium has a 2+ charge. Dilute solutions may be expressed in milliequivalentents (mEq)—for example, human blood plasma has a total concentration of about 150 mEq/L.

In a more formal definition, the **equivalent** is the amount of a substance needed to do one of the following:

- react with or supply one mole of hydrogen ions (H^+) in an acid–base reaction
- react with or supply one mole of electrons in a redox reaction.

By this definition, an *equivalent* is the number of moles of an ion in a solution, multiplied by the valence of that ion. If 1 mol of NaCl and 1 mol of CaCl_2 dissolve in a solution, there is 1 equiv Na, 2 equiv Ca, and 3 equiv Cl in that solution. (The valence of calcium is 2, so for that ion you have 1 mole and 2 equivalentents.)

Section 8.6: Dilutions

A solution of a desired concentration can also be prepared by diluting a small volume of a more concentrated solution with additional solvent. A stock solution, which is a prepared solution of known concentration, is often used for this purpose. Diluting a stock solution is preferred when making solutions of very weak concentrations, because the alternative

method, weighing out tiny amounts of solute, can be difficult to carry out with a high degree of accuracy. Dilution is also used to prepare solutions from substances that are sold as concentrated aqueous solutions, such as strong acids. The procedure for preparing a solution of known concentration from a stock solution is shown in Figure 8.10. It requires calculating the amount of solute desired in the final volume of the more dilute solution and then calculating the volume of the stock solution that contains this amount of solute. Remember that diluting a given quantity of stock solution with solvent does **not** change the amount of solute present, only the volume of the solution is changing. The relationship between the volume and concentration of the stock solution and the volume and concentration of the desired diluted solution can therefore be expressed mathematically as:

$$(M_s)(V_s) = (M_d)(V_d)$$

Where M_s is the concentration of the stock solution, V_s is the volume of the stock solution, M_d is the concentration of the diluted solution, and V_d is the volume of the diluted solution.

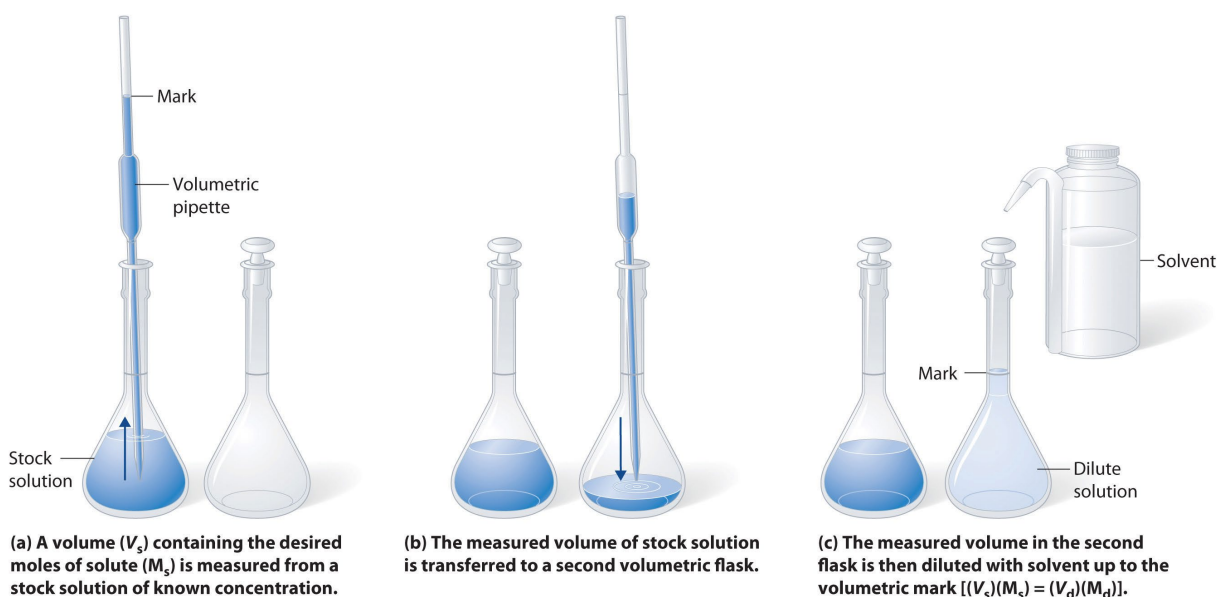

Figure 8.10 Preparation of a Solution of Known Concentration by Diluting a Stock Solution. (a) A volume (V_s) containing the desired amount of solute (M_s) is measured from a stock solution of known concentration. (b) The measured volume of stock solution is transferred to a second volumetric flask. (c) The measured volume in the second flask is then diluted with solvent up to the volumetric mark [$(V_s)(M_s) = (V_d)(M_d)$].

Example of Dilution Calculations

What volume of a 3.00 M glucose stock solution is necessary to prepare 2500 mL of 0.400 M solution?

Given: volume and molarity of dilute solution, and molarity of stock solution

Asked for: volume of stock solution

Strategy and Solution:

For Dilution problems, as long as you know 3 of the variables, you can solve for the 4th variable.

1. Start by rearranging the equation to solve for the variable that you want to find. In this case, you want to find the volume of the stock solution, V_s

$$V_s = \frac{(M_d)(V_d)}{(M_s)}$$

2. Next, check to make sure that like terms have the same units. For example, M_d and M_s are both concentrations, thus, to be able to perform the calculations, they should be in the same unit (in this case they are both listed in Molarity). If the concentrations were different, say one was given in Molarity and the other in percent or one was in Molarity and the other was in Millimolarity, one of the terms would need to be converted so that they match. That way, the units will cancel out and leave you with units of volume, in this case.

3. Finally, fill in the equation with known values and calculate the final answer.

$$V_s = \frac{(0.400 \cancel{M})(2500 \text{ mL})}{(3.00\cancel{M})} = 333 \text{ mL of Stock Solution}$$

*Write out correct answer to correct number of Significant Figures
(3 for this problem due to concentrations)*

Note that if 333mL of stock solution is needed, that you can also calculate the amount of solvent needed to make the final dilution. (Total volume - volume of stock solution = volume of solvent needed for the final dilution. In this case 2,500 mL - 333 mL = 2,167 mL of water needed to make the final dilution (this should be done in a graduated cylinder or volumetric flask).

Section 8.7: Ion Concentrations in Solution

Thus far, we have been discussing the concentration of the overall solution in terms of total solute divided by the volume of the solution. Let's consider in more detail exactly what that means when considering ionic and covalent compounds. When ionic compounds dissolve in a solution, they break apart into their ionic state. Cations and anions associate with the polar water molecules. Recall that solutions that contain ions are called **electrolytes**, due to their ability to conduct electricity. For example, ammonium dichromate $(\text{NH}_4)_2\text{Cr}_2\text{O}_7$ is an ionic compound that contains two NH_4^+ ions and one $\text{Cr}_2\text{O}_7^{2-}$ ion per formula unit. Like other ionic compounds, it is a strong electrolyte that dissociates in aqueous solution to give hydrated NH_4^+ and $\text{Cr}_2\text{O}_7^{2-}$ ions. If we consider this this solution mathematically, we can see that for every ammonium dichromate molecule that dissolves, there will be three resulting ions that form (the two NH_4^+ ions and the one $\text{Cr}_2\text{O}_7^{2-}$ ion). This can also be thought of on a larger molar scale. When 1 mole of $(\text{NH}_4)_2\text{Cr}_2\text{O}_7$ is dissolved, it results in 3 moles of ions (1 mol of $\text{Cr}_2\text{O}_7^{2-}$ anions and 2 mol of NH_4^+ cations) within the solution (Figure 8.11). To discuss the relationship between the concentration of a solution and the resulting number of ions, the term **equivalents** is used.

One equivalent is defined as the amount of an ionic compound that provides 1 mole of electrical charge (+ or -). It is calculated by dividing the molarity of the solution by the total charge created in the solution.

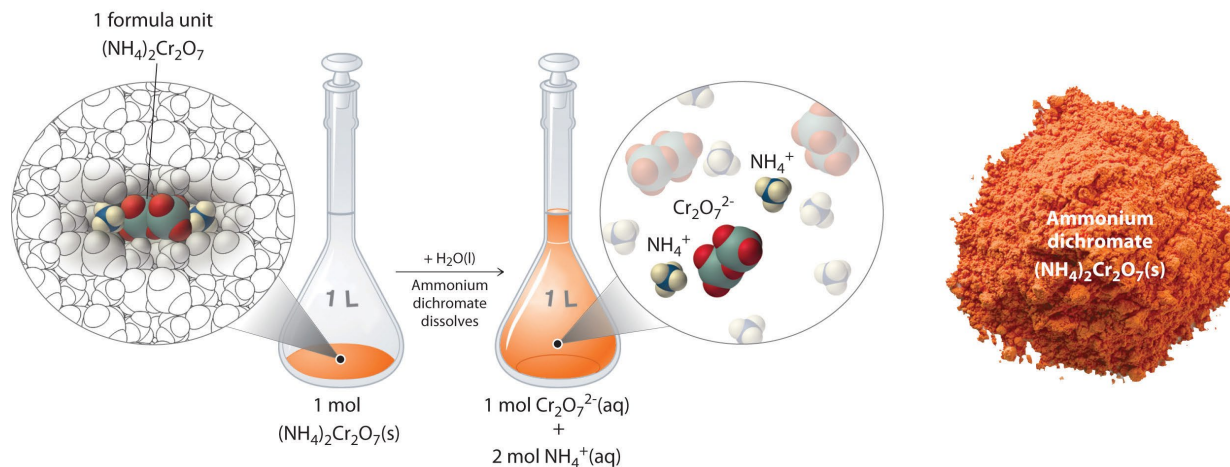

Figure 8.11 Dissolution of 1 mol of an Ionic Compound. Dissolving 1 mol of ammonium dichromate formula units in water produces 1 mol of $\text{Cr}_2\text{O}_7^{2-}$ anions and 2 mol of NH_4^+ cations. (Water molecules are omitted from a molecular view of the solution for clarity.)

When we carry out a chemical reaction using a solution of a salt such as ammonium dichromate, we need to know the concentration of each ion present in the solution. If a solution contains 1.43 M $(\text{NH}_4)_2\text{Cr}_2\text{O}_7$, then the concentration of $\text{Cr}_2\text{O}_7^{2-}$ must also be 1.43 M because there is one $\text{Cr}_2\text{O}_7^{2-}$ ion per formula unit. However, there are two NH_4^+ ions per formula unit, so the concentration of NH_4^+ ions is $2 \times 1.43 \text{ M} = 2.86 \text{ M}$. Because each formula unit of $(\text{NH}_4)_2\text{Cr}_2\text{O}_7$ produces **three** ions when dissolved in water ($2\text{NH}_4^+ + 1\text{Cr}_2\text{O}_7^{2-}$), the **total** concentration of ions in the solution is $3 \times 1.43 \text{ M} = 4.29 \text{ M}$. The equivalent value of $(\text{NH}_4)_2\text{Cr}_2\text{O}_7$ can then be calculated by dividing 1.43 M by 4.29 M, yielding 0.333 equivalents. Thus, for $(\text{NH}_4)_2\text{Cr}_2\text{O}_7$, dissolving 0.333 moles of the compound will yield 1 mole of ions in the solution.

Example 1

What are the concentrations of all ionic species derived from the solutes in these aqueous solutions?

1. 0.21 M NaOH
2. 3.7 M $(\text{CH}_3)\text{CHOH}$
3. 0.032 M $\text{In}(\text{NO}_3)_3$

Given: molarity

Asked for: concentrations

Strategy:

A Classify each compound as either a strong electrolyte or a nonelectrolyte.

B If the compound is a nonelectrolyte, its concentration is the same as the molarity of the solution. If the compound is a strong electrolyte, determine the number of each ion contained in one formula unit. Find the concentration of each species by multiplying the number of each ion by the molarity of the solution.

Solution:

1. 0.21 M NaOH

A Sodium hydroxide is an ionic compound that is a strong electrolyte (and a strong base) in aqueous solution:

B Because each formula unit of NaOH produces one Na^+ ion and one OH^- ion, the concentration of each ion is the same as the concentration of NaOH: $[\text{Na}^+] = 0.21 \text{ M}$ and $[\text{OH}^-] = 0.21$

2. 3.7 M $(\text{CH}_3)_2\text{CHOH}$

A The formula $(\text{CH}_3)_2\text{CHOH}$ represents 2-propanol (isopropyl alcohol) and contains the $-\text{OH}$ group, so it is an alcohol. Recall from [Section 4.1 "Aqueous Solutions"](#) that alcohols are covalent compounds that dissolve in water to give solutions of neutral molecules. Thus alcohols are nonelectrolytes

B The only solute species in solution is therefore $(\text{CH}_3)_2\text{CHOH}$ molecules, so $[(\text{CH}_3)_2\text{CHOH}] = 3.7 \text{ M}$

3. 0.032 M $\text{In}(\text{NO}_3)_3$

A Indium nitrate is an ionic compound that contains In^{3+} ions and NO_3^- ions, so we expect it to behave like a strong electrolyte in aqueous solution

B One formula unit of $\text{In}(\text{NO}_3)_3$ produces one In^{3+} ion and three NO_3^- ions, so a 0.032 M $\text{In}(\text{NO}_3)_3$ solution contains 0.032 M In^{3+} and $3 \times 0.032 \text{ M} = 0.096 \text{ M}$ NO_3^- —that is, $[\text{In}^{3+}] = 0.032 \text{ M}$ and $[\text{NO}_3^-] = 0.096 \text{ M}$

Section 8.8: Movement of Molecules Across the Membrane

One of the great wonders of the cell membrane is its ability to regulate the concentration of substances inside the cell. These substances include ions such as Ca^{++} , Na^+ , K^+ , and Cl^- ; nutrients including sugars, fatty acids, and amino acids; and waste products, particularly carbon dioxide (CO_2), which must leave the cell.

The membrane's lipid bilayer structure provides the first level of control. The phospholipids are tightly packed together, and the membrane has a hydrophobic interior. This structure causes the membrane to be selectively permeable. A membrane that has **selective permeability** allows only substances meeting certain criteria to pass through it unaided. In the case of the cell membrane, only relatively small, nonpolar materials can move through the lipid bilayer (remember, the lipid tails of the membrane are nonpolar). Some examples of these are other lipids, oxygen and carbon dioxide gases, and alcohol. However, water-soluble materials—like glucose, amino acids, and electrolytes—need some assistance to cross the membrane because they are repelled by the hydrophobic tails of the phospholipid bilayer. All substances that move through the membrane do so by one of two general methods, which are categorized based on whether or not energy is required. **Passive transport** is the movement of substances across the membrane without the expenditure of cellular energy. In contrast, **active transport** is the movement of substances across the membrane using energy from adenosine triphosphate (ATP). You have seen examples of these types of transport mechanisms in Chapter 4, where we learned about the generation of an action potential within a neuron.

Passive Transport

In order to understand **how** substances move passively across a cell membrane, it is necessary to understand concentration gradients and diffusion. A **concentration gradient** is the difference in concentration of a substance across a space. Molecules (or ions) will spread/diffuse from where they are more concentrated to where they are less concentrated until they are equally distributed in that space. (When molecules move in this way, they are said to move **down** their concentration gradient.) **Diffusion** is the movement of particles from an area of higher concentration to an area of lower concentration. A couple of common examples will help to illustrate this concept. Imagine being inside a closed bathroom. If a bottle of perfume were sprayed, the scent molecules would naturally diffuse from the spot where they left the bottle to all corners of the bathroom, and this diffusion would go on until no more concentration gradient remains. Another example is a spoonful of sugar placed in a cup of tea. Eventually the sugar will diffuse throughout the tea until no concentration gradient remains. In both cases, if the

room is warmer or the tea hotter, diffusion occurs even faster as the molecules are bumping into each other and spreading out faster than at cooler temperatures. Having an internal body temperature around 98.6° F thus also aids in diffusion of particles within the body. Visit this [link](#) to see diffusion and how it is propelled by the kinetic energy of molecules in solution. Whenever a substance exists in greater concentration on one side of a semipermeable membrane, such as the cell membranes, any substance that can move down its concentration gradient across the membrane will do so. Consider substances that can easily diffuse through the lipid bilayer of the cell membrane, such as the gases oxygen (O₂) and CO₂. O₂ generally diffuses into cells because it is more concentrated outside of them, and CO₂ typically diffuses out of cells because it is more concentrated inside of them. Neither of these examples requires any energy on the part of the cell, and therefore they use passive transport to move across the membrane.

Before moving on, you need to review the gases that can diffuse across a cell membrane. Because cells rapidly use up oxygen during metabolism, there is typically a lower concentration of O₂ inside the cell than outside. As a result, oxygen will diffuse from the interstitial fluid directly through the lipid bilayer of the membrane and into the cytoplasm within the cell. On the other hand, because cells produce CO₂ as a byproduct of metabolism, CO₂ concentrations rise within the cytoplasm; therefore, CO₂ will move from the cell through the lipid bilayer and into the interstitial fluid, where its concentration is lower. This mechanism of molecules moving across a cell membrane from the side where they are more concentrated to the side where they are less concentrated is a form of passive transport called simple diffusion (Figure 8.12).

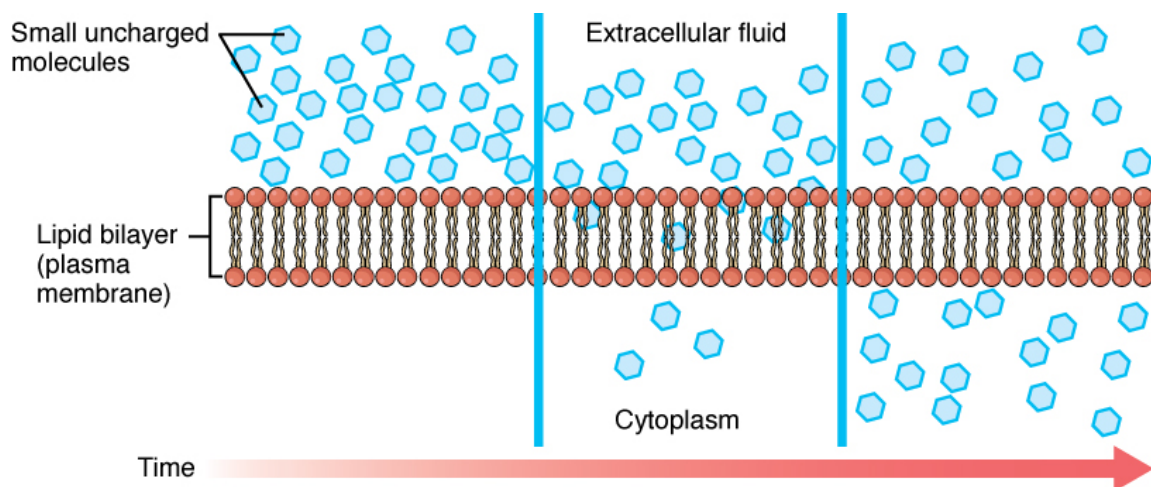

Figure 8.12. Simple Diffusion across the Cell (Plasma) Membrane. The structure of the lipid bilayer allows small, uncharged substances such as oxygen and carbon dioxide, and hydrophobic molecules such as lipids, to pass through the cell membrane, down their concentration gradient, by simple diffusion.

Large polar or ionic molecules, which are hydrophilic, cannot easily cross the phospholipid bilayer. Very small polar molecules, such as water, can cross via simple diffusion due to their small size. Charged atoms or molecules of any size cannot cross the cell membrane via simple diffusion as the charges are repelled by the hydrophobic tails in the interior of the phospholipid bilayer. Solutes dissolved in water on either side of the cell membrane will tend to diffuse down their concentration gradients, but because most substances cannot pass freely through the lipid bilayer of the cell membrane, their movement is restricted to protein channels and specialized transport mechanisms in the membrane. **Facilitated diffusion** is the diffusion process used for those substances that cannot cross the lipid bilayer due to their size, charge, and/or polarity (Figure 8.13). A common example of facilitated diffusion is the movement of glucose into the cell, where it is used to make ATP. Although glucose can be more concentrated outside of a cell, it cannot cross the lipid bilayer via simple diffusion because it is both large and polar. To resolve this, a specialized carrier protein called the glucose transporter will transfer glucose molecules into the cell to facilitate its inward diffusion.

As an example, even though sodium ions (Na^+) are highly concentrated outside of cells, these electrolytes are charged and cannot pass through the nonpolar lipid bilayer of the membrane. Their diffusion is facilitated by membrane proteins that form sodium channels (or "pores"), so that Na^+ ions can move down their concentration gradient from outside the cells to inside the cells. There are many other solutes that must undergo facilitated diffusion to move into a cell, such as amino acids, or to move out of a cell, such as wastes. Because facilitated diffusion is a passive process, it does not require energy expenditure by the cell.

Water also can move freely across the cell membrane of all cells, either through protein channels or by slipping between the lipid tails of the membrane itself. **Osmosis** is the diffusion of water through a semipermeable membrane (Figure 8.14).

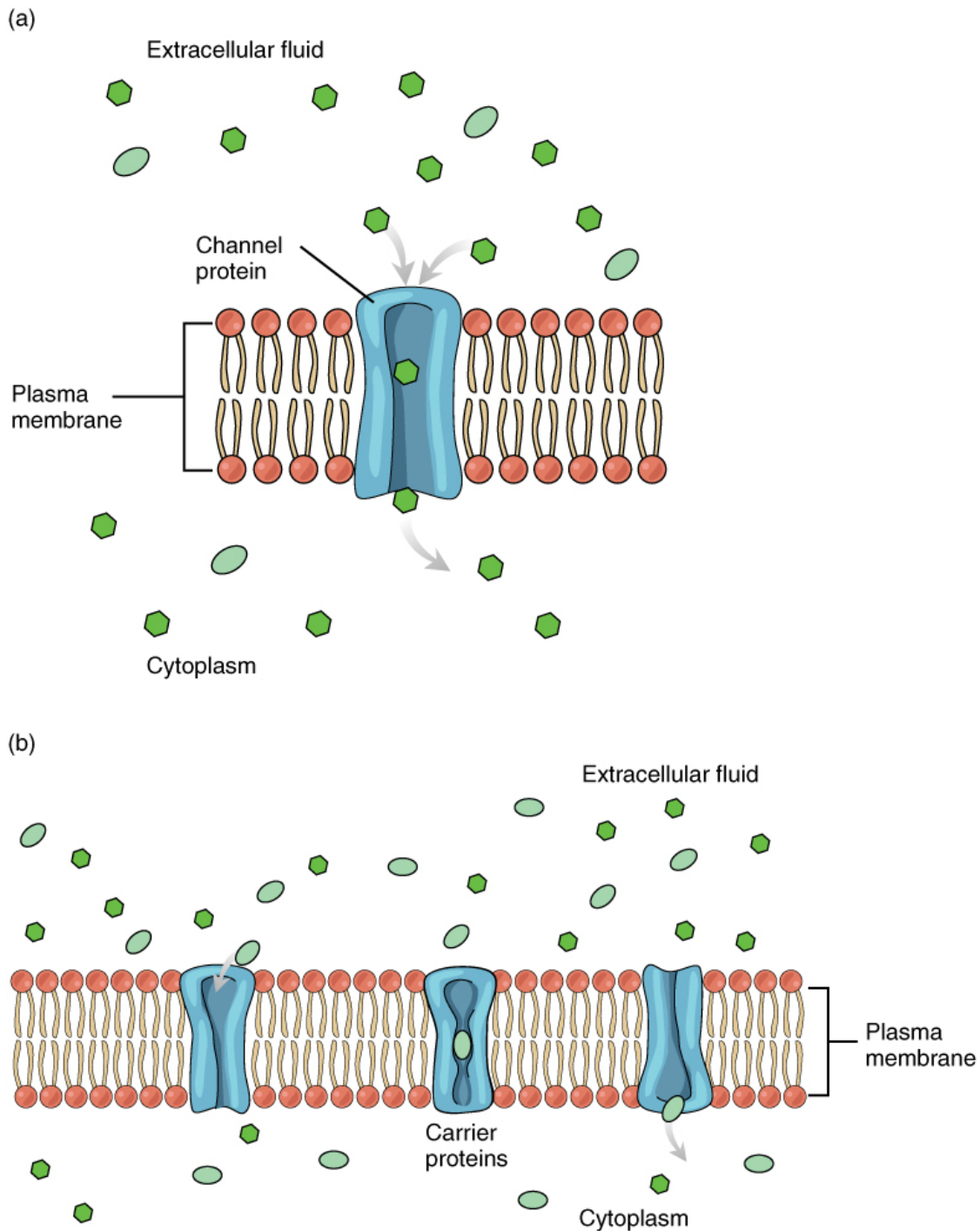

Figure 8.13. Facilitated Diffusion. (a) Facilitated diffusion of substances crossing the cell (plasma) membrane takes place with the help of proteins such as channel proteins and carrier proteins. Channel proteins are less selective than carrier proteins, and usually mildly discriminate between their cargo based on size and charge. (b) Carrier proteins are more selective, often only allowing one particular type of molecule to cross.

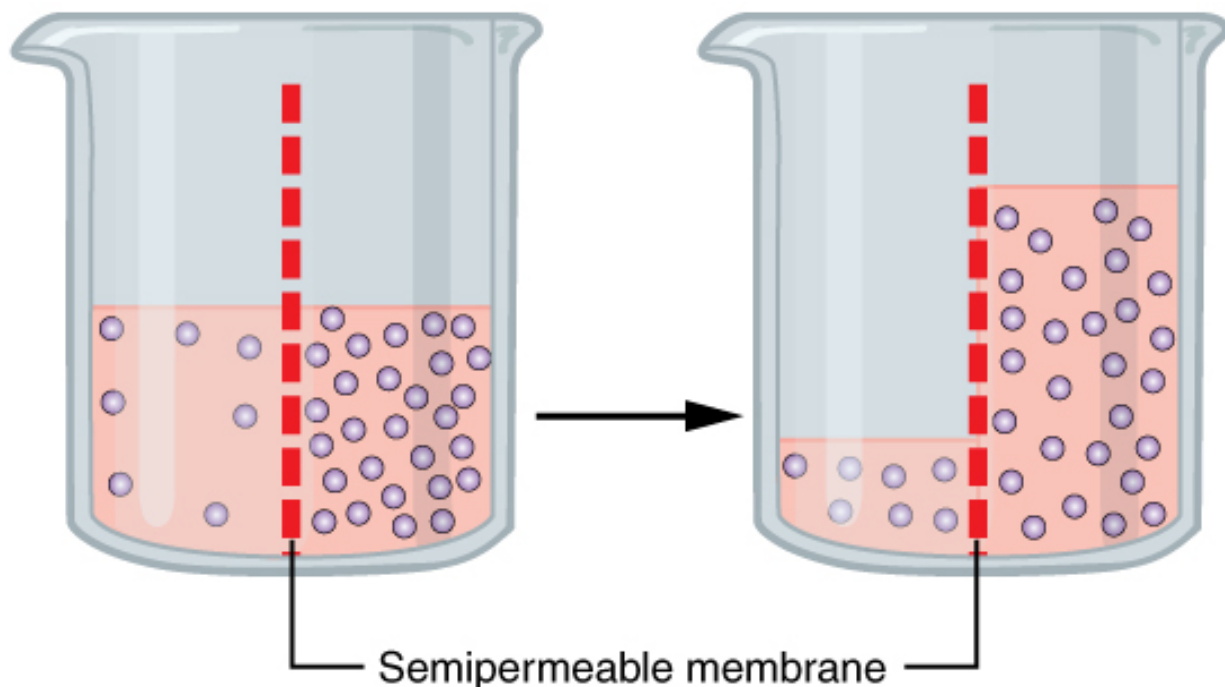

Figure 8.14. Osmosis. Osmosis is the diffusion of water through a semipermeable membrane down its concentration gradient. If a membrane is permeable to water, though not to a solute, water will equalize its own concentration by diffusing to the side of lower water concentration (and thus the side of higher solute concentration). In the beaker on the left, the solution on the right side of the membrane is hypertonic.

The movement of water molecules is not itself regulated by cells, so it is important that cells are exposed to an environment in which the concentration of solutes outside of the cells (in the extracellular fluid) is equal to the concentration of solutes inside the cells (in the cytoplasm). **Tonicity** is used to describe the variations of solute in a solution with the solute inside the cell. Three terms—hypotonic, isotonic, and hypertonic—are used to compare the relative solute concentration of a cell to that of the extracellular fluid surrounding the cells.

In a hypotonic **solution**, such as tap water, the extracellular fluid has a lower concentration of solutes than the fluid inside the cell, and water enters the cell. (Note that water is moving down its concentration gradient) If this occurs in an animal cell, the cell may burst, or lyse.

In a hypertonic solution (the prefix **hyper-** refers to the extracellular fluid having a higher concentration of solutes than the cell's cytoplasm), the fluid contains less water than the cell does. Because the cell has a lower concentration of solutes, the water will leave the cell. In effect, the solute is drawing the water out of the cell. This may cause an animal cell to shrivel, or crenate.

In an isotonic solution, the extracellular fluid has the same solute concentration as the cell. If the concentration of solutes of the cell matches that of the extracellular fluid, there will be no net movement of water into or out of the cell.

Blood cells in hypertonic, isotonic, and hypotonic solutions take on characteristic appearances as shown in Figure 8.15. A critical aspect of homeostasis in living things is to create an internal environment in which all of the body's cells are in an isotonic solution. Various organ systems, particularly the kidneys, work to maintain this homeostasis.

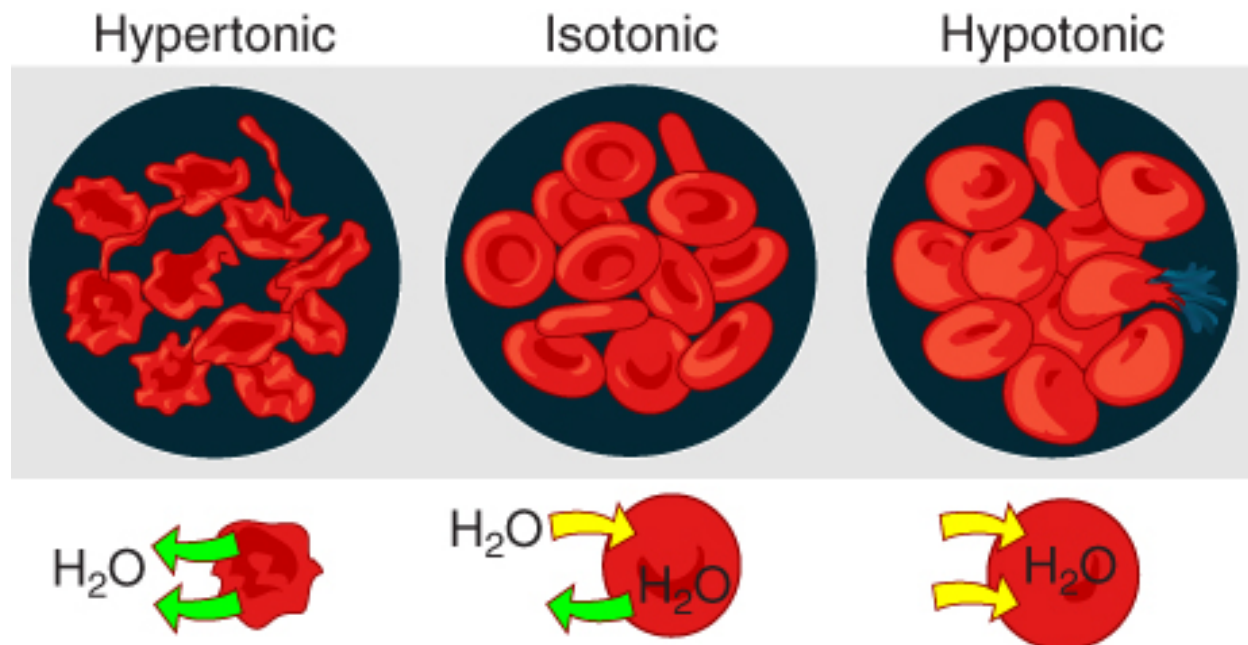

Figure 8.15. States of Tonicity. A hypertonic solution has a solute concentration higher than another solution. An isotonic solution has a solute concentration equal to another solution. A hypotonic solution has a solute concentration lower than another solution.

Some organisms, such as plants, fungi, bacteria, and some protists, have cell walls that surround the plasma membrane and prevent cell lysis. The plasma membrane can only expand to the limit of the cell wall, so the cell will not lyse. In fact, the cytoplasm in plants is always slightly hypertonic compared to the cellular environment, and water will always

enter a cell if water is available. This influx of water produces turgor pressure, which stiffens the cell walls of the plant (Figure 8.16). In nonwoody plants, turgor pressure supports the plant. If the plant cells become hypertonic, as occurs in drought or if a plant is not watered adequately, water will leave the cell. Plants lose turgor pressure in this condition and wilt.

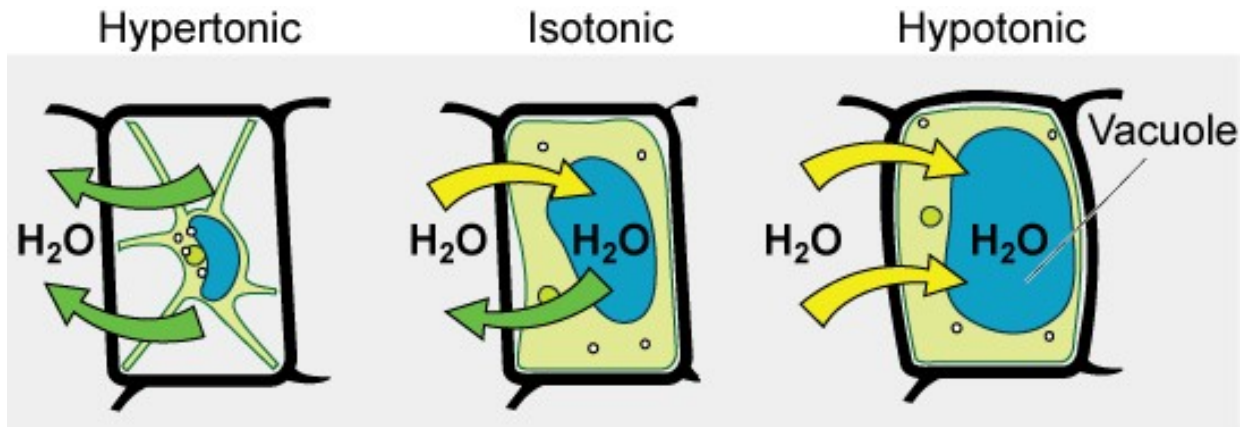

Figure 8.16 The turgor pressure within a plant cell depends on the tonicity of the surrounding solution.

Another mechanism besides diffusion to passively transport materials between compartments is filtration. Unlike diffusion of a substance from where it is more concentrated to less concentrated, filtration uses a hydrostatic pressure gradient that pushes the fluid—and the solutes within it—from a higher pressure area to a lower pressure area. Filtration is an extremely important process in the body. For example, the circulatory system uses filtration to move plasma and substances across the endothelial lining of capillaries and into surrounding tissues, supplying cells with the nutrients. Furthermore, filtration pressure in the kidneys provides the mechanism to remove wastes from the bloodstream.

Active Transport

For all of the transport methods described above, the cell expends no energy. Membrane proteins that aid in the passive transport of substances do so without the use of ATP. During **active transport**, ATP is required to move a substance across a membrane, often with the help of protein carriers, and usually against its concentration gradient.

One of the most common types of active transport involves proteins that serve as pumps. The word “pump” probably conjures up thoughts of using energy to pump up the tire of a bicycle or a basketball. Similarly, energy from ATP is required for these membrane proteins to transport substances—molecules or ions—across the membrane, usually against their concentration gradients (from an area of low concentration to an area of high concentration).

The **sodium-potassium pump**, which is also called Na^+/K^+ ATPase, transports sodium out of a cell while moving potassium into the cell. The Na^+/K^+ pump is an important ion pump found in the membranes of many types of cells. These pumps are particularly abundant in nerve cells, which are constantly pumping out sodium ions and pulling in potassium ions to maintain an electrical gradient across their cell membranes. An **electrical gradient** is a difference in electrical charge across a space. In the case of nerve cells, for example, the electrical gradient exists between the inside and outside of the cell, with the inside being negatively-charged (at around -70 mV) relative to the outside. The negative electrical gradient is maintained because each Na^+/K^+ pump moves three Na^+ ions out of the cell and two K^+ ions into the cell for each ATP molecule that is used (Figure 8.17). This process is so important for nerve cells that it accounts for the majority of their ATP usage.

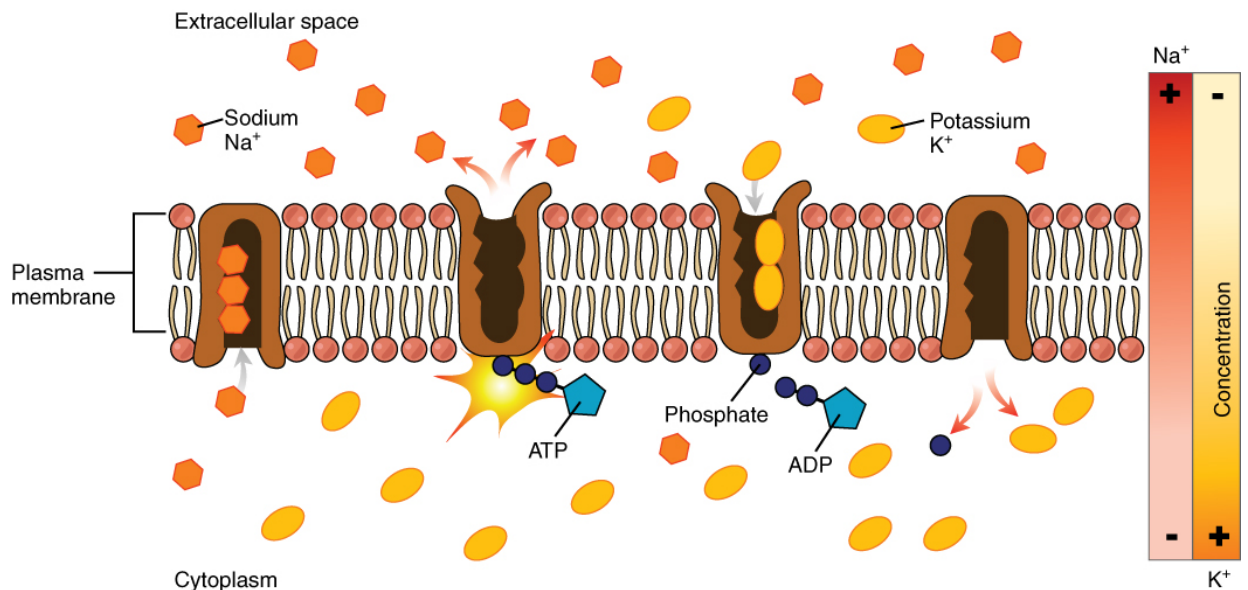

Figure 8.17. Sodium-Potassium Pump. The sodium-potassium pump is found in many cell (plasma) membranes. Powered by ATP, the pump moves sodium and potassium ions in opposite directions, each against its concentration gradient. In a single cycle of the pump, three sodium ions are extruded from and two potassium ions are imported into the cell.

Active transport pumps can also work together with other active or passive transport systems to move substances across the membrane. For example, the sodium-potassium pump maintains a high concentration of sodium ions outside of the cell. Therefore, if the cell needs sodium ions, all it has to do is open a passive sodium channel, as the concentration gradient of the sodium ions will drive them to diffuse into the cell. In this way, the action of an active transport pump (the sodium-potassium pump) powers the passive transport of sodium ions by creating a concentration gradient. When active transport powers the transport of another substance in this way, it is called secondary active transport.

Symporters are secondary active transporters that move two substances in the same direction. For example, the sodium-glucose symporter uses sodium ions to “pull” glucose molecules into the cell. Because cells store glucose for energy, glucose is typically at a higher concentration inside of the cell than outside. However, due to the action of the sodium-potassium pump, sodium ions will easily diffuse into the cell when the symporter is opened. The flood of sodium ions through the symporter provides the energy that allows glucose to move through the symporter and into the cell, against its concentration gradient.

Conversely, antiporters are secondary active transport systems that transport substances in opposite directions. For example, the sodium-hydrogen ion antiporter uses the energy from the inward flood of sodium ions to move hydrogen ions (H⁺) out of the cell. The sodium-hydrogen antiporter is used to maintain the pH of the cell’s interior.

Other forms of active transport do not involve membrane carriers. **Endocytosis** (bringing “into the cell”) is the process of a cell ingesting material by enveloping it in a portion of its cell membrane, and then pinching off that portion of membrane (Figure 8.18). Once pinched off, the portion of membrane and its contents becomes an independent, intracellular vesicle. A **vesicle** is a membranous sac—a spherical and hollow organelle bounded by a lipid bilayer membrane. Endocytosis often brings materials into the cell that must be broken down or digested. **Phagocytosis** (“cell eating”) is the endocytosis of large particles. Many immune cells engage in phagocytosis of invading pathogens. Like little Pac-men, their job is to patrol body tissues for unwanted matter, such as invading bacterial cells, phagocytize them, and digest them. In contrast to phagocytosis, **pinocytosis** (“cell drinking”) brings fluid containing dissolved substances into a cell through membrane vesicles.

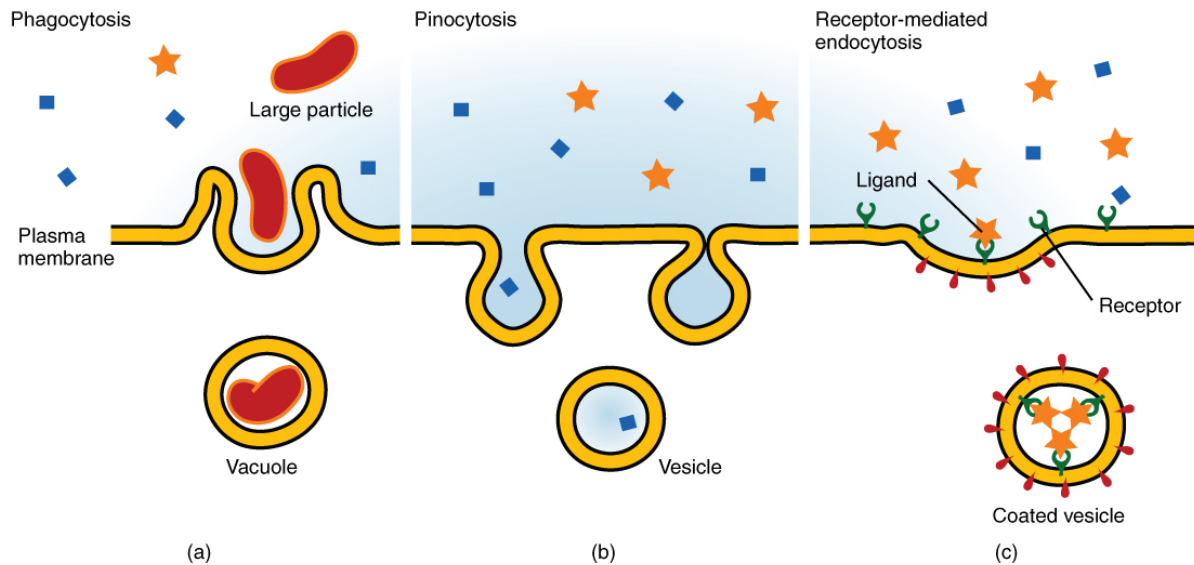

Figure 8.18. Three Forms of Endocytosis. Endocytosis is a form of active transport in which a cell envelopes extracellular materials using its cell membrane. (a) In phagocytosis, which is relatively nonselective, the cell takes in a large particle. (b) In pinocytosis, the cell takes in small particles in fluid. (c) In contrast, receptor-mediated endocytosis is quite selective. When external receptors bind a specific ligand, the cell responds by endocytosing the ligand.

Phagocytosis and pinocytosis take in large portions of extracellular material, and they are typically not highly selective in the substances they bring in. Cells regulate the endocytosis of specific substances via receptor-mediated endocytosis. **Receptor-mediated endocytosis** is endocytosis by a portion of the cell membrane that contains many receptors that are specific for a certain substance. Once the surface receptors have bound sufficient amounts of the specific substance (the receptor's ligand), the cell will endocytose the part of the cell membrane containing the receptor-ligand complexes. Iron, a required component of hemoglobin, is endocytosed by red blood cells in this way. Iron is bound to a protein called transferrin in the blood. Specific transferrin receptors on red blood cell surfaces bind the iron-transferrin molecules, and the cell endocytoses the receptor-ligand complexes.

In contrast with endocytosis, **exocytosis** (taking "out of the cell") is the process of a cell exporting material using vesicular transport (Figure 8.19). Many cells manufacture substances that must be secreted, like a factory manufacturing a product for export. These substances are typically packaged into membrane-bound vesicles within the cell. When the vesicle membrane fuses with the cell membrane, the vesicle releases its contents into

the interstitial fluid. The vesicle membrane then becomes part of the cell membrane. Cells of the stomach and pancreas produce and secrete digestive enzymes through exocytosis (Figure 8.20). Endocrine cells produce and secrete hormones that are sent throughout the body, and certain immune cells produce and secrete large amounts of histamine, a chemical important for immune responses.

Exocytosis

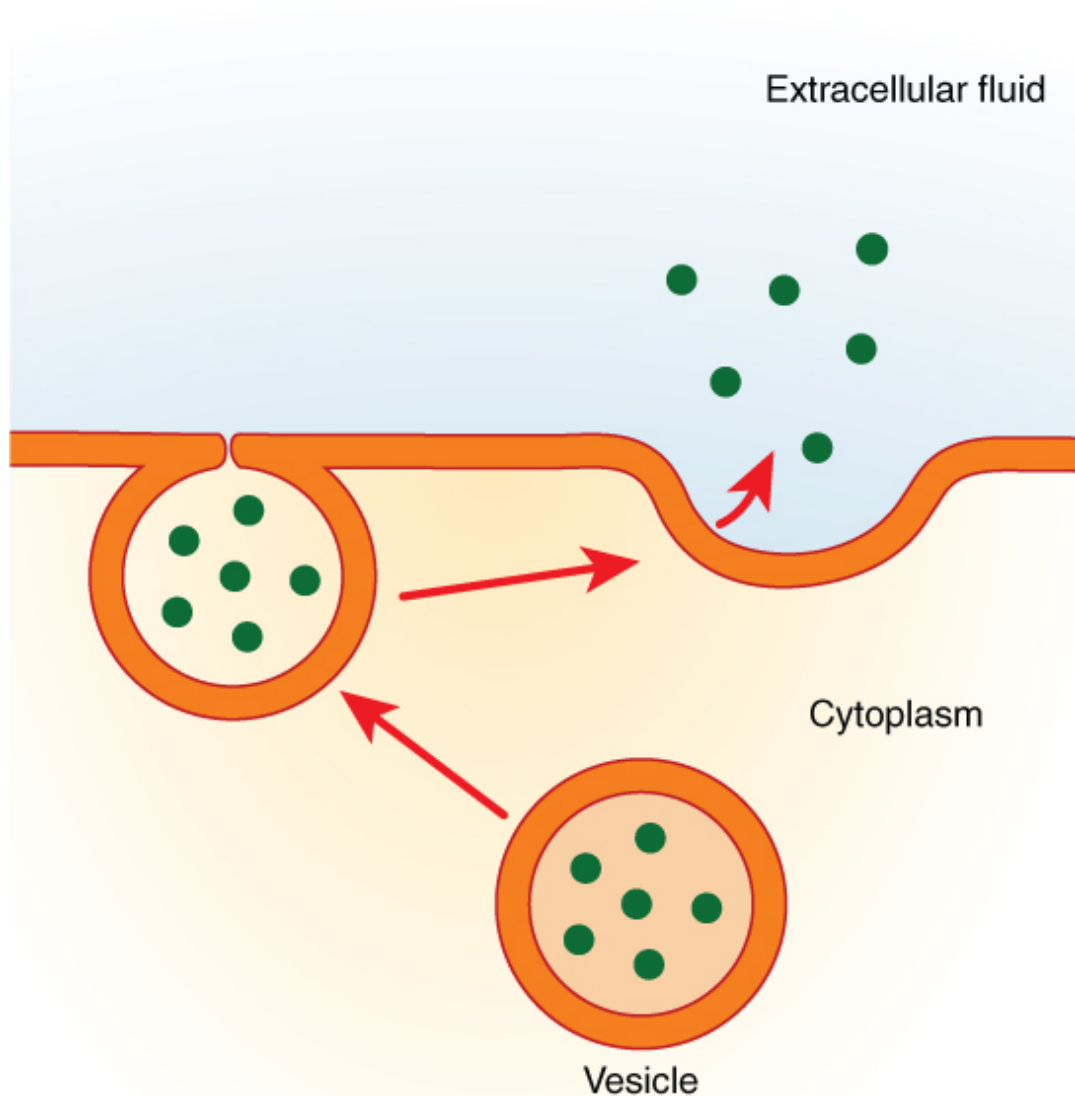

Figure 8.19. Exocytosis. Exocytosis is much like endocytosis in reverse. Material destined for export is packaged into a vesicle inside the cell. The membrane of the vesicle fuses with the cell membrane, and the contents are released into the extracellular space.

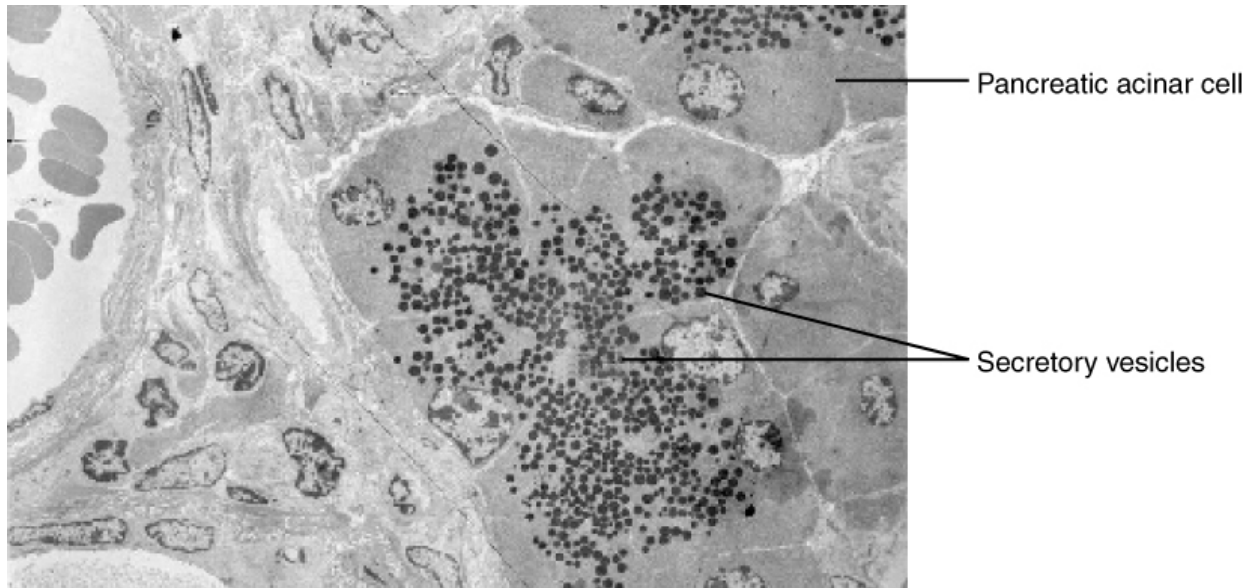

Figure 8.20. Pancreatic Cells' Enzyme Products. The pancreatic acinar cells produce and secrete many enzymes that digest food. The tiny black granules in this electron micrograph are secretory vesicles filled with enzymes that will be exported from the cells via exocytosis. LM \times 2900. (Micrograph provided by the Regents of University of Michigan Medical School \copyright 2012)

View the [University of Michigan WebScope](#) to explore the tissue sample in greater detail.

Section 8.9: Summary

To ensure that you understand the material in this chapter, you should review the meanings of the bold terms in the following summary and ask yourself how they relate to the topics in the chapter.

A **solution** is a homogeneous mixture. The major component is the **solvent**, while the minor component is the **solute**. Solutions can have any phase; for example, an **alloy** is a solid solution. Solutes are **soluble** or **insoluble**, meaning they dissolve or do not dissolve in a particular solvent. The terms **miscible** and **immiscible**, instead of soluble and insoluble, are used for liquid solutes and solvents. The statement **like dissolves like** is a useful guide to predicting whether a solute will dissolve in a given solvent.

Dissolving occurs by **solvation**, the process in which particles of a solvent surround the individual particles of a solute, separating them to make a solution. For water solutions,

the word **hydration** is used. If the solute is molecular, it dissolves into individual molecules. If the solute is ionic, the individual ions separate from each other, forming a solution that conducts electricity. Such solutions are called **electrolytes**. If the dissociation of ions is complete, the solution is a **strong electrolyte**. If the dissociation is only partial, the solution is a **weak electrolyte**. Solutions of molecules do not conduct electricity and are called **nonelectrolytes**.

The amount of solute in a solution is represented by the **concentration** of the solution. The maximum amount of solute that will dissolve in a given amount of solvent is called the **solubility** of the solute. Such solutions are **saturated**. Solutions that have less than the maximum amount are **unsaturated**. Most solutions are unsaturated, and there are various ways of stating their concentrations. **Mass/mass percent, volume/volume percent, and mass/volume percent** indicate the percentage of the overall solution that is solute. **Parts per million (ppm)** and **parts per billion (ppb)** are used to describe very small concentrations of a solute. **Molarity**, defined as the number of moles of solute per liter of solution, is a common concentration unit in the chemistry laboratory. **Equivalents** express concentrations in terms of moles of charge on ions. When a solution is diluted, we use the fact that the amount of solute remains constant to be able to determine the volume or concentration of the final diluted solution. Solutions of known concentration can be prepared either by dissolving a known mass of solute in a solvent and diluting to a desired final volume or by diluting the appropriate volume of a more concentrated solution (a **stock solution**) to the desired final volume.

The cell membrane provides a barrier around the cell, separating its internal components from the extracellular environment. It is composed of a phospholipid bilayer, with hydrophobic internal lipid "tails" and hydrophilic external phosphate "heads." Various membrane proteins are scattered throughout the bilayer, both inserted within it and attached to it peripherally. The cell membrane is selectively permeable, allowing only a limited number of materials to diffuse through its lipid bilayer. All materials that cross the membrane do so using passive (non energy-requiring) or active (energy-requiring) transport processes. During passive transport, materials move by simple diffusion or by facilitated diffusion through the membrane, down their concentration gradient. Water passes through the membrane in a diffusion process called osmosis. During active transport, energy is expended to assist material movement across the membrane in a direction against their concentration gradient. Active transport may take place with the help of protein pumps or through the use of vesicles.

Section 8.10: Practice Questions

Review Questions

1. Because they are embedded within the membrane, ion channels are examples of _____.
 - A. receptor proteins
 - B. integral proteins
 - C. peripheral proteins
 - D. glycoproteins
2. The diffusion of substances within a solution tends to move those substances _____ their _____ gradient.
 - A. up; electrical
 - B. up; electrochemical
 - C. down; pressure
 - D. down; concentration
3. Ion pumps and phagocytosis are both examples of _____.
 - A. endocytosis
 - B. passive transport
 - C. active transport
 - D. facilitated diffusion
4. Choose the answer that best completes the following analogy: Diffusion is to _____ as endocytosis is to _____.
 - A. filtration; phagocytosis
 - B. osmosis; pinocytosis
 - C. solutes; fluid
 - D. gradient; chemical energy

Critical Thinking Questions

1. What materials can easily diffuse through the lipid bilayer, and why?

2. Why is receptor-mediated endocytosis said to be more selective than phagocytosis or pinocytosis?

3. What do osmosis, diffusion, filtration, and the movement of ions away from like charge all have in common? In what way do they differ?

Key Takeaway

- Solution concentrations are typically expressed as molarity and can be prepared by dissolving a known mass of solute in a solvent or diluting a stock solution.

Conceptual Problems

1. Which of the representations best corresponds to a 1 M aqueous solution of each compound? Justify your answers.
 1. NH_3
 2. HF
 3. $\text{CH}_3\text{CH}_2\text{CH}_2\text{OH}$
 4. Na_2SO_4

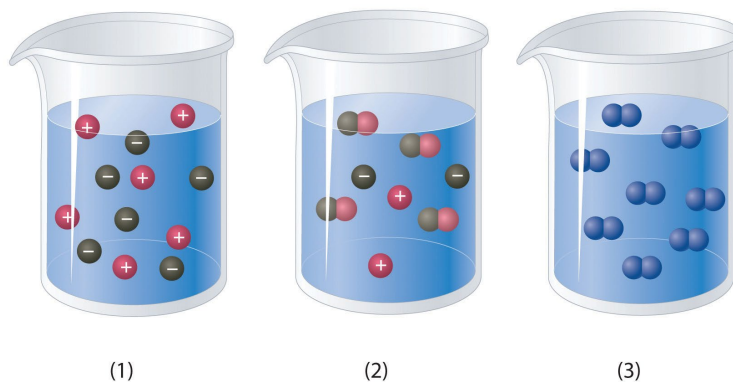

2. Which of the representations shown in Problem 1 best corresponds to a 1 M aqueous solution of each compound? Justify your answers.
 1. $\text{CH}_3\text{CO}_2\text{H}$
 2. NaCl
 3. Na_2S
 4. Na_3PO_4
 5. acetaldehyde
3. Would you expect a 1.0 M solution of CaCl_2 to be a better conductor of electricity than a 1.0 M solution of NaCl ? Why or why not?

- An alternative way to define the concentration of a solution is **molality**, abbreviated **m**. Molality is defined as the number of moles of solute in 1 kg of **solvent**. How is this different from molarity? Would you expect a 1 M solution of sucrose to be more or less concentrated than a 1 **m** solution of sucrose? Explain your answer.
- What are the advantages of using solutions for quantitative calculations?

Answers

- a) NH_3 is a weak base, which means that some of the molecules will accept a proton from water molecules causing them to dissociate into H^+ and -OH ions. The H^+ ion will associate with the NH_3 to form NH_4^+ . Thus this would look the most like beaker #2. b) HF is a weak acid even though F is strongly electronegative. This is because the H-F molecule can form strong hydrogen bonds with the water molecules and remain in a covalent bond that is harder to dissociate. Thus, beaker #2 is also a good choice for this molecule, as only some of the H-F will dissociate to H_3O^+ and F^- ions. c) $\text{CH}_3\text{CH}_2\text{CH}_2\text{OH}$ is a covalent compound and will not dissociate to any appreciable extent, thus, beaker #3 is the correct choice. d) Na_2SO_4 is a soluble ionic compound and will fully dissociate into ions looking most like beaker #1.
-
- Yes, because when CaCl_2 dissociates it will form 3 ions (1 Ca^{2+} and 2 Cl^- ions) whereas NaCl will only dissociate into 2 ions (Na^+ and a Cl^-) for each molecule. Thus, CaCl_2 will generate more ions per mole than 1 mole of NaCl and be a better conductor of electricity.
-
- If the amount of a substance required for a reaction is too small to be weighed accurately, the use of a solution of the substance, in which the solute is dispersed in a much larger mass of solvent, allows chemists to measure the quantity of the substance more accurately.

Numerical Problems

- Calculate the number of grams of solute in 1.000 L of each solution.
 - 0.2593 M NaBrO_3
 - 1.592 M KNO_3
 - 1.559 M acetic acid
 - 0.943 M potassium iodate

2. Calculate the number of grams of solute in 1.000 L of each solution.
 1. 0.1065 M BaI_2
 2. 1.135 M Na_2SO_4
 3. 1.428 M NH_4Br
 4. 0.889 M sodium acetate

3. If all solutions contain the same solute, which solution contains the greater mass of solute?
 1. 1.40 L of a 0.334 M solution or 1.10 L of a 0.420 M solution
 2. 25.0 mL of a 0.134 M solution or 10.0 mL of a 0.295 M solution
 3. 250 mL of a 0.489 M solution or 150 mL of a 0.769 M solution

4. Complete the following table for 500 mL of solution.

Compound	Mass (g)	Moles	Concentration (M)
calcium sulfate	4.86		
acetic acid		3.62	
hydrogen iodide dihydrate			1.273
barium bromide	3.92		
glucose			0.983
sodium acetate		2.42	

5. What is the concentration of each species present in the following aqueous solutions?
 1. 0.489 mol of NiSO_4 in 600 mL of solution
 2. 1.045 mol of magnesium bromide in 500 mL of solution
 3. 0.146 mol of glucose in 800 mL of solution
 4. 0.479 mol of CeCl_3 in 700 mL of solution

6. What is the concentration of each species present in the following aqueous solutions?
 1. 0.324 mol of K_2MoO_4 in 250 mL of solution
 2. 0.528 mol of potassium formate in 300 mL of solution
 3. 0.477 mol of KClO_3 in 900 mL of solution
 4. 0.378 mol of potassium iodide in 750 mL of solution
7. What is the molar concentration of each solution?
 1. 8.7 g of calcium bromide in 250 mL of solution
 2. 9.8 g of lithium sulfate in 300 mL of solution
 3. 12.4 g of sucrose ($\text{C}_{12}\text{H}_{22}\text{O}_{11}$) in 750 mL of solution
 4. 14.2 g of iron(III) nitrate hexahydrate in 300 mL of solution
8. What is the molar concentration of each solution?
 1. 12.8 g of sodium hydrogen sulfate in 400 mL of solution
 2. 7.5 g of potassium hydrogen phosphate in 250 mL of solution
 3. 11.4 g of barium chloride in 350 mL of solution
 4. 4.3 g of tartaric acid ($\text{C}_4\text{H}_6\text{O}_6$) in 250 mL of solution
9. Give the concentration of each reactant in the following equations, assuming 20.0 g of each and a solution volume of 250 mL for each reactant.
 1. $\text{BaCl}_2(\text{aq}) + \text{Na}_2\text{SO}_4(\text{aq}) \rightarrow$
 2. $\text{Ca}(\text{OH})_2(\text{aq}) + \text{H}_3\text{PO}_4(\text{aq}) \rightarrow$
 3. $\text{Al}(\text{NO}_3)_3(\text{aq}) + \text{H}_2\text{SO}_4(\text{aq}) \rightarrow$
 4. $\text{Pb}(\text{NO}_3)_2(\text{aq}) + \text{CuSO}_4(\text{aq}) \rightarrow$
 5. $\text{Al}(\text{CH}_3\text{CO}_2)_3(\text{aq}) + \text{NaOH}(\text{aq}) \rightarrow$
10. An experiment required 200.0 mL of a 0.330 M solution of Na_2CrO_4 . A stock solution of Na_2CrO_4 containing 20.0% solute by mass with a density of 1.19 g/cm^3 was used to prepare this solution. Describe how to prepare 200.0 mL of a 0.330 M solution of Na_2CrO_4 using the stock solution.
11. Calcium hypochlorite [$\text{Ca}(\text{OCl})_2$] is an effective disinfectant for clothing and bedding. If a solution has a $\text{Ca}(\text{OCl})_2$ concentration of 3.4 g per 100 mL of solution, what is the molarity of hypochlorite?
12. Phenol ($\text{C}_6\text{H}_5\text{OH}$) is often used as an antiseptic in mouthwashes and throat lozenges. If a mouthwash has a phenol concentration of 1.5 g per 100 mL of solution, what is the molarity of phenol?
13. If a tablet containing 100 mg of caffeine ($\text{C}_8\text{H}_{10}\text{N}_4\text{O}_2$) is dissolved in water to give 10.0 oz of solution, what is the molar concentration of caffeine in the solution?
14. A certain drug label carries instructions to add 10.0 mL of sterile water, stating that each milliliter of the resulting solution will contain 0.500 g of medication. If a patient has a prescribed dose of 900.0 mg, how many milliliters of the solution should be administered?

Answers

1. a. 39.13 g b. 161.0 g c. 93.57 g d. 201.8 g
- 2.
3. a. 1.40 L of a 0.334 M solution, b. 25.0 mL of a 0.134 M solution, c. 150 mL of a 0.769 M solution
- 4.
5. a. 0.815 M, b. 2.09 M, c. 0.182 M, d. 0.684 M
- 6.
7. a. 0.174 M, b. 0.297 M, c. 0.048 M, d. 0.135 M
- 8.
9. a. $\text{BaCl}_2 = 0.384 \text{ M}$, $\text{Na}_2\text{SO}_4 = 0.563 \text{ M}$, b. $\text{Ca}(\text{OH})_2 = 1.08 \text{ M}$, $\text{H}_3\text{PO}_4 = 0.816 \text{ M}$, c. $\text{Al}(\text{NO}_3)_3 = 0.376 \text{ M}$, $\text{H}_2\text{SO}_4 = 0.816 \text{ M}$, d. $\text{Pb}(\text{NO}_3)_2 = 0.242 \text{ M}$, $\text{CuSO}_4 = 0.501 \text{ M}$, e. $\text{Al}(\text{CH}_3\text{CO}_2) = 0.392 \text{ M}$, $\text{NaOH} = 2.00 \text{ M}$
- 10.
11. 0.48 M ClO^-
- 12.
13. $1.74 \times 10^{-3} \text{ M caffeine}$

Section 8.11: References

- Chung (Peter) Chieh (2016) Inorganic Chemistry. **Libretexts**. Available at: https://chem.libretexts.org/Core/Inorganic_Chemistry/Chemical_Reactions/Chemical_Reactions_1/Solutions
- Ball, D.W., Hill, J.W., and Scott, R.J. (2016) **MAP: The Basics of General, Organic and Biological Chemistry**. Libre Texts. Available at: [https://chem.libretexts.org/Textbook_Maps/Introductory_Chemistry_Textbook_Maps/Map%3A_The_Basics_of_GOB_Chemistry_\(Ball_et_al.\)](https://chem.libretexts.org/Textbook_Maps/Introductory_Chemistry_Textbook_Maps/Map%3A_The_Basics_of_GOB_Chemistry_(Ball_et_al.))
- Averill, B.A., Eldredge, P. (2012) **The Principles of Chemistry**. Libre Texts. Available at: <https://2012books.lardbucket.org/books/principles-of-general-chemistry-v1.0/index.html>
- Hydrate. (2017, August 30). In *Wikipedia, The Free Encyclopedia*. Retrieved 16:20, September 26, 2017, from <https://en.wikipedia.org/w/index.php?title=Hydrate&oldid=798015169>
- Lower, S. (2010). Solutions 1: Solutions and their concentrations. **In the Online textbook, "Chem1 Virtual Textbook"**. Available at: <http://www.chem1.com/acad/webtext/solut/solut-1.html>
- OpenStax, Chemistry. OpenStax CNX. Jun 20, 2016 <http://cnx.org/contents/85abf193-2bd2-4908-8563-90b8a7ac8df6@9.311>.

- Open Textbooks for Hong Kong. (2015) Tonicity chapter from Concepts in Biology. retrieved on Dec 31st, 2018 from <http://www.opentextbooks.org.hk/ditatopic/34633>
- Rice University () Section 3.1 The Cell Membrane from Anatomy and Physiology. BC Open Textbook Collection. Retrieved on Dec 31st, 2018 from <https://opentextbc.ca/anatomyandphysiology/chapter/the-cell-membrane/>
- Kahn Academy (2019) Homeostasis. In Human Body Systems. Retrieved on Jan 2nd, 2019 from <https://www.khanacademy.org/science/high-school-biology/hs-human-body-systems/hs-body-structure-and-homeostasis/a/homeostasis>
- Lumen Learning (2019) Homeostasis from Boundless Anatomy and Physiology. Retrieved on Jan 2nd, 2019 from <https://courses.lumenlearning.com/boundless-ap/chapter/homeostasis/>
- Wikipedia contributors. (2019, February 9). Hypothermia. In *Wikipedia, The Free Encyclopedia*. Retrieved 18:47, February 25, 2019, from <https://en.wikipedia.org/w/index.php?title=Hypothermia&oldid=882437028>